



FRENEX
PROFESSIONAL REFRIGERATION

PRODUCT CATALOG

ÜRÜN KATALOĞU

2025
2026

Price List
Fiyat Listesi

Yeni Ürünler New Products



Sayfa / Page

18

EF Serisi Monoblok 1 Kapılı
EF Series Mono Block 1 Door

Sayfa / Page

20

Dikey Buzdolapları - 1 Kapılı
Yatay GN 2/1
Vertical Refrigerators - SideWay
GN 2/1



Sayfa / Page

22

Dikey Buzdolapları - Özel Hava Dolaşımı
Vertical Refrigerators - Special Airflow

Yeni Ürünler New Products

Sayfa / Page

26

EF Serisi Monoblok 2 Kapılı
EF Series Mono Block 2 Door



Sayfa / Page

42

EF Serisi Yatay
Buzdolapları 2 Kapılı
EF Series Counter Type
Refrigerators 2 Door



Sayfa / Page

46

EF Serisi Yatay Buzdolapları
3 Kapılı
EF Series Counter Type
Refrigerators 3 Door



Sayfa / Page

50

EF Serisi Yatay Buzdolapları
4 Kapılı
EF Series Counter Type
Refrigerators 4 Door



Yeni Ürünler New Products



Sayfa / Page

58

Cihaz Altı Buzdolapları / Statik Soğutmalı
Undercounter Refrigerators / Static Cooled

Sayfa / Page

62

EF Serisi Cihaz Altı Buzdolapları
EF Series Undercounter
Refrigerators



Sayfa / Page

76

EF Serisi Dikey Buzdolabı
1 Kapılı - Prof Line
EF Series Vertical Refrigerators
1 Door - Prof Line

Yeni Ürünler New Products

Sayfa / Page

80

EF Serisi Dikey Buzdolabı
2 Kapılı - Prof Line
EF Series Vertical Refrigerators
2 Door - Prof Line



Sayfa / Page

94

Cihaz Altı Serisi
Chef Bases Series



Sayfa / Page

110

İventörlü Mono Blok 1 Kapılı
Buzdolabı/Prof. Line
Vertical Refrigerators Mono
Block 1 Door/Prof. Line



Yeni Ürünler New Products



Sayfa / Page

112

**İnventörlü Mono Blok 2
Kapılı Buzdolabı/Prof. Line**
Vertical Refrigerators 2
Door/Prof. Line

Sayfa / Page

128

**Bira Soğutucu Buzdolabı -
Tek Evyeli**
Keg Refrigerator -
One Sink



Sayfa / Page

130

**Bira Soğutucu Buzdolabı
- Çift Evyeli**
Keg Refrigerator - Double Sink



Yeni Ürünler New Products

Sayfa / Page

144

Şişe Soğutucu - Arkası Kapılı
Bottle Coolers - With Back Door



Sayfa / Page

160

**Yatay Panel Buzdolabı - 60 -
(Vakum Çekmece / Kapı İle)**
Counter Panel Refrigerator - 60
- (With Vacuum Drawer / Door)



Sayfa / Page

162

Yatay Panel Nötr Dolap
Counter Panel Neutral
Cabinet



Yeni Ürünler New Products



Sayfa / Page

176

Şarap Buzdolabı
Wine Cabinets

Sayfa / Page

188

Özel Ölçüde Camlı Şarap Buzdolabı
Custom Size Glass Wine Cabinets

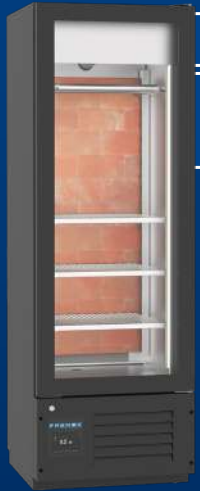

Sayfa / Page

206

Dry Age Buzdolapları
Dry Age Refrigerators

Yeni Ürünler New Products



Sayfa / Page

264

Yatay Servis Serisi Buzdolapları
Suşi Ünitesi
Counter Service Refrigerators
Sushi Unit

Üst Tabla Opsiyonları Work Top Options

- DZ** Düz Üst Tabla
Straight Work Top
- A** 10 cm Yuvarlatılmış Sırtlı Tabla
10 cm Curved Splashback Work Top
- GR** Granit Üst Tabla
Granite Work Top
- MR** Mermer Üst Tabla
Marble Work Top
- PL** Polietilen Üst Tabla
Polyethylene Work Top
- F** Üst Tablasız
Without Work Top
- SD** Özel Ölçü Tabla
Special Dimension Work Top
- RD** Yuvarlatılmış Üst Tabla
Curved Work Top

Dijital Kontrol Opsiyonları Digital Control Options

- TB** Touch Dijital/Blast Freezer
Touch Digital/Blast Freezer
- T** Touch Dijital
Touch Digital
- BT** Bluetooth Dijital
Bluetooth Digital
- WP** Su Geçirmez Dijital
Water Proof Digital
- MD** Medikal Dijital
Medical Digital

Diğer Opsiyonlar Other Options

- G** Cam Kapı
Glass Door
- SL** Sürgü Cam Kapı
Sliding Glass Door
- K** Kilitli Kapı
With Lock
- W** Tekerlekli
Wheels
- 2** Yarım Kapı
Half Door
- SH** Kısa Motor
Short Motor
- 60^{hz}** 220 V / 60 hz
- M** Monoblok Soğutma Grubu
Monoblock Cooling Group
- EV** Kabin İçi Evaporatör
Evaporator Inside Cabinet
- PA** Modüler Panel Buzdolabı
Modular Panel Refrigerator
- L** Sol Motor (Yatay) Left Motor (Counter)
Sol Kapı (Dikey) Left Door (Upright)
- ST** Statik Soğutma
Static Cooling
- GRN** Energy Efficiency Prof.Line
- EF** Energy Efficiency Enerji Tasarruflu

- KF** Fanlı Kanopi / Canopy With Fan

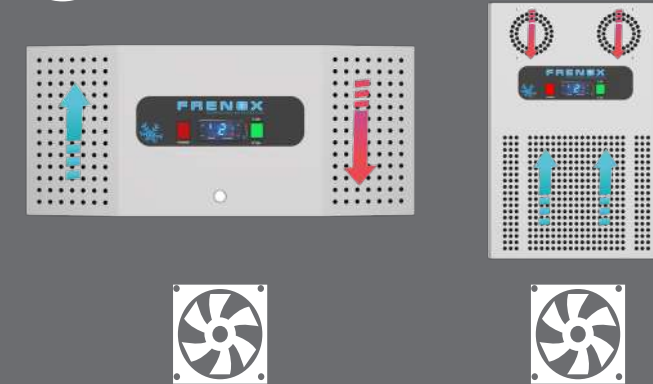

Dar Bölgelerde Motor Grubunun Rahat Çalışabilmesi İçin Ön Kanopiye Fan Takılabilir

In Narrow Spaces we can Put a Fan to The Canopy to have The Motor Group Working Better

Dik Buzdolapları Görüntü Opsiyonları

Vertical Refrigerators Display Options

Standart Görünüm
Standard Appearance



VN7-M



VN7-M-T



VN7-M-WP



VN7-M-BT

V

V Görünüm
V Appearance



VN7-M-V



VN7-M-V-T



VN7-M-V-WP



VN7-M-V-BT

SE

SE Görünüm
SE Appearance



VN9-M-SE



VN9-M-SE-T

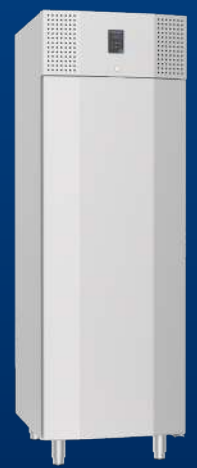

VN9-M-SE-WP

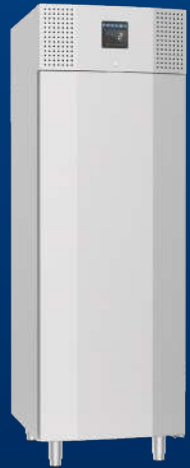

VN9-M-SE-BT

Yatay Buzdolapları Görüntü Opsiyonları

Counter Type Refrigerators Display Options

V

V Görünüm / V Appearance



CGN2-M-V



CGN2-M-V-T



CGN2-M-V-WP



CGN2-M-V-BT

Yatay Buzdolapları
Profesyonel Seri
Counter Refrigerator
Professional Series



CGN2-M



CGN2-M-T



CGN2-M-WP



CGN2-M-BT

Standart Üretim 6 cm Sırtlı Üst Tablalıdır.
Standard Production is With 6 cm Splashback Worktop.

Standart Üretim 10 cm Sırtlı Yuvarlak Üst Tablalıdır.
Standard Production is With 10 cm Splashback Curved Worktop.



Dikey Buzdolapları - Mono Blok 1 Kapılı
Vertical Refrigerators - Mono Block 1 Door

16-17
18-19

20-21
22-23

Dikey Buzdolapları - 1 Kapılı Yatay GN 2/1
Vertical Refrigerators - Side Way GN 2/1



Snack Dikey Buzdolapları 1 Kapılı
Snack Vertical Refrigerators 1 Door

24-25

26-27
28-29

Dikey Buzdolapları - Mono Blok 2 Kapılı
Vertical Refrigerators - Mono Block 2 Door



Snack Dikey Buzdolapları 2 Kapılı
Snack Vertical Refrigerators 2 Doors

30-31

32-33

Dikey Buzdolapları Snack Serisi 1 Kapılı
Vertical Refrigerators Snack Series 1 Door



400 Litre Buzdolapları 1 Kapılı
400 Litre Refrigerators 1 Door

34-35

36-37

Teşhir Buzdolapları 1 Kapılı
Doors Display Refrigerators 1 Door



Teşhir Buzdolapları 2 Kapılı
Doors Display Refrigerators 2 Doors

38-39

40-41

Yatay Buzdolapları 1 Kapılı
Counter Type Refrigerators 1 Door



42-43
44-45

Yatay Buzdolapları 2 Kapılı
Counter Type Refrigerators 2 Door



Yatay Buzdolapları 3 Kapılı
Counter Type Refrigerators 3 Door

46-47
48-49

50-51
52-53

Yatay Buzdolapları 4 Kapılı
Counter Type Refrigerators 4 Door



Yatay Buzdolapları-Sürgü Cam Kapılı
Counter Type Refrigerators-Sliding Glass Door

54-55

56-57

Yatay Buzdolapları - Kısa
Counter Type Refrigerators - Short



Evyeli Yatay Buzdolapları
Counter Type Refrigerators W/Sink

58-59

60-61

Cihaz Altı Buzdolapları / Statik Soğutmalı
Undercounter Refrigerators / Static Cooled



Cihaz Altı Buzdolapları
Undercounter Refrigerators

62-63
64-65

66-67
68-69

Cihaz Altı Buzdolapları-Kısa
Undercounter Refrigerators-Short



Yatay Buzdolapları - Remote
Counter Type Refrigerators - Remote

70-71

72-73

Yatay Buzdolapları Bar Seviyesi
Counter Refrigerators Bar Series



Dikey Buzdolapları - Mono Blok 1 Kapılı

Vertical Refrigerators - Mono Block 1 Door



GN 2/1

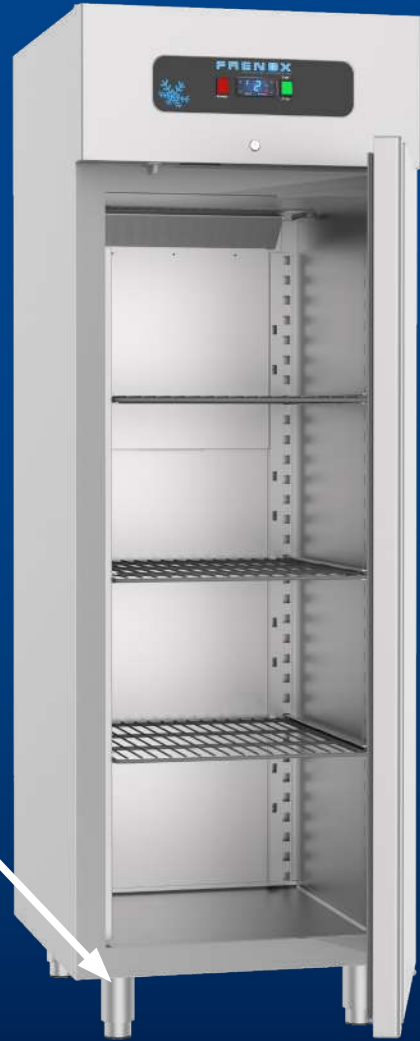

Option : 189 €

115 V / 60 Hz

31 Adet Raf Kapasitesi.
4,5 cm Aralıklı.
31 Unit Shelf Holder Capacity.
4,5 cm Spaced.

KF



89 €

Fanlı Kanopi
Canopy With Fan

FP
Ayak Pedalı
Opsiyonu
Foot Pedal
Options

90€

VN7-M

FRENOX
PROFESSIONAL REFRIGERATION

Standard Line Series

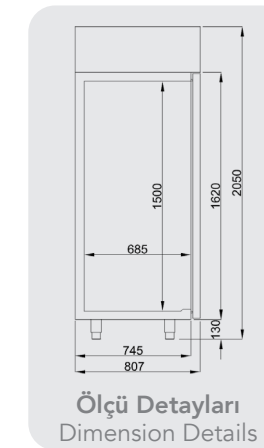

Ölçü Detayları
Dimension Details



Monoblok Soğutma Sistemi
Monoblock Cooling Group



Ekstra Kuvvetli Dayanıklı Fanlar Yüksek Hava Akışı
Strong Fans with maximum air speed

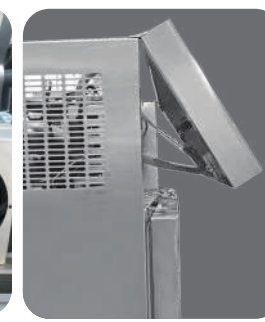

Açılabilir Kanopiyle Kolay Müdahale Olanağı
Front Cover Can be Opened For Easy Access

Bilgi

- * İç Derinlik: 65 Cm (GN 2/1 Kapasiteli)
- * 35-40 Kg/m³ Gazlı Çevre Dostu HCFC İçermeyen Poliüretan İzolasyon
- * Dijital Kumanda Paneli
- * Otomatik Su Buharlaştırma Sistemi
- * Elektrikli Otomatik Defrost
- * Yüksekliği Ayarlanabilir Paslanmaz Ayaklar
- * Kapı Açıldığında Otomatik İç Aydınlatma
- * Özel, Kapı Menteşe Sistemi
- * Temizlenebilir ve Sökülebilir Manyetik Kapı Contası
- * Dış Ortam Sıcaklığı: + 43°C & % 65 Nem

Info

- * Inside Depth: 65 Cm (GN 2/1 Capacity)
- * 35-40 Kg/m³ Ecology Friendly HCFC Free Polyurethane Insulation
- * Digital Control Panel
- * Automatic Water Evaporation System
- * Electrical Automatic Defrost
- * Stainless Steel Legs Adjustable For Height
- * Automatic Lighting Inside When Door is Open
- * Special Door and Hinge Systems
- * Removable and Easy Cleaning Magnetic Gaskets
- * Ambient Temperature: + 43°C & % 65 Humidity

Kod Özellikleri
Available Codes

Raf ve Raf Kızağı
Shelf and Shelf Holder 49 €

W
Tekerlekli / Wheels 90 €

T
Touch Dijital
Touch Digital 217 €

SE
Görüntü
Appearance 56 €

WP
Su Geçirmez Dijital
Water Proof Digital 137 €

-2
Yarım Kapı
Half Door 197 €

BT
Wi-Fi Dijital
Wi-Fi Digital 418 €

L
Sol Kapı (Dikey)
Left Door (Upright) 30 €

60_{hz}
220 V / 60 hz 56 €

LED
LED Aydınlatma
LED Lighting 85 €

Model Models	İç Sıcaklık Temperature °C	Brüt Hacim Gross volume Lt.	Ölçüler Dimensions Cm.	Paket Ölçüsü Packing Dim. Cm.	Ağırlık Weight Kg.	Paslanmaz Özellikler Stainless Steel Type
	VN7-M	-2/+8	700	70x81x205	80x85x220	304
	VL7-M	-10/-22	700	70x81x205	80x85x220	304
	BN7-M	-2/+8	700	70x81x205	80x85x220	430
	BL7-M	-10/-22	700	70x81x205	80x85x220	430
	VN7-M-G	-2/+8	700	70x81x205	80x85x220	304
	VL7-M-G	-10/-22	700	70x81x205	80x85x220	304
	BN7-M-G	-2/+8	700	70x81x205	80x85x220	430
	BL7-M-G	-10/-22	700	70x81x205	80x85x220	430

İzolasyon Kalınlığı Insulation Thickness	Raf Adedi Shelf Unit	Soğutma Gazı Cooling Gas	Voltaj Voltage	Enerji Sınıfı Energy Rating	Kapı Adedi Door Unit	Fiyat Price €	Model Models	Fiyat Price
60 mm	3	R134A	220 V / 50 Hz	E	1	2.628 €	VN7-M-R290	2.600 €
60 mm	3	R404A	220 V / 50 Hz	E	1	3.277 €	VL7-M-R290	3.250 €
60 mm	3	R134A	220 V / 50 Hz	E	1	2.175 €	BN7-M-R290	2.148 €
60 mm	3	R404A	220 V / 50 Hz	E	1	2.759 €	BL7-M-R290	2.733 €
60 mm	3	R134A	220 V / 50 Hz	E	1	3.212 €	VN7-M-G-R290	3.185 €
60 mm	3	R404A	220 V / 50 Hz	E	1	3.899 €	VL7-M-G-R290	3.871 €
60 mm	3	R134A	220 V / 50 Hz	E	1	2.696 €	BN7-M-G-R290	2.669 €
60 mm	3	R404A	220 V / 50 Hz	E	1	3.434 €	BL7-M-G-R290	3.408 €

Dikey Buzdolapları - Mono Blok 1 Kapılı

Vertical Refrigerators - Mono Block 1 Door

B
ENERGY RATING

FP
Ayak Pedalı Opsiyonu
Foot Pedal Options

GN 2/1



ENERGY EFFICIENT
%63
R290

Option : 189 €

115 V / 60 Hz

31 Adet Raf Kapasitesi.
4,5 cm Aralıklı
31 Unit Shelf Holder Capacity.
4,5 cm Spaced.

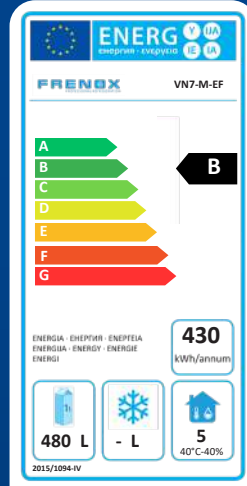

Elektrik Testi
EN ISO 22041:2019
Standartlarında yapılmıştır.

Electricity Consumption
Test is Hold Under EN ISO
22041:2019 Standard.

KF
89 €
Fanlı Kanopi
Canopy With Fan

10 Min.
MONOBLOCK REPLACEMENT



FRENOX
PROFESSIONAL REFRIGERATION

Standard Line Series

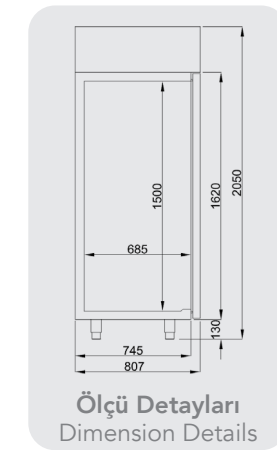

Ölçü Detayları
Dimension Details



Monoblok Soğutma Sistemi
Monoblock Cooling Group



Ekstra Kuvvetli Dayanıklı Fanlar Yüksek Hava Akışı
Strong Fans with maximum air speed



Açılabilir Kanopiyle Kolay Müdahale Olanakları
Front Cover Can be Opened For Easy Access

Bilgi

- * İç Derinlik: 65 Cm (GN 2/1 Kapasiteli)
- * 35-40 Kg/m³ Gazlı Çevre Dostu HCFC İçermeyen Poliüretan İzolasyon
- * Dijital Kumanda Paneli
- * Otomatik Su Buharlaştırma Sistemi
- * Elektrikli Otomatik Defrost
- * Yüksekliği Ayarlanabilir Paslanmaz Ayaklar
- * Kapı Açıldığında Otomatik İç Aydınlatma
- * Özel, Kapı Menteşe Sistemi
- * Temizlenebilir ve Sökülebilir Manyetik Kapı Contası
- * Dış Ortam Sıcaklığı: + 43°C & % 65 Nem

Info

- * Inside Depth: 65 Cm (GN 2/1 Capacity)
- * 35-40 Kg/m³ Ecology Friendly HCFC Free Polyurethane Insulation
- * Digital Control Panel
- * Automatic Water Evaporation System
- * Electrical Automatic Defrost
- * Stainless Steel Legs Adjustable For Height
- * Automatic Lighting Inside When Door is Open
- * Special Door and Hinge Systems
- * Removable and Easy Cleaning Magnetic Gaskets
- * Ambient Temperature: + 43°C & % 65 Humidity

Kod Özellikleri Available Codes

Raf ve Raf Kızağı
Shelf and Shelf Holder 49 €

W
Tekerlekli / Wheels 90 €

T
Touch Dijital
Touch Digital 217 €

SE
Görüntü
Appearance 56 €

WP
Su Geçirmez Dijital
Water Proof Digital 137 €

-2
Yarım Kapı
Half Door 197 €







BT
Wi-Fi Dijital
Wi-Fi Digital 418 €

L
Sol Kapı (Dikey)
Left Door (Upright) 30 €

60
220 V
60 hz 56 €

LED
LED Aydınlatma
LED Lighting 85 €

VN7-M-EF-R290

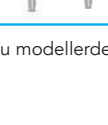
Model Models	İç Sıcaklık Temperature °C	Brüt Hacim Gross volume Lt.	Ölçüler Dimensions Cm.	Paket Ölçüsü Packing Dim. Cm.	Ağırlık Weight Kg.	Paslanmaz Özellikli Stainless Steel Type	
	VN7-M-EF-R290	0/+8	700	70x81x205	80x85x220	138	304
	VL7-M-EF-R290	-10/-22	700	70x81x205	80x85x220	145	304
	BN7-M-EF-R290	0/+8	700	70x81x205	80x85x220	138	430
	BL7-M-EF-R290	-10/-22	700	70x81x205	80x85x220	145	430
	VN7-M-G-EF-R290	0/+8	700	70x81x205	80x85x220	145	304
	VL7-M-G-EF-R290	-10/-22	700	70x81x205	80x85x220	160	304
	BN7-M-G-EF-R290	0/+8	700	70x81x205	80x85x220	145	430
	BL7-M-G-EF-R290	-10/-22	700	70x81x205	80x85x220	160	430

İzolasyon Kalınlığı Insulation Thickness	Raf Adedi Shelf Unit	Soğutma Gazı Cooling Gas	Voltaj Voltage	Enerji Sınıfı Energy Rating	Kapı Adedi Door Unit	Model Models	Fiyat Price
60 mm	4	R290	220 V / 50 Hz	B	1	VN7-M-EF-R290	2.675 €
60 mm	4	R290	220 V / 50 Hz	D	1	VL7-M-EF-R290	3.324 €
60 mm	4	R290	220 V / 50 Hz	B	1	BN7-M-EF-R290	2.223 €
60 mm	4	R290	220 V / 50 Hz	D	1	BL7-M-EF-R290	2.807 €
60 mm	4	R290	220 V / 50 Hz	C	1	VN7-M-G-EF-R290	3.259 €
60 mm	4	R290	220 V / 50 Hz	E	1	VL7-M-G-EF-R290	3.945 €
60 mm	4	R290	220 V / 50 Hz	C	1	BN7-M-G-EF-R290	2.743 €
60 mm	4	R290	220 V / 50 Hz	E	1	BL7-M-G-EF-R290	3.482 €

EF: Bu modellerde energy efficiency kondenser fanı kullanılmaktadır. / These models have energy efficiency condenser fans.

Dikey Buzdolapları - 1 Kapılı Yatay GN 2/1

Vertical Refrigerators - Side Way GN 2/1



Ayak Pedali
Opsiyonu
Foot Pedal
Options

90€

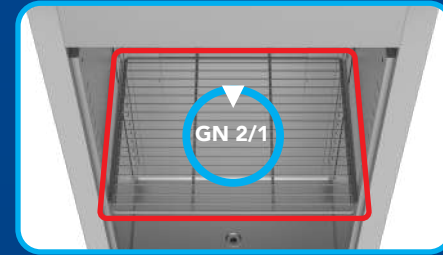

Daha Az Derinlik ile Daha Geniş
GN 2/1 Raf Yerleşim Sistemi
GN 2/1 Shelf Layout System with
Less Depth and More Width

Option : 189 €

115 V / 60 Hz

BN8-ISV



FRENOX
PROFESSIONAL REFRIGERATION

Standard Line Series

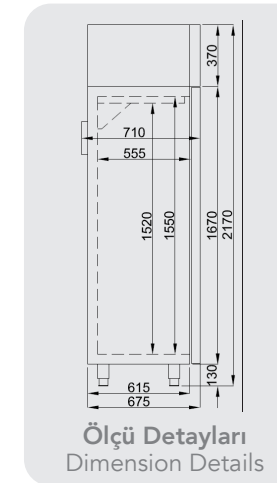

Ölçü Detayları
Dimension Details



Ekstra Kuvvetli Dayanıklı
Fanlar Yüksek Hava Akışı
Strong Fans with maximum
air speed



Açılabilir Kanopiyle Kolay
Müdahale Olanağı
Front Cover Can be
Opened For Easy Access

Bilgi

- * İç Derinlik: 55 Cm (GN 2/1 Kapasiteli)
- * Dijital Kumanda Paneli
- * Otomatik Su Buharlaştırma Sistemi
- * Elektrikli Otomatik Defrost
- * Yüksekliği Ayarlanabilir Paslanmaz Ayaklar
- * Kapı Açıldığında Otomatik İç Aydınlatma
- * Özel, Kapı Mentеше Sistemi
- * Temizlenebilir ve Sökülebilir Manyetik Kapı Contası
- * Dış Ortam Sıcaklığı: + 43°C & % 65 Nem

Info

- * Inside Depth: 55 Cm (GN 2/1 Capacity)
- * Digital Control Panel
- * Automatic Water Evaporation System
- * Electrical Automatic Defrost
- * Stainless Steel Legs Adjustable For Height
- * Automatic Lighting Inside When Door is Open
- * Special Door and Hinge Systems
- * Removable and Easy Cleaning Magnetic Gaskets
- * Ambient Temperature: + 43°C & % 65 Humidity

Kod Özellikleri Available Codes

Raf ve Raf Kızağı
Shelf and
Shelf
Holder 49 €

W
Tekerlekli / Wheels 90 €

T
Touch Dijital
Touch Digital 217 €

WP
Su Geçirmez Dijital
Water Proof Digital 137 €

-2
Yarım Kapı
Half Door 197 €

BT
Wi-Fi Dijital
Wi-Fi Digital 418 €

L
Sol Kapı
(Dikey)
Left Door
(Upright) 30 €

60_{hz}
220 V
60 hz
56 €

Model Models	İç Sıcaklık Temperature °C	Brüt Hacim Gross volume Lt.	Ölçüler Dimensions Cm.	Paket Ölçüsü Packing Dim. Cm.	Ağırlık Weight Kg.	Paslanmaz Özelliği Stainless Steel Type
	VN8-ISV-R290	-2/+8	800	82x71x217	83x80x232	195 304
	VL8-ISV-R290	-10/-22	800	82x71x217	83x80x232	195 304
	BN8-ISV-R290	-2/+8	800	82x71x217	83x80x232	195 430
	BL8-ISV-R290	-10/-22	800	82x71x217	83x80x232	195 430
	VN8-ISV-G-R290	-2/+8	800	82x71x217	83x80x232	210 304
	VL8-ISV-G-R290	-10/-22	800	82x71x217	83x80x232	210 304
	BN8-ISV-G-R290	-2/+8	800	82x71x217	83x80x232	210 430
	BL8-ISV-G-R290	-10/-22	800	82x71x217	83x80x232	210 430

İzolasyon Kalınlığı Insulation Thickness	Raf Adedi Shelf Unit	Soğutma Gazı Cooling Gas	Voltaj Voltage	Enerji Sınıfı Energy Rating	Kapı Adedi Door Unit	Model Models	Fiyat Price
60 mm	3	R290	220 V / 50 Hz	E	1	VN8-ISV-R290	2.742 €
60 mm	3	R290	220 V / 50 Hz	E	1	VL8-ISV-R290	3.548 €
60 mm	3	R290	220 V / 50 Hz	E	1	BN8-ISV-R290	2.492 €
60 mm	3	R290	220 V / 50 Hz	E	1	BL8-ISV-R290	3.226 €
60 mm	3	R290	220 V / 50 Hz	E	1	VN8-ISV-G-R290	2.842 €
60 mm	3	R290	220 V / 50 Hz	E	1	VL8-ISV-G-R290	3.748 €
60 mm	3	R290	220 V / 50 Hz	E	1	BN8-ISV-G-R290	2.592 €
60 mm	3	R290	220 V / 50 Hz	E	1	BL8-ISV-G-R290	3.426 €

Dikey Buzdolapları - Özel Hava Dolaşımı

Vertical Refrigerators - Special Airflow

Option : 189 €

115 V / 60 Hz

FP

90€

Ayak Pedalı
Opsiyonu
Foot Pedal
Options

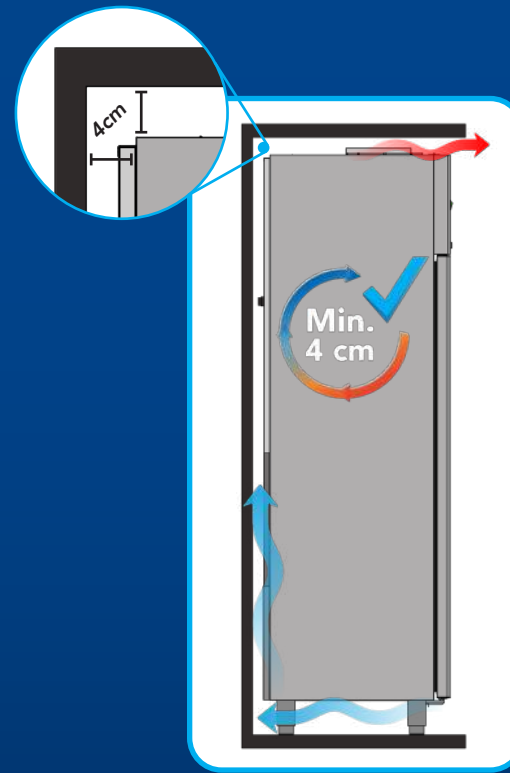

Dar alanlar için tasarlanmış kompakt bir soğutma sistemi. Arka panelden hava alıp üstten dışarı vererek, "min. 4 cm" boşlukta bile verimli hava sirkülasyonu sağlar.

A compact cooling system designed for tight spaces. By taking in air from the back panel and exhausting it from the top, it provides efficient air circulation even with "min. 4 cm" of space for efficient air circulation.

BN8-ISV-AF

FRENOX
PROFESSIONAL REFRIGERATION

Standard Line Series

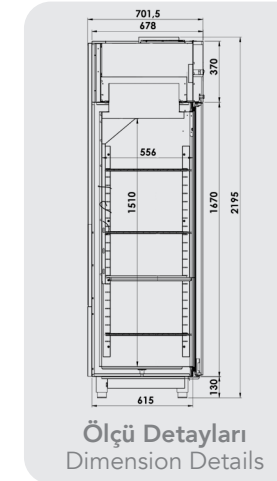

Ölçü Detayları
Dimension Details



Alttan Soğuk Havayı Emen
Özel Soğutma Sistemi
Special Cooling System that
Takes in Cold Air from Below

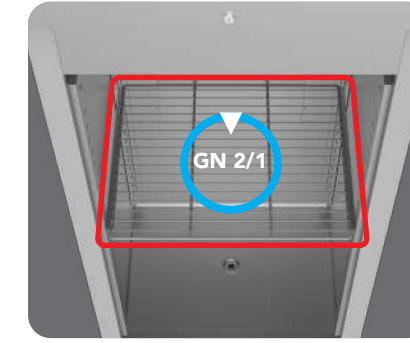

Daha Az Derinlik ile Daha Geniş
GN 2/1 Raf Yerleşim Sistemi
GN 2/1 Shelf Layout System
with Less Depth and More Width

Bilgi

- * İç Derinlik: 55 Cm (GN 2/1 Kapasiteli)
- * Dijital Kumanda Paneli
- * Otomatik Su Buharlaştırma Sistemi
- * Elektrikli Otomatik Defrost
- * Yüksekliği Ayarlanabilir Paslanmaz Ayaklar
- * Kapı Açıldığında Otomatik İç Aydınlatma
- * Özel, Kapı Mentеше Sistemi
- * Temizlenebilir ve Sökülebilir Manyetik Kapı Contası
- * Dış Ortam Sıcaklığı: + 43°C & % 65 Nem

Info

- * Inside Depth: 55 Cm (GN 2/1 Capacity)
- * Digital Control Panel
- * Automatic Water Evaporation System
- * Electrical Automatic Defrost
- * Stainless Steel Legs Adjustable For Height
- * Automatic Lighting Inside When Door is Open
- * Special Door and Hinge Systems
- * Removable and Easy Cleaning Magnetic Gaskets
- * Ambient Temperature: + 43°C & % 65 Humidity

Kod Özellikleri Available Codes

Raf ve Raf Kızağı
Shelf and
Shelf
Holder 49 €

W
Tekerlekli / Wheels 90 €

T
Touch Dijital
Touch Digital 217 €

WP
Su Geçirmez Dijital
Water Proof Digital 137 €

-2
Yarım Kapı
Half Door 197 €

BT
Wi-Fi Dijital
Wi-Fi Digital 418 €

L
Sol Kapı
(Dikey)
Left Door
(Upright) 30 €

60_{hz}
220 V
60 hz
56 €

Model Models	İç Sıcaklık Temperature °C	Brüt Hacim Gross volume Lt.	Ölçüler Dimensions Cm.	Paket Ölçüsü Packing Dim. Cm.	Ağırlık Weight Kg.	Paslanmaz Özelliği Stainless Steel Type	
	VN8-ISV-AF-R290	-2/+8	800	82x70x217	83x80x232	195	304
	VL8-ISV-AF-R290	-10/-22	800	82x70x217	83x80x232	205	304
	BN8-ISV-AF-R290	-2/+8	800	82x70x217	83x80x232	195	430
	BL8-ISV-AF-R290	-10/-22	800	82x70x217	83x80x232	205	430
	VN8-ISV-AF-G-R290	-2/+8	800	82x70x217	83x80x232	210	304
	VL8-ISV-AF-G-R290	-10/-22	800	82x70x217	83x80x232	220	304
	BN8-ISV-AF-G-R290	-2/+8	800	82x70x217	83x80x232	210	430
	BL8-ISV-AF-G-R290	-10/-22	800	82x70x217	83x80x232	220	430

İzolasyon Kalınlığı Insulation Thickness	Raf Adedi Shelf Unit	Soğutma Gazı Cooling Gas	Volтаж Voltage	Enerji Sınıfı Energy Rating	Kapı Adedi Door Unit	Model Models	Fiyat Price
60 mm	3	R290	220 V / 50 Hz	E	1	VN8-ISV-AF-R290	3.481 €
60 mm	3	R290	220 V / 50 Hz	E	1	VL8-ISV-AF-R290	4.699 €
60 mm	3	R290	220 V / 50 Hz	E	1	BN8-ISV-AF-R290	3.158 €
60 mm	3	R290	220 V / 50 Hz	E	1	BL8-ISV-AF-R290	4.263 €
60 mm	3	R290	220 V / 50 Hz	E	1	VN7-ISV-AF-G-R290	3.581 €
60 mm	3	R290	220 V / 50 Hz	E	1	VL7-ISV-AF-G-R290	4.899 €
60 mm	3	R290	220 V / 50 Hz	E	1	BN7-ISV-AF-G-R290	3.258 €
60 mm	3	R290	220 V / 50 Hz	E	1	BL7-ISV-AF-G-R290	4.463 €

Snack Dikey Buzdolapları 1 Kapılı

Snack Vertical Refrigerators 1 Door

GN 2/1

FP

90€

Ayak Pedali Opsiyonu
Foot Pedal Options



Option : 189 €

115 V / 60 Hz

29 Adet Raf Kapasitesi.
4,5 cm Aralıklı.
29 Unit Shelf Holder Capacity.
4,5 cm Spaced.

KF



89 €

Fanlı Kanopi
Canopy With Fan

VN6

FRENOX
PROFESSIONAL REFRIGERATION

Standard Line Series

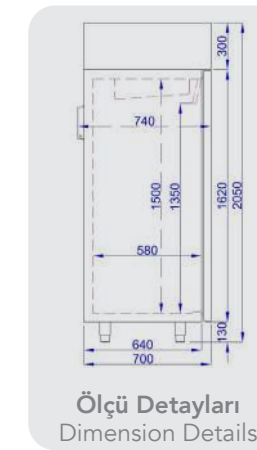

Ölçü Detayları
Dimension Details



Her Ürün İçin
10 Saatlik
Performans Testi
10 Hours
performance testing

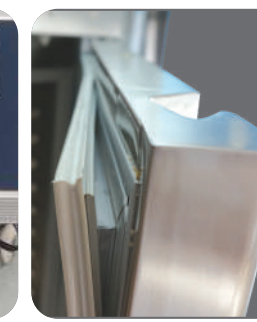

Değiştirilebilir Arasında Kir
ve Bakteri Tutmayan Yüksek
Manyetik Çekimli ÖZEL
Conta
Special designed new gaskets.
Can be removed, dirt-free



Açılabilir Kanopiyle
Kolay Müdahale Olanağı
Front Cover Can be
Opened For Easy Access

Kod Özellikleri
Available Codes

Raf ve Raf Kızağı
Shelf and
Shelf
Holder 49 €

W
Tekerlekli / Wheels 90 €

T
Touch Dijital
Touch Digital 217 €

SE
Görüntü
Appearance 56 €

WP
Su Geçirmez Dijital
Water Proof Digital 137 €

-2
Yarım Kapı
Half Door 197 €

BT
Wi-Fi Dijital
Wi-Fi Digital 418 €

L
Sol Kapı
(Dikey)
Left Door
(Upright) 30 €

60_{hz}
220 V
60 hz 56 €

LED
LED Aydınlatma
LED Lighting 85 €

Bilgi

- * 35-40 Kg/m³ Gazlı Çevre Dostu HCFC İçermeyen Poliüretan İzolasyon
- * Dijital Kumanda Paneli
- * Otomatik Su Buharlaştırma Sistemi
- * Otomatik Defrost
- * Yüksekliği Ayarlanabilir Paslanmaz Ayaklar
- * Kapı Açıldığında Otomatik İç Aydınlatma
- * Özel, Kapı Menteşe Sistemi
- * Temizlenebilir ve Sökülebilir Manyetik Kapı Contası
- * Dış Ortam Sıcaklığı: + 43°C & % 65 Nem

Info

- * 35-40 Kg/m³ Ecology Friendly HCFC Free Polyurethane Insulation
- * Digital Control Panel
- * Automatic Water Evaporation System
- * Automatic Defrost
- * Stainless Steel Legs Adjustable For Height
- * Automatic Lighting Inside When Door is Open
- * Special Door and Hinge Systems
- * Removable and Easy Cleaning Magnetic Gaskets
- * Ambient Temperature: + 43°C & % 65 Humidity

İzolasyon Kalınlığı Insulation Thickness	Raf Adedi Shelf Unit	Soğutma Gazı Cooling Gas	Voltaj Voltage	Enerji Sınıfı Energy Rating	Kapı Adedi Door Unit	Fiyat Price €	Model Models	Fiyat Price
60 mm	3	R134A	220 V / 50 Hz	E	1	2.584 €	VN6-R290	2.556 €
60 mm	3	R404A	220 V / 50 Hz	E	1	3.094 €	VL6-R290	3.066 €
60 mm	3	R134A	220 V / 50 Hz	E	1	2.103 €	BN6-R290	2.077 €
60 mm	3	R404A	220 V / 50 Hz	E	1	2.639 €	BL6-R290	2.613 €
60 mm	3	R134A	220 V / 50 Hz	E	1	3.109 €	VN6-G-R290	3.081 €
60 mm	3	R404A	220 V / 50 Hz	E	1	3.929 €	VL6-G-R290	3.902 €
60 mm	3	R134A	220 V / 50 Hz	E	1	2.568 €	BN6-G-R290	2.542 €
60 mm	3	R404A	220 V / 50 Hz	E	1	3.308 €	BL6-G-R290	3.282 €

Model Models	İç Sıcaklık Temperature °C	Brüt Hacim Gross volume Lt.	Ölçüler Dimensions Cm.	Paket Ölçüsü Packing Dim. Cm.	Ağırlık Weight Kg.	Paslanmaz Özelliği Stainless Steel Type	
	VN6	-2/+8	550	70x71x205	80x80x220	133	304
	VL6	-10/-22	550	70x71x205	80x80x220	138	304
	BN6	-2/+8	550	70x71x205	80x80x220	133	430
	BL6	-10/-22	550	70x71x205	80x80x220	141	430
	VN6-G	-2/+8	550	70x71x205	80x80x220	140	304
	VL6-G	-10/-22	550	70x71x205	80x80x220	150	304
	BN6-G	-2/+8	550	70x71x205	80x80x220	140	430
	BL6-G	-10/-22	550	70x71x205	80x80x220	150	430

Dikey Buzdolapları - Mono Blok 2 Kapılı

Vertical Refrigerators - Mono Block 2 Door



Standard Line Series

GN 2/1



Option : 189 €

115 V / 60 Hz

62 Adet Raf Kapasitesi.
4,5 cm Aralıklı.
62 Unit Shelf Holder Capacity.
4,5 cm Spaced.

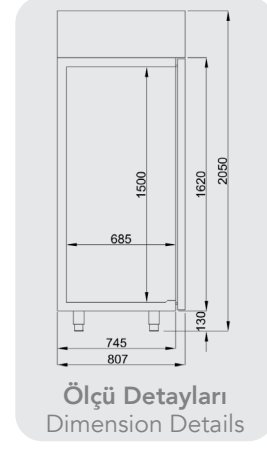

Ölçü Detayları
Dimension Details



Monoblok Soğutma Sistemi
Monoblock Cooling Group



Ekstra Kuvvetli Dayanıklı Fanlar Yüksek Hava Akışı
Strong Fans with maximum air speed



Açılabilir Kanopiyle Kolay Müdahale Olanağı
Front Cover Can be Opened For Easy Access

Kod Özellikleri Available Codes

Raf ve Raf Kızağı
Shelf and Shelf Holder 49 €

W Tekerlekli / Wheels 90 €

T Touch Dijital
Touch Digital 217 €

SE Görüntü
Appearance 56 €

WP Su Geçirmez Dijital
Water Proof Digital 137 €

-4 Yarım Kapı
Half Door 197 €

BT Wi-Fi Dijital
Wi-Fi Digital 418 €

60hz 220 V / 60 Hz 56 €

LED LED Aydınlatma
LED Lighting 85 €

FP

181€

Ayak Pedalı Opsiyonu
Foot Pedal Options

KF 89 €
Fanlı Kanopi
Canopy With Fan

Bilgi

- * İç Derinlik: 65 Cm (GN 2/1 Kapasiteli)
- * 35-40 Kg/m3 Gazlı Çevre Dostu HCFC İçermeyen Poliüretan İzolasyon
- * Dijital Kumanda Paneli
- * Otomatik Su Buharlaştırma Sistemi
- * Elektrikli Otomatik Defrost
- * Yüksekliği Ayarlanabilir Paslanmaz Ayaklar
- * Kapı Açıldığında Otomatik İç Aydınlatma
- * Özel, Kapı Menteşe Sistemi
- * Temizlenebilir ve Sökülebilir Manyetik Kapı Contası
- * Dış Ortam Sıcaklığı: + 43oC & % 65 Nem

Info

- * Inside Depth: 65 Cm (GN 2/1 Capacity)
- * 35-40 Kg/m3 Ecology Friendly HCFC Free Polyurethane Insulation
- * Digital Control Panel
- * Automatic Water Evaporation System
- * Electrical Automatic Defrost
- * Stainless Steel Legs Adjustable For Height
- * Automatic Lighting Inside When Door is Open
- * Special Door and Hinge Systems
- * Removable and Easy Cleaning Magnetic Gaskets
- * Ambient Temperature: + 43oC & % 65 Humidity

VN14-M

Model Models	İç Sıcaklık Temperature °C	Brüt Hacim Gross volume Lt.	Ölçüler Dimensions Cm.	Paket Ölçüsü Packing Dim. Cm.	Ağırlık Weight Kg.	Paslanmaz Özelliği Stainless Steel Type	
	VN14-M	-2/+8	1400	140x81x205	150x85x220	217	304
	VL14-M	-10/-22	1400	140x81x205	150x85x220	231	304
	BN14-M	-2/+8	1400	140x81x205	150x85x220	217	430
	BL14-M	-10/-22	1400	140x81x205	150x85x220	231	430
	VN14-M-G	-2/+8	1400	140x81x205	150x85x220	232	304
	VL14-M-G	-10/-22	1400	140x81x205	150x85x220	260	304
	BN14-M-G	-2/+8	1400	140x81x205	150x85x220	232	430
	BL14-M-G	-10/-22	1400	140x81x205	150x85x220	260	430

İzolasyon Kalınlığı Insulation Thickness	Raf Adedi Shelf Unit	Soğutma Gazı Cooling Gas	Voltaj Voltage	Enerji Sınıfı Energy Rating	Kapı Adedi Door Unit	Fiyat Price €	Model Models	Fiyat Price
60 mm	6	R134A	220 V / 50 Hz	E	2	3.722 €	VN14-M-R290	3.694 €
60 mm	6	R404A	220 V / 50 Hz	E	2	4.947 €	VL14-M-R290	4.581 €
60 mm	6	R134A	220 V / 50 Hz	E	2	3.055 €	BN14-M-R290	3.029 €
60 mm	6	R404A	220 V / 50 Hz	E	2	4.238 €	BL14-M-R290	3.874 €
60 mm	6	R134A	220 V / 50 Hz	E	2	4.756 €	VN14-M-G-R290	4.729 €
60 mm	6	R404A	220 V / 50 Hz	E	2	6.499 €	VL14-M-G-R290	6.133 €
60 mm	6	R134A	220 V / 50 Hz	E	2	4.111 €	BN14-M-G-R290	4.085 €
60 mm	6	R404A	220 V / 50 Hz	E	2	5.716 €	BL14-M-G-R290	5.352 €

Dikey Buzdolapları - Mono Blok 2 Kapılı

Vertical Refrigerators - Mono Block 2 Door

B
ENERGY RATING



FP 181€

Ayak Pedali Opsiyonu
Foot Pedal Options

GN 2/1

10 Min.
MONOBLOCK REPLACEMENT



R290

Option : 189 €

115 V / 60 Hz

62 Adet Raf Kapasitesi.
4,5 cm Aralıklı.
62 Unit Shelf Holder Capacity.
4,5 cm Spaced.

KF



89 €

Fanlı Kanopi
Canopy With Fan

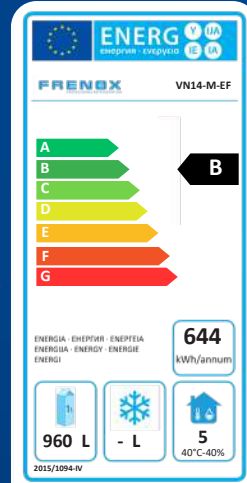

Elektrik Testi
EN ISO 22041:2019
Standartlarında yapılmıştır.
Electricity Consumption
Test is Hold Under EN ISO
22041:2019 Standard.



FRENEX
PROFESSIONAL REFRIGERATION

Standard Line Series

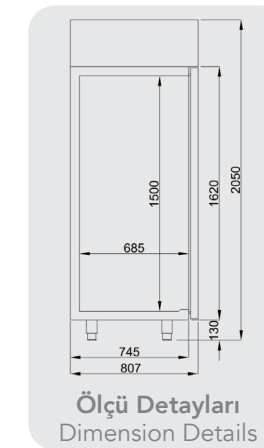

Ölçü Detayları
Dimension Details



Monoblok Soğutma Sistemi
Monoblock Cooling Group



Ekstra Kuvvetli Dayanıklı Fanlar Yüksek Hava Akışı
Strong Fans with maximum air speed

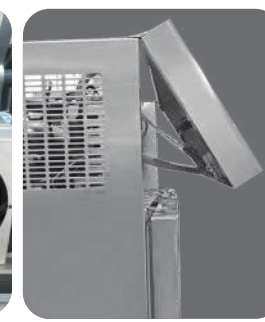

Açılabilir Kanopiyle Kolay Müdahale Olanağı
Front Cover Can be Opened For Easy Access

Kod Özellikleri
Available Codes

Raf ve Raf Kızağı
Shelf and Shelf Holder 49 €

W
Tekerlekli / Wheels 90 €

T
Touch Dijital
Touch Digital 217 €

SE
Görüntü
Appearance 56 €

WP
Su Geçirmez Dijital
Water Proof Digital 137 €

-4
Yarım Kapı
Half Door 394 €

BT
Wi-Fi Dijital
Wi-Fi Digital 418 €

60
220 V
60 hz 56 €

LED
LED Aydınlatma
LED Lighting 85 €

Bilgi

- * İç Derinlik: 65 Cm (GN 2/1 Kapasiteli)
- * 35-40 Kg/m³ Gazlı Çevre Dostu HCFC İçermeyen Poliüretan İzolasyon
- * Dijital Kumanda Paneli
- * Otomatik Su Buharlaştırma Sistemi
- * Elektrikli Otomatik Defrost
- * Yüksekliği Ayarlanabilir Paslanmaz Ayaklar
- * Kapı Açıldığında Otomatik İç Aydınlatma
- * Özel, Kapı Menteşe Sistemi
- * Temizlenebilir ve Sökülebilir Manyetik Kapı Contası
- * Dış Ortam Sıcaklığı: + 43oC & % 65 Nem

Info

- * Inside Depth: 65 Cm (GN 2/1 Capacity)
- * 35-40 Kg/m³ Ecology Friendly HCFC Free Polyurethane Insulation
- * Digital Control Panel
- * Automatic Water Evaporation System
- * Electrical Automatic Defrost
- * Stainless Steel Legs Adjustable For Height
- * Automatic Lighting Inside When Door is Open
- * Special Door and Hinge Systems
- * Removable and Easy Cleaning Magnetic Gaskets
- * Ambient Temperature: + 43oC & % 65 Humidity

Model Models	İç Sıcaklık Temperature °C	Brüt Hacim Gross volume Lt.	Ölçüler Dimensions Cm.	Paket Ölçüsü Packing Dim. Cm.	Ağırlık Weight Kg.	Paslanmaz Özellikli Stainless Steel Type
 VN14-M-EF-R290	0/+8	1400	140x81x205	150x85x220	217	304
 VL14-M-EF-R290	-10/-22	1400	140x81x205	150x85x220	231	304
 BN14-M-EF-R290	0/+8	1400	140x81x205	150x85x220	217	430
 BL14-M-EF-R290	-10/-22	1400	140x81x205	150x85x220	231	430
 VN14-M-G-EF-R290	0/+8	1400	140x81x205	150x85x220	232	304
 VL14-M-G-EF-R290	-10/-22	1400	140x81x205	150x85x220	260	304
 BN14-M-G-EF-R290	0/+8	1400	140x81x205	150x85x220	232	430
 BL14-M-G-EF-R290	-10/-22	1400	140x81x205	150x85x220	260	430

İzolasyon Kalınlığı Insulation Thickness	Raf Adedi Shelf Unit	Soğutma Gazı Cooling Gas	Voltaj Voltage	Enerji Sınıfı Energy Rating	Kapı Adedi Door Unit	Model Models	Fiyat Price
60 mm	8	R290	220 V / 50 Hz	B	2	VN14-M-EF-R290	3.768 €
60 mm	8	R290	220 V / 50 Hz	D	2	VL14-M-EF-R290	4.655 €
60 mm	8	R290	220 V / 50 Hz	B	2	BN14-M-EF-R290	3.103 €
60 mm	8	R290	220 V / 50 Hz	D	2	BL14-M-EF-R290	3.949 €
60 mm	8	R290	220 V / 50 Hz	C	2	VN14-M-G-EF-R290	4.803 €
60 mm	8	R290	220 V / 50 Hz	E	2	VL14-M-G-EF-R290	6.207 €
60 mm	8	R290	220 V / 50 Hz	C	2	BN14-M-G-EF-R290	4.159 €
60 mm	8	R290	220 V / 50 Hz	E	2	BL14-M-G-EF-R290	5.427 €

Snack Dikey Buzdolapları 2 Kapılı

Snack Vertical Refrigerators 2 Doors



Option : 189 €

115 V / 60 Hz

58 Adet Raf Kapasitesi.
4,5 cm Aralıklı.
58 Unit Shelf Holder Capacity.
4,5 cm Spaced.

KF
Fanlı Kanopi
Canopy With Fan 89 €

VN12

FRENOX
PROFESSIONAL REFRIGERATION

Standard Line Series

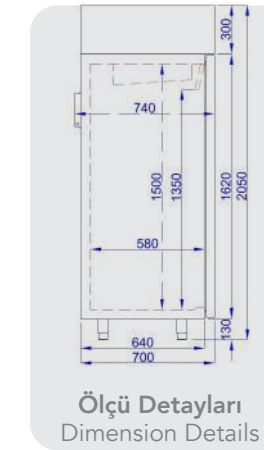

Ölçü Detayları
Dimension Details



Her Ürün İçin
10 Saatlik
Performans Testi
10 Hours
performance testing



Değiştirilebilir Arasında Kir
ve Bakteri Tutmayan Yüksek
Manyetik Çekimli ÖZEL
Conta
Special designed new gaskets.
Can be removed, dirt-free



Açılabilir Kanopiyle
Kolay Müdahale Olanığı
Front Cover Can be
Opened For Easy Access

Kod Özellikleri
Available Codes

Raf ve Raf Kızağı
Shelf and
Shelf
Holder 49 €

W
Tekerlekli / Wheels 90 €

T
Touch Dijital
Touch Digital 217 €

SE
Görüntü
Appearance 56 €

WP
Su Geçirmez Dijital
Water Proof Digital 137 €

-4
Yarım Kapı
Half Door 394 €

BT
Wi-Fi Dijital
Wi-Fi Digital 418 €

60hz
220 V
60 hz 56 €

LED
LED Aydınlatma
LED Lighting 85 €

Bilgi

- * 35-40 Kg/m³ Gazlı Çevre Dostu HCFC İçermeyen Poliüretan İzolasyon
- * Dijital Kumanda Paneli
- * Otomatik Su Buharlaştırma Sistemi
- * Otomatik Defrost
- * Yüksekliği Ayarlanabilir Paslanmaz Ayaklar
- * Kapı Açıldığında Otomatik İç Aydınlatma
- * Özel, Kapı Mentеше Sistemi
- * Temizlenebilir ve Sökülebilir Manyetik Kapı Contası
- * CFC Free Soğutma Gazı: R 134 A / R 404 A
- * Dış Ortam Sıcaklığı: + 43oC & % 65 Nem

Info

- * 35-40 Kg/m³ Ecology Friendly HCFC Free Polyurethane Insulation
- * Digital Control Panel
- * Automatic Water Evaporation System
- * Automatic Defrost
- * Stainless Steel Legs Adjustable For Height
- * Automatic Lighting Inside When Door is Open
- * Special Door and Hinge Systems
- * Removable and Easy Cleaning Magnetic Gaskets
- * Cooling Gas CFC Free: R 134 A / R 404 A
- * Ambient Temperature: + 43oC & % 65 Humidity

Model Models	İç Sıcaklık Temperature °C	Brüt Hacim Gross volume Lt.	Ölçüler Dimensions Cm.	Paket Ölçüsü Packing Dim. Cm.	Ağırlık Weight Kg.	Paslanmaz Özelliği Stainless Steel Type
	VN12	-2/+8	1200	140x70x205	150x80x220	304
	VL12	-10/-22	1200	140x70x205	150x80x220	304
	BN12	-2/+8	1200	140x70x205	150x80x220	430
	BL12	-10/-22	1200	140x70x205	150x80x220	430
	VN12-G	-2/+8	1200	140x70x205	150x80x220	304
	VL12-G	-10/-22	1200	140x70x205	150x80x220	304
	BN12-G	-2/+8	1200	140x70x205	150x80x220	430
	BL12-G	-10/-22	1200	140x70x205	150x80x220	430

İzolasyon Kalınlığı Insulation Thickness	Raf Adedi Shelf Unit	Soğutma Gazı Cooling Gas	Voltaj Voltage	Enerji Sınıfı Energy Rating	Kapı Adedi Door Unit	Fiyat Price €	Model Models	Fiyat Price
60 mm	6	R134A	220 V / 50 Hz	E	2	3.678 €	VN12-R290	3.650 €
60 mm	6	R404A	220 V / 50 Hz	E	2	4.505 €	VL12-R290	4.478 €
60 mm	6	R134A	220 V / 50 Hz	E	2	2.927 €	BN12-R290	2.901 €
60 mm	6	R404A	220 V / 50 Hz	E	2	3.794 €	BL12-R290	3.767 €
60 mm	6	R134A	220 V / 50 Hz	E	2	4.631 €	VN12-G-R290	4.603 €
60 mm	6	R404A	220 V / 50 Hz	E	2	6.042 €	VL12-G-R290	6.015 €
60 mm	6	R134A	220 V / 50 Hz	E	2	3.857 €	BN12-G-R290	3.830 €
60 mm	6	R404A	220 V / 50 Hz	E	2	5.265 €	BL12-G-R290	5.239 €

Dikey Buzdolapları Snack Serisi 1 Kapılı

Vertical Refrigerators Snack Series 1 Door



BN5-W

Option : 189 €

115 V / 60 Hz

42 Adet Raf
Kapasitesi.
2,5 cm Aralıklı.
42 Unit Shelf
Holder Capacity.
2,5 cm Spaced.

FRENOX
PROFESSIONAL REFRIGERATION

Standard Line Series

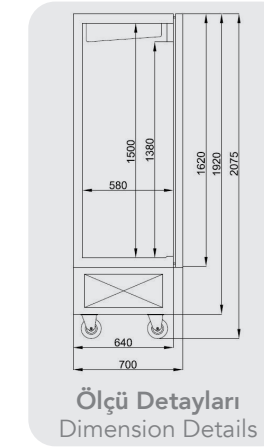

BL-5-W



BN-5-W

Bilgi

- * İç Derinlik: 58 Cm
- * 35-40 Kg/m³ Çevre Dostu HCFC İçermeyen Poliüretan İzolasyon
- * Dijital Kumanda Paneli
- * Kapıda Kilit
- * Otomatik Su Buharlaştırma Sistemi
- * Yüksekliği Ayarlanabilir Paslanmaz Ayaklar
- * Özel Kapı ve Menteşe Sistemi
- * Temizlenebilir ve Sökülebilir Manyetik Kapı Contası
- * Dış Ortam Sıcaklığı + 43°C & % 65 Nem

Info

- * Inside Depth: 58 Cm.
- * 35-40 Kg/m³ Ecology Friendly HCFC Polyurethane Insulation
- * Digital Control Panel
- * Door Lock
- * Automatic Water Evaporation System
- * Stainless Steel Legs Adjustable for Height
- * Special Door and Hinge Systems
- * Removable and Easy Cleaning Magnetic Gasket
- * Ambient Temperature + 43°C & % 65 Nem

Kod Özellikleri

Available Codes

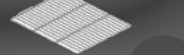
Raf
Shelf

45 €

W



Tekerlekli / Wheels

90 €

T

Touch Dijital
Touch Digital

217 €

WP

Su Geçirmez Dijital
Water Proof Digital

137 €

BT

Wi-Fi Dijital
Wi-Fi Digital

418 €

60_{hz}220 V
60 hz

56 €

Model Models	İç Sıcaklık Temperature °C	Brüt Hacim Gross volume Lt.	Ölçüler Dimensions Cm.	Paket Ölçüsü Packing Dim. Cm.	Ağırlık Weight Kg.	Paslanmaz Özelliği Stainless Steel Type
 BN5	-2/+8	550	70x70x208	80x80x225	133	430
BL5	-10/-20	550	70x70x208	80x80x225	140	430

İzolasyon Kalınlığı Insulation Thickness	Raf Adedi Shelf Unit	Soğutma Gazı Cooling Gas	Voltaj Voltage	Enerji Sınıfı Energy Rating	Kapı Adedi Door Unit	Fiyat Price €	Model Models	Fiyat Price
60 mm	3	R134A	220 V / 50 Hz	E	1	2.202 €	BN5-R290	2.176 €
60 mm	3	R404A	220 V / 50 Hz	E	1	2.801 €	BL5-R290	2.775 €

400 Litre Buzdolapları 1 Kapılı

400 Litre Refrigerators 1 Door



BN4

Option : 189 €

115 V / 60 Hz

20 Adet Raf Kapasitesi.
2,5 cm Aralıklı.
20 Unit Shelf Holder Capacity.
2,5 cm Spaced.

KF



89 €

Fanlı Kanopi
Canopy With Fan
FRENOX
PROFESSIONAL REFRIGERATION

Standard Line Series

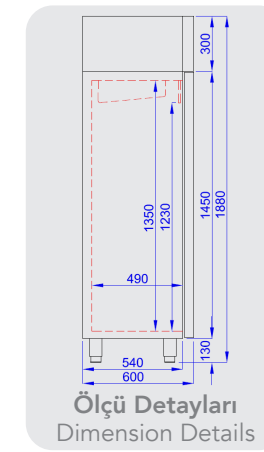
Ölçü Detayları
Dimension Details

BL4



BN4-G

Bilgi

- * 35-40 Kg/m³ Çevre Dostu HCFC İçermeyen Poliüretan İzolasyon
- * Fanlı Soğutma - Balık Dolabında Özel Balık Kurumasını Önleyen Soğutma Sistemi
- * Dijital Termometre & Termostat
- * Otomatik Defrost
- * Yüksekliği Ayarlanabilir Paslanmaz Ayaklar
- * Özel, Kapı Mentеше Sistemi
- * Temizlenebilir ve Sökülebilir Manyetik Kapı Contası
- * Plastik Kaplı Çelik Raf
- * Dış Ortam Sıcaklığı: + 32°C

Info

- * 35-40 Kg/m³ Ecology Friendly HCFC Free Polyurethane Insulation
- * Fan Cooling - Special Cooling System For Fish
- * Digital Thermometer & Thermostat
- * Automatic Defrost
- * Stainless Steel Legs Adjustable For Height
- * Special Door and Hinge Systems
- * Removable and Easy Cleaning Magnetic Gaskets
- * Plastic Coated Steel Shelf
- * Ambient Temperature: + 32°C

Kod Özellikleri
Available Codes

Raf Shelf 49 €

W Tekerlekli / Wheels 90 €

T Touch Dijital Touch Digital 217 €

WP Su Geçirmez Dijital Water Proof Digital 137 €



BT Wi-Fi Dijital Wi-Fi Digital 418 €

L Sol Kapı (Dikey) Left Door (Upright) 30 €

60_{hz} 220 V / 60 hz 56 €

REZ Su Buharlaşırma Rezistansı Water Evaporation Resistance 75 €

LED LED Aydınlatma LED Lighting 85 €

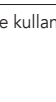
Model Models	İç Sıcaklık Temperature °C	Brüt Hacim Gross volume Lt.	Ölçüler Dimensions Cm.	Paket Ölçüsü Packing Dim. Cm.	Ağırlık Weight Kg.	Paslanmaz Özellizi Stainless Steel Type	
	BN4	-2/+8	400	60x60x188	70x70x210	100	430
	BL4	-10/-18	400	60x60x188	70x70x210	105	430
	BL4-G	-10/-18	400	60x60x188	70x70x210	110	430
	BN4-G	-2/+8	400	60x60x188	70x70x210	105	430
	BF4	0/-5	400	60x60x188	70x70x210	100	430

BF4 tepsi ile kullanıldığında kullanılabilir iç hacim, deklare edilen hacme göre azalacaktır. / If BF4 is used with Fish Tray accessories, the usable volume will be lower than declared.

İzolasyon Kalınlığı Insulation Thickness	Raf Adedi Shelf Unit	Soğutma Gazı Cooling Gas	Voltaj Voltage	Enerji Sınıfı Energy Rating	Kapı Adedi Door Unit	Fiyat Price €	Model Models	Fiyat Price
50 mm	3	R134A	220 V / 50 Hz	E	1	1.822 €	BN4-R290	1.795 €
50 mm	3	R404A	220 V / 50 Hz	E	1	2.139 €	BL4-R290	2.113 €
50 mm	3	R404A	220 V / 50 Hz	E	1	2.604 €	BL4-G-R290	2.577 €
50 mm	3	R134A	220 V / 50 Hz	E	1	2.181 €	BN4-G-R290	2.155 €
50 mm	3	R134A Static	220 V / 50 Hz	-	1	2.103 €	BF4-R290	2.077 €

Teşhir Buzdolapları 1 Kapılı

Display Refrigerators 1 Door



WN6-G

Option : 189€

115 V / 60 Hz

41 Adet Raf Kapasitesi.
2,5 cm Aralıklı.
41 Unit Shelf Holder Capacity.
2,5 cm Spaced.

Standart Üretim Tekerleklidir.

Standard Production is With Wheels.

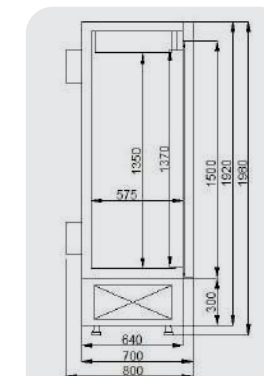

Standard Line Series

Ölçü Detayları
Dimension Details

SN6-G

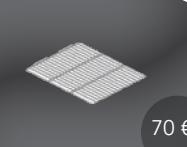
Kod Özellikleri
Available CodesRaf
Shelf

70 €

T

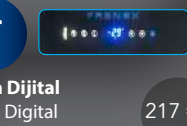
Touch Dijital
Touch Digital

217 €

BT

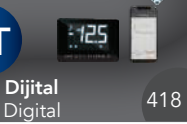
Wi-Fi Dijital
Wi-Fi Digital

418 €

60hz

220 V
60 hz

56 €

Bilgi

- * İç Gövde PVC Kaplı Galvaniz
- * Dış Gövde PVC Kaplı Galvaniz
- * İç Derinlik: 65 Cm
- * 35-40 Kg/m³ Gazlı Çevre Dostu HCFC İçermeyen Poliüretan İzolasyon
- * Dijital Kumanda Paneli
- * Otomatik Su Buharlaştırma Sistemi
- * İç Aydınlatma
- * Özel, Kapı Mentеше Sistemi
- * Temizlenebilir ve Sökülebilir Manyetik Kapı Contası
- * Dış Ortam Sıcaklığı: + 32°C % 40 Nem

Info

- * 60 mm Insulation Thickness
- * Inside Body PVC Coated Galvanize
- * Outside Body PVC Coated Galvanize
- * Inside Depth: 65 Cm
- * 35-40 Kg/m³ Ecology Friendly HCFC Free Polyurethane Insulation
- * Digital Control Panel
- * Automatic Water Evaporation System
- * Lighting Inside
- * Special Door and Hinge Systems
- * Removable and Easy Cleaning Magnetic Gaskets
- * Ambient Temperature: + 32°C & % 40 Humidity

Model Models	İç Sıcaklık Temperature °C	Brüt Hacim Gross volume Lt.	Ölçüler Dimensions Cm.	Paket Ölçüsü Packing Dim. Cm.	Ağırlık Weight Kg.	Paslanmaz Özelligi Stainless Steel Type	
	WN6-G	-2/+8	650	70x80x198	85x85x220	170	BEYAZ WHITE
	WL6-G	-2/-18	650	70x80x198	85x85x220	175	BEYAZ WHITE
	SN6-G	-2/+8	650	70x80x198	85x85x220	170	430
	SL6-G	-2/-18	650	70x80x198	85x85x220	175	430

İzolasyon Kalınlığı Insulation Thickness	Raf Adedi Shelf Unit	Soğutma Gazı Cooling Gas	Voltaj Voltage	Kapı Adedi Door Unit	Fiyat Price €	Model Models	Fiyat Price
60 mm	6	R134A	220 V / 50 Hz	1	3.802 €	WN6-G-R290	3.769 €
60 mm	6	R404A	220 V / 50 Hz	1	4.161 €	WL6-G-R290	4.127 €
60 mm	6	R134A	220 V / 50 Hz	1	3.594 €	SN6-G-R290	3.563 €
60 mm	6	R404A	220 V / 50 Hz	1	4.161 €	SL6-G-R290	4.131 €

Teşhir Buzdolapları 2 Kapılı

Display Refrigerators 2 Doors



WL13-G

Option : 189 €



115 V / 60 Hz

82 Adet Raf Kapasitesi.
2,5 cm Aralıklı.
82 Unit Shelf Holder Capacity.
2,5 cm Spaced.

Standart Üretim Tekerleklidir.
Standard Production is With Wheels.

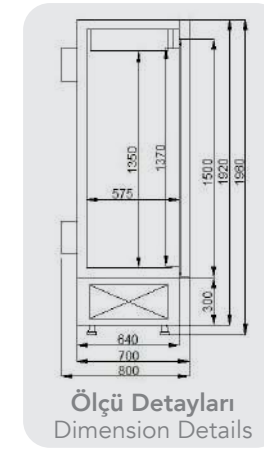

Standard Line Series

Ölçü Detayları
Dimension Details

WN13-G

Bilgi

- * İç Gövde PVC Kaplı Galvaniz
- * Dış Gövde PVC Kaplı Galvaniz
- * İç Derinlik: 65 Cm
- * 35-40 Kg/m³ Gazlı Çevre Dostu HCFC İçermeyen Poliüretan İzolasyon
- * Dijital Kumanda Paneli
- * Otomatik Su Buharlaştırma Sistemi
- * İç Aydınlatma
- * Özel, Kapı Mentеше Sistemi
- * Temizlenebilir ve Sökülebilir Manyetik Kapı Contası
- * Dış Ortam Sıcaklığı: + 32°C % 40 Nem

Info

- * 60 mm Insulation Thickness
- * Inside Body PVC Coated Galvanize
- * Outside Body PVC Coated Galvanize
- * Inside Depth: 65 Cm
- * 35-40 Kg/m³ Ecology Friendly HCFC Free Polyurethane Insulation
- * Digital Control Panel
- * Automatic Water Evaporation System
- * Lighting Inside
- * Special Door and Hinge Systems
- * Removable and Easy Cleaning Magnetic Gaskets
- * Ambient Temperature: + 32°C & % 40 Humidity

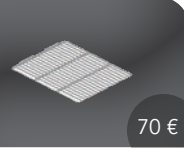
Kod Özellikleri
Available CodesRaf
Shelf

70 €

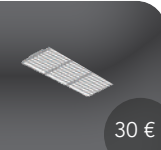
Ara Raf
Middle
Shelf

30 €

T

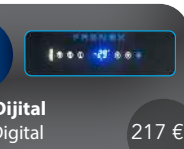
Touch Dijital
Touch Digital

217 €

BT

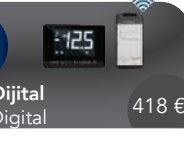
Wi-Fi Dijital
Wi-Fi Digital

418 €

60hz

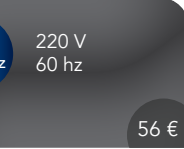
220 V
60 hz

56 €

Model Models	İç Sıcaklık Temperature °C	Brüt Hacim Gross volume Lt.	Ölçüler Dimensions Cm.	Paket Ölçüsü Packing Dim. Cm.	Ağırlık Weight Kg.	Paslanmaz Özelliği Stainless Steel Type	
	WN13-G	-2/+8	1300	140x80x198	150x90x220	289	BEYAZ / WHITE
	WL13-G	-2/-18	1300	140x80x198	150x90x220	296	BEYAZ / WHITE
	SN13-G	-2/+8	1300	140x80x198	150x90x220	289	430
	SL13-G	-2/-18	1300	140x80x198	150x90x220	296	430

İzolasyon Kalınlığı Insulation Thickness	Raf Adedi Shelf Unit	Soğutma Gazı Cooling Gas	Voltaj Voltage	Kapı Adedi Door Unit	Fiyat Price €	Model Models	Fiyat Price
60 mm	12	R134A	220 V / 50 Hz	2	5.821 €	WN13-G-R290	5.786 €
60 mm	12	R404A	220 V / 50 Hz	2	6.192 €	WL13-G-R290	6.158 €
60 mm	12	R134A	220 V / 50 Hz	2	6.352 €	SN13-G-R290	6.317 €
60 mm	12	R404A	220 V / 50 Hz	2	6.901 €	SL13-G-R290	6.868 €

Yatay Buzdolapları 1 Kapılı

Counter Type Refrigerators 1 Door

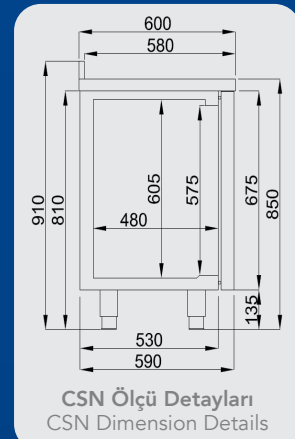

CSN Ölçü Detayları
CSN Dimension Details

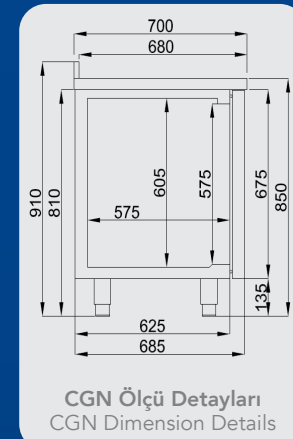

CGN Ölçü Detayları
CGN Dimension Details

Option : 189 €

115 V / 60 Hz



CGN1-C

KF



153€

Fanlı Kanopi
Canopy With Fan

Standart Sirt Yüksekliği 6
cm'dir.

Standart Splash Back
Height is 6 cm

Derin Dondurucularda Kanopide Fan Mevcuttur.
Deep Freezers Have Fan On The Canopy



FRENOX
PROFESSIONAL REFRIGERATION

Standard Line Series

Çekmece Seçenekleri / Drawer Options

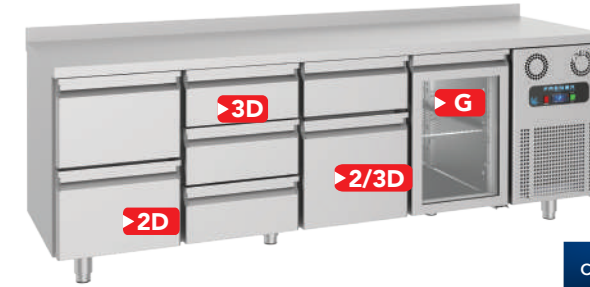

3D 1/3 Çekmece - 1/3 Drawers 597 €

2D 1/2 Çekmece - 1/2 Drawers 469 €

G Cam Kapı - Glass Door 228 €

2/3D 2/3 Çekmece - 2/3 Drawers 564 €

Cam Kapı Sadece Pozitif Kapılar İçindir
Glass Door Option is Only Available for Positive Doors

Bilgi

- * İç Derinlik: 43 Cm / 53 Cm (GN 1/1 Kapasiteli)
- * 35-40 Kg/m³ Çevre Dostu HCFC İçermeyen Poliüretan İzolasyon
- * Dijital Kumanda Paneli
- * Elektrik Rezistanslı Otomatik Defrost
- * Özel Su Buharlaştırma Sistemi
- * Yüksekliği Ayarlanabilir Paslanmaz Ayaklar
- * Özel, Kapı Mentеше Sistemi
- * Temizlenebilir ve Sökülebilir Manyetik Kapı Contası
- * CFC Free Soğutma Gazı: R 134 A / R 404 A
- * Dış Ortam Sıcaklığı: + 43oC & % 65 Nem

Info

- * Inside Depth: 43 Cm / 53 Cm (GN 1/1 Capacity)
- * 35-40 Kg/m³ Ecology Friendly HCFC Free Polyurethane Insulation
- * Digital Control Panel
- * Electrical Resistor Automatic Defrost
- * Special Water Evaporation
- * Stainless Steel Legs Adjustable For Height
- * Special Door and Hinge Systems
- * Removable and Easy Cleaning Magnetic Gaskets
- * Cooling Gas CFC Free: R 134 A / R 404 A
- * Ambient Temperature: + 43oC %65 Humidity

Kod Özellikleri

Available Codes

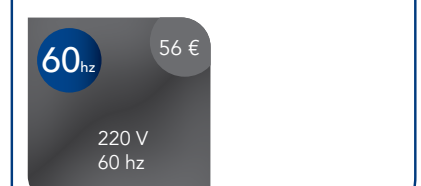

Model Models	İç Sıcaklık Temperature °C	Brüt Hacim Gross volume Lt.	Ölçüler Dimensions Cm.	Paket Ölçüsü Packing Dim. Cm.	Ağırlık Weight Kg.	Paslanmaz Özellikli Stainless Steel Type
	CSN1-C	-2/+8	125	93,5x60x85	100x70x100	60 304
	CGN1-C	-2/+8	140	93,5x70x85	100x80x100	65 304
	CSL1-C	-10/-20	125	93,5x60x85	100x70x100	65 304
	BGN1-C	-2/+8	140	93,5x70x85	100x80x100	65 430
	BSL1-C	-10/-20	125	93,5x60x85	100x70x100	65 430
	BGL1-C	-10/-20	140	93,5x70x85	100x80x100	70 430
	CGN1-G-C	-2/+8	140	93,5x70x85	100x80x100	68 304
	BSN1-G-C	-2/+8	125	93,5x60x85	100x70x100	63 430
	BGN1-G-C	-2/+8	140	93,5 x70x85	100x80x100	68 430

İzolasyon Kalınlığı Insulation Thickness	Raf Adedi Shelf Unit	Soğutma Gazı Cooling Gas	Voltaj Voltage	Enerji Sınıfı Energy Rating	Fiyat Price €	Model Models	Fiyat Price
50 mm	1	R134A	220 V - 50 Hz	E	2.387 €	CSN1-C-R290	2.359 €
50 mm	1	R134A	220 V - 50 Hz	E	2.485 €	CGN1-C-R290	2.457 €
50 mm	1	R404A	220 V - 50 Hz	E	3.009 €	CSL1-C-R290	2.982 €
50 mm	1	R404A	220 V - 50 Hz	E	3.087 €	CGL1-C-R290	3.059 €
50 mm	1	R134A	220 V - 50 Hz	E	1.885 €	BSN1-C-R290	1.859 €
50 mm	1	R134A	220 V - 50 Hz	E	1.984 €	BGN1-C-R290	1.957 €
50 mm	1	R404A	220 V - 50 Hz	E	2.421 €	BSL1-C-R290	2.394 €
50 mm	1	R404A	220 V - 50 Hz	E	2.519 €	BGL1-C-R290	2.493 €
50 mm	1	R134A	220 V - 50 Hz	E	2.608 €	CSN1-G-C-R290	2.580 €
50 mm	1	R134A	220 V - 50 Hz	E	2.707 €	CGN1-G-C-R290	2.679 €
50 mm	1	R134A	220 V - 50 Hz	E	2.097 €	BSN1-G-C-R290	2.071 €
50 mm	1	R134A	220 V - 50 Hz	E	2.196 €	BGN1-G-C-R290	2.169 €

Yatay Buzdolapları 2 Kapılı

Counter Type Refrigerators 2 Door

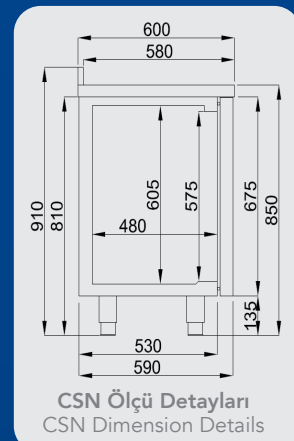
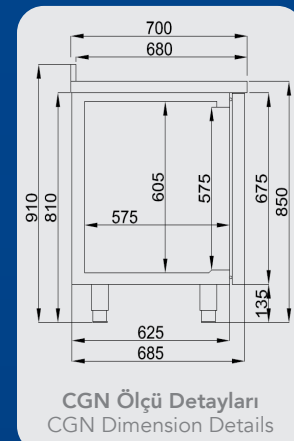
CSN Ölçü Detayları
CSN Dimension DetailsCGN Ölçü Detayları
CGN Dimension Details

Option : 189 €

115 V / 60 Hz



CGN2

KF



153€

Fanlı Kanopi
Canopy With FanStandart Sırt Yüksekliği 6
cm'dir.Standart Splash Back
Height is 6 cmDerin Dondurucularda Kanopide Fan Mevcuttur.
Deep Freezers Have Fan On The CanopyFRENEX
PROFESSIONAL REFRIGERATION

Standard Line Series

Çekmece Seçenekleri / Drawer Options

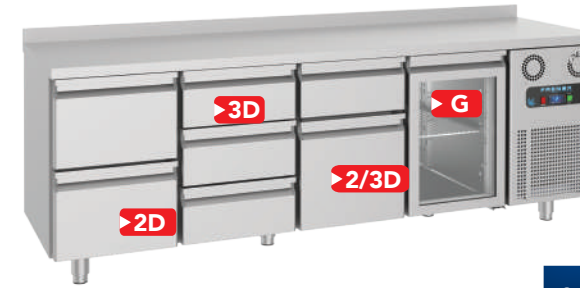

3D 1/3 Çekmece - 1/3 Drawers 597 €

2D 1/2 Çekmece - 1/2 Drawers 469 €

G Cam Kapı - Glass Door 228 €

2/3D 2/3 Çekmece - 2/3 Drawers 564 €

Cam Kapı Sadece Pozitif Kapılar İçindir
Glass Door Option is Only Available for Positive Doors

Bilgi

- * İç Derinlik: 43 Cm / 53 Cm (GN 1/1 Kapasiteli)
- * 35-40 Kg/m³ Çevre Dostu HCFC İçermeyen Poliüretan İzolasyon
- * Dijital Kumanda Paneli
- * Elektrik Rezistanslı Otomatik Defrost
- * Özel Su Buharlaştırma Sistemi
- * Yüksekliği Ayarlanabilir Paslanmaz Ayaklar
- * Özel, Kapı Mentеше Sistemi
- * Temizlenebilir ve Sökülebilir Manyetik Kapı Contası
- * Dış Ortam Sıcaklığı: + 43°C & % 65 Nem

Info

- * Inside Depth: 43 Cm / 53 Cm (GN 1/1 Capacity)
- * 35-40 Kg/m³ Ecology Friendly HCFC Free Polyurethane Insulation
- * Digital Control Panel
- * Electrical Resistor Automatic Defrost
- * Special Water Evaporation
- * Stainless Steel Legs Adjustable For Height
- * Special Door and Hinge Systems
- * Removable and Easy Cleaning Magnetic Gaskets
- * Ambient Temperature: + 43°C %65 Humidity

Kod Özellikleri
Available Codes

Raf ve Raf Kızağı Shelf and Shelf Holder	49 €	A	70 €
10 cm Yuvarlatılmış Sırtlı Tabla 10 cm Curved Splashback Work Top			
DZ	0 €		370 €
Düz Üst Tabla Straight Work Top			
Mermer Üst Tabla Marble Work Top			
GR	745 €	MR	304 : -135 € 430 : -80 €
Granit Üst Tabla Granite Work Top			
Üst Tablasız Without Work Top			
PL	709 €	F	217 €
Poliyeten Üst Tabla Polyethylene Work Top			
Touch Dijital Touch Digital			
DKP	30 €	RD	45 €
Dijital Koruma Plastiği Digital Cover			
Yuvarlatılmış Tabla Curved Work Top			
WP	137 €	W	90 €
Su Geçirmez Dijital Water Proof Digital			
Tekerlekli Wheels			
BT	418 €	60 _{hz}	56 €
Wi-Fi Dijital Wi-Fi Digital			
220 V 60 hz			
K	70 €/Unt		
Kilitli Kapı With Lock			
L	30 €		
Sol Motor (Dikey) Left Motor (Upright)			

Model Models	İç Sıcaklık Temperature °C	Brüt Hacim Gross volume Lt.	Ölçüler Dimensions Cm.	Paket Ölçüsü Packing Dim. Cm.	Ağırlık Weight Kg.	Paslanmaz Özellikli Stainless Steel Type	
	CSN2	-2/+8	250	140x60x85	150x70x100	130	304
	CGN2	-2/+8	281	140x70x85	150x80x100	136	304
	CSL2	-10/-20	250	140x60x85	150x70x100	140	304
	CGL2	-10/-20	281	140x70x85	150x80x100	145	304
	BSN2	-2/+8	250	140x60x85	150x70x100	130	430
	BGN2	-2/+8	281	140x70x85	150x80x100	136	430
	BSL2	-10/-20	250	140x60x85	150x70x100	140	430
	BGL2	-10/-20	281	140x70x85	150x80x100	145	430
	CSN2-G	-2/+8	250	140x60x85	150x70x100	135	304
	CGN2-G	-2/+8	281	140x70x85	150x80x100	141	304
	BSN2-G	-2/+8	250	140x60x85	150x70x100	135	430
	BGN2-G	-2/+8	281	140x70x85	150x80x100	141	430

İzolasyon Kalınlığı Insulation Thickness	Raf Adedi Shelf Unit	Soğutma Gazı Cooling Gas	Voltaj Voltage	Enerji Sınıfı Energy Rating	Fiyat Price €	Model Models	Fiyat Price
50 mm	2	R134A	220 V / 50 Hz	E	2.489 €	CSN2-R290	2.461 €
50 mm	2	R134A	220 V / 50 Hz	E	2.584 €	CGN2-R290	2.556 €
50 mm	2	R404A	220 V / 50 Hz	E	3.170 €	CSL2-R290	3.142 €
50 mm	2	R404A	220 V / 50 Hz	E	3.353 €	CGL2-R290	3.326 €
50 mm	2	R134A	220 V / 50 Hz	E	1.984 €	BSN2-R290	1.957 €
50 mm	2	R134A	220 V / 50 Hz	E	2.013 €	BGN2-R290	1.986 €
50 mm	2	R404A	220 V / 50 Hz	E	2.547 €	BSL2-R290	2.521 €
50 mm	2	R404A	220 V / 50 Hz	E	2.648 €	BGL2-R290	2.622 €
50 mm	2	R134A	220 V / 50 Hz	E	2.932 €	CSN2-G-R290	2.904 €
50 mm	2	R134A	220 V / 50 Hz	E	3.027 €	CGN2-G-R290	3.000 €
50 mm	2	R134A	220 V / 50 Hz	E	2.406 €	BSN2-G-R290	2.380 €
50 mm	2	R134A	220 V / 50 Hz	E	2.435 €	BGN2-G-R290	2.409 €

Yatay Buzdolapları 2 Kapılı - EF Serisi

Counter Type Refrigerators 2 Door - EF Series

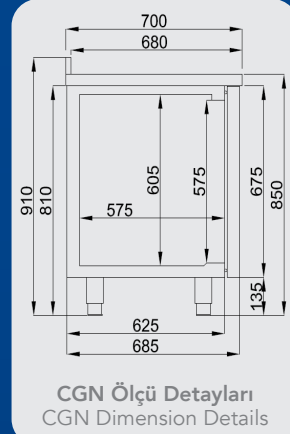
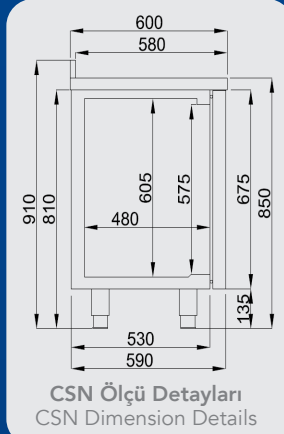

CGN2-EF-R290



R290

Option : 189 €

115 V / 60 Hz

KF

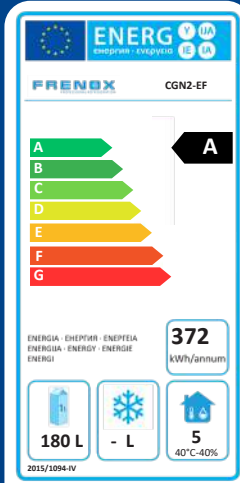

153€

Fanlı Kanopi
Canopy With FanStandart Sırt Yüksekliği 6
cm'dir.Standart Splash Back
Height is 6 cmDerin Dondurucularda Kanopide Fan Mevcuttur.
Deep Freezers Have Fan On The CanopyElektrik Testi
EN ISO 22041:2019
Standartlarında yapılmıştır.Electricity Consumption
Test is Hold Under EN ISO
22041:2019 Standard.

Standard Line Series

Çekmece Seçenekleri / Drawer Options

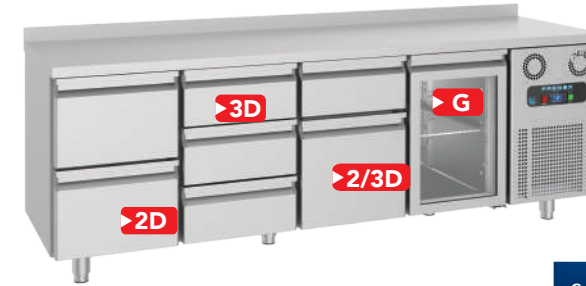

- 3D 1/3 Çekmece - 1/3 Drawers 597 €
- 2D 1/2 Çekmece - 1/2 Drawers 469 €
- G Cam Kapı - Glass Door 228 €
- 2/3D 2/3 Çekmece - 2/3 Drawers 564 €

Cam Kapı Sadece Pozitif Kapılar İçindir
Glass Door Option is Only Available for Positive Doors

Bilgi

- * İç Derinlik: 43 Cm / 53 Cm (GN 1/1 Kapasiteli)
- * 35-40 Kg/m³ Çevre Dostu HCFC İçermeyen Poliüretan İzolasyon
- * Dijital Kumanda Paneli
- * Elektrik Rezistanslı Otomatik Defrost
- * Özel Su Buharlaştırma Sistemi
- * Yüksekliği Ayarlanabilir Paslanmaz Ayaklar
- * Özel, Kapı Mentеше Sistemi
- * Temizlenebilir ve Sökülebilir Manyetik Kapı Contası
- * Dış Ortam Sıcaklığı: + 43°C & % 65 Nem

Info

- * Inside Depth: 43 Cm / 53 Cm (GN 1/1 Capacity)
- * 35-40 Kg/m³ Ecology Friendly HCFC Free Polyurethane Insulation
- * Digital Control Panel
- * Electrical Resistor Automatic Defrost
- * Special Water Evaporation
- * Stainless Steel Legs Adjustable For Height
- * Special Door and Hinge Systems
- * Removable and Easy Cleaning Magnetic Gaskets
- * Ambient Temperature: + 43°C %65 Humidity

Kod Özellikleri
Available Codes

Raf ve Raf Kızağı Shelf and Shelf Holder 49 €	A 70 €
DZ 0 €	MR 370 €
Düz Üst Tabla Straight Work Top	Mermer Üst Tabla Marble Work Top
GR 745 €	F 304 : -135 € 430 : -80 €
Granit Üst Tabla Granite Work Top	Üst Tablasız Without Work Top
PL 709 €	T 217 €
Poliyeten Üst Tabla Polyethylene Work Top	Touch Dijital Touch Digital
DKP 30 €	RD 45 €
Dijital Koruma Plastiği Digital Cover	Yuvarlatılmış Tabla Curved Work Top
WP 137 €	W 90 €
Su Geçirmez Dijital Water Proof Digital	Tekerlekli Wheels
BT 418 €	60hz 56 €
Wi-Fi Dijital Wi-Fi Digital	220 V 60 Hz
K 70 €/Unt	Kilitli Kapı With Lock
L 30 €	Sol Motor (Dikey) Left Motor (Upright)

Model Models	İç Sıcaklık Temperature °C	Brüt Hacim Gross volume Lt.	Ölçüler Dimensions Cm.	Paket Ölçüsü Packing Dim. Cm.	Ağırlık Weight Kg.	Paslanmaz Özellikli Stainless Steel Type
CSN2 -EF-R290	-2/+8	250	140x60x85	150x70x100	130	304
CGN2 -EF-R290	-2/+8	281	140x70x85	150x80x100	136	304
BSN2 -EF-R290	-2/+8	250	140x60x85	150x70x100	130	430
BGN2 -EF-R290	-2/+8	281	140x70x85	150x80x100	136	430
CSN2-G -EF-R290	-2/+8	250	140x60x85	150x70x100	135	304
CGN2-G -EF-R290	-2/+8	281	140x70x85	150x80x100	141	304
BSN2-G -EF-R290	-2/+8	250	140x60x85	150x70x100	135	430
BGN2-G -EF-R290	-2/+8	281	140x70x85	150x80x100	141	430

İzolasyon Kalınlığı Insulation Thickness	Raf Adedi Shelf Unit	Soğutma Gazı Cooling Gas	Voltaj Voltage	Enerji Sınıfı Energy Rating	Model Models	Fiyat Price
50 mm	2	R290	220 V / 50 Hz	A	CSN2 -EF-R290	2.536 €
50 mm	2	R290	220 V / 50 Hz	A	CGN2 -EF-R290	2.631 €
50 mm	2	R290	220 V / 50 Hz	A	BSN2 -EF-R290	2.032 €
50 mm	2	R290	220 V / 50 Hz	A	BGN2 -EF-R290	2.060 €
50 mm	2	R290	220 V / 50 Hz	B	CSN2-G -EF-R290	2.979 €
50 mm	2	R290	220 V / 50 Hz	B	CGN2-G -EF-R290	3.074 €
50 mm	2	R290	220 V / 50 Hz	B	BSN2-G -EF-R290	2.454 €
50 mm	2	R290	220 V / 50 Hz	B	BGN2-G -EF-R290	2.484 €

EF: Bu modellerde energy efficiency kondenser fanı kullanılmaktadır. / These models have energy efficiency condenser fans.

Yatay Buzdolapları 3 Kapılı

Counter Type Refrigerators 3 Door

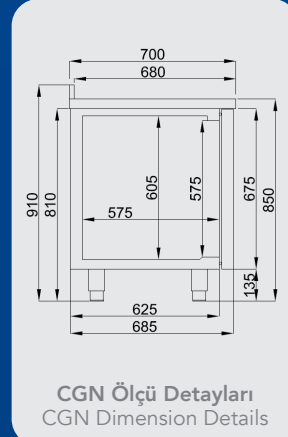
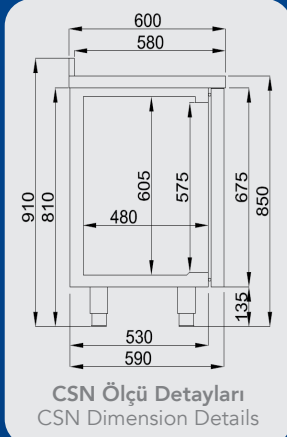

Option : 189 €

115 V / 60 Hz



Standart Sırt Yüksekliği 6 cm'dir.

Standart Splash Back Height is 6 cm



CGN3

Derin Dondurucularda Kanopide Fan Mevcuttur.
Deep Freezers Have Fan On The Canopy

Model Models	İç Sıcaklık Temperature °C	Brüt Hacim Gross volume Lt.	Ölçüler Dimensions Cm.	Paket Ölçüsü Packing Dim. Cm.	Ağırlık Weight Kg.	Paslanmaz Özelliği Stainless Steel Type
	CSN3	-2/+8	400	186,5x60x85	197x70x100	304
	CGN3	-2/+8	474	186,5x70x85	197x80x100	304
	CSL3	-10/-20	400	186,5x60x85	197x70x100	304
	CGL3	-10/-20	474	186,5x70x85	197x80x100	304
	BSN3	-2/+8	400	186,5x60x85	197x70x100	430
	BGN3	-2/+8	474	186,5x70x85	197x80x100	430
	BSL3	-10/-20	400	186,5x60x85	197x70x100	430
	BGL3	-10/-20	474	186,5x70x85	197x80x100	430
	CSN3-G	-2/+8	400	186,5x60x85	197x70x100	304
	CGN3-G	-2/+8	474	186,5x70x85	197x80x100	304
	BSN3-G	-2/+8	400	186,5x60x85	197x70x100	430
	BGN3-G	-2/+8	474	186,5x70x85	197x80x100	430



FRENOX
PROFESSIONAL REFRIGERATION

Standard Line Series

Çekmece Seçenekleri / Drawer Options

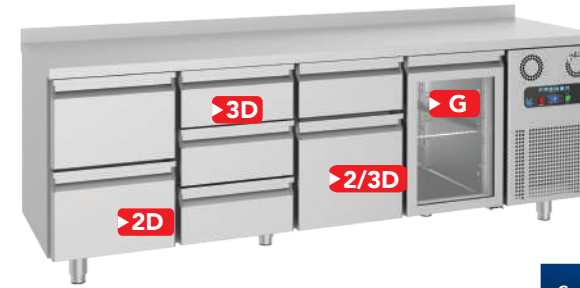

- 3D** 1/3 Çekmece - 1/3 Drawers 597 €
- 2D** 1/2 Çekmece - 1/2 Drawers 469 €
- G** Cam Kapı - Glass Door 228 €
- 2/3D** 2/3 Çekmece - 2/3 Drawers 564 €

Cam Kapı Sadece Pozitif Kapılar İçindir
Glass Door Option is Only Available for Positive Doors

Bilgi

- * İç Derinlik: 43 Cm / 53 Cm (GN 1/1 Kapasiteli)
- * 35-40 Kg/m³ Çevre Dostu HCFC İçermeyen Poliüretan İzolasyon
- * Dijital Kumanda Paneli
- * Elektrik Rezistanslı Otomatik Defrost
- * Özel Su Buharlaştırma Sistemi
- * Yüksekliği Ayarlanabilir Paslanmaz Ayaklar
- * Özel, Kapı Mentеше Sistemi
- * Temizlenebilir ve Sökülebilir Manyetik Kapı Contası
- * Dış Ortam Sıcaklığı: + 43°C & % 65 Nem

Info

- * Inside Depth: 43 Cm / 53 Cm (GN 1/1 Capacity)
- * 35-40 Kg/m³ Ecology Friendly HCFC Free Polyurethane Insulation
- * Digital Control Panel
- * Electrical Resistor Automatic Defrost
- * Special Water Evaporation
- * Stainless Steel Legs Adjustable For Height
- * Special Door and Hinge Systems
- * Removable and Easy Cleaning Magnetic Gaskets
- * Ambient Temperature: + 43°C %65 Humidity

Kod Özellikleri Available Codes

Raf ve Raf Kızağı Shelf and Shelf Holder 49 €	A 70 € 10 cm Yuvarlatılmış Sırtlı Tabla 10 cm Curved Splashback Work Top
DZ 0 € Düz Üst Tabla Straight Work Top	MR 481 € Mermer Üst Tabla Marble Work Top
GR 960 € Granit Üst Tabla Granite Work Top	F 304 : -174 € 430 : -88 € Üst Tablasız Without Work Top
PL 932 € Polietilen Üst Tabla Polyethylene Work Top	T 217 € Touch Dijital Touch Digital
DKP 30 € Dijital Koruma Plastiği Digital Cover	RD 45 € Yuvarlatılmış Tabla Curved Work Top
WP 137 € Su Geçirmez Dijital Water Proof Digital	W 90 € Tekerlekli Wheels
BT 418 € Wi-Fi Dijital Wi-Fi Digital	60hz 56 € 220 V 60 Hz
K 70 €/Unt Kilitli Kapı With Lock	
L 30 € Sol Motor (Dikey) Left Motor (Upright)	

Yatay Buzdolapları 3 Kapılı - EF Serisi

Counter Type Refrigerators 3 Door - EF Series

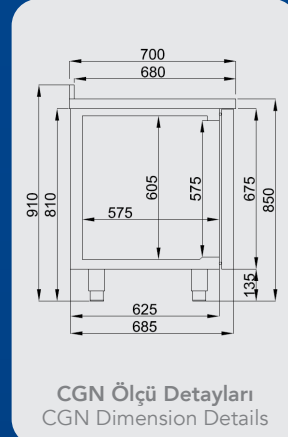
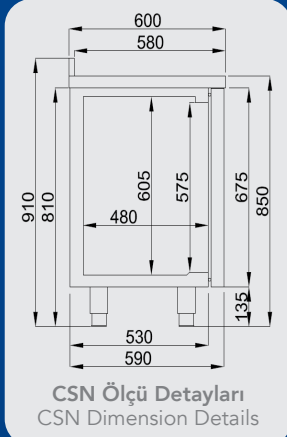

R290

Option : 189 €

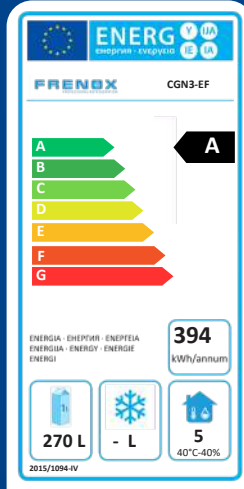

Elektrik Testi
EN ISO 22041:2019
Standartlarında yapılmıştır.

Electricity Consumption
Test is Hold Under EN ISO
22041:2019 Standard.

115 V / 60 Hz

KF



Standart Sırt Yüksekliği 6
cm'dir.

Standart Splash Back
Height is 6 cm

Derin Dondurucularda Kanopide Fan Mevcuttur.
Deep Freezers Have Fan On The Canopy



CGN3-EF-R290



FRENEX
PROFESSIONAL REFRIGERATION

Standard Line Series

Çekmece Seçenekleri / Drawer Options

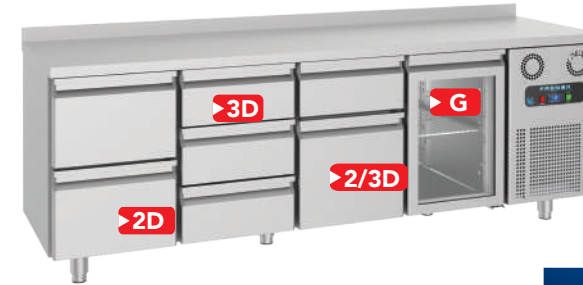

- 3D** 1/3 Çekmece - 1/3 Drawers 597 €
- 2D** 1/2 Çekmece - 1/2 Drawers 469 €
- G** Cam Kapı - Glass Door 228 €
- 2/3D** 2/3 Çekmece - 2/3 Drawers 564 €

Cam Kapı Sadece Pozitif Kapılar İçindir
Glass Door Option is Only Available for Positive Doors

Bilgi

- * İç Derinlik: 43 Cm / 53 Cm (GN 1/1 Kapasiteli)
- * 35-40 Kg/m³ Çevre Dostu HCFC İçermeyen Poliüretan İzolasyon
- * Dijital Kumanda Paneli
- * Elektrik Rezistanslı Otomatik Defrost
- * Özel Su Buharlaştırma Sistemi
- * Yüksekliği Ayarlanabilir Paslanmaz Ayaklar
- * Özel, Kapı Mentеше Sistemi
- * Temizlenebilir ve Sökülebilir Manyetik Kapı Contası
- * Dış Ortam Sıcaklığı: + 43°C & % 65 Nem

Info

- * Inside Depth: 43 Cm / 53 Cm (GN 1/1 Capacity)
- * 35-40 Kg/m³ Ecology Friendly HCFC Free Polyurethane Insulation
- * Digital Control Panel
- * Electrical Resistor Automatic Defrost
- * Special Water Evaporation
- * Stainless Steel Legs Adjustable For Height
- * Special Door and Hinge Systems
- * Removable and Easy Cleaning Magnetic Gaskets
- * Ambient Temperature: + 43°C %65 Humidity

Kod Özellikleri

Available Codes

Raf ve Raf Kızağı Shelf and Shelf Holder	49 €	A	70 €
Düz Üst Tabla Straight Work Top	0 €	MR	481 €
GR	960 €	F	304 : -174 € 430 : -88 €
PL	932 €	T	217 €
DKP	30 €	RD	45 €
WP	137 €	W	90 €
BT	418 €	60hz	56 €
K	70 €/Unt		
L	30 €		

Model Models	İç Sıcaklık Temperature °C	Brüt Hacim Gross volume Lt.	Ölçüler Dimensions Cm.	Paket Ölçüsü Packing Dim. Cm.	Ağırlık Weight Kg.	Paslanmaz Özellikli Stainless Steel Type
 CSN3-EF-R290	-2/+8	400	186,5x60x85	197x70x100	168	304
 CGN3-EF-R290	-2/+8	474	186,5x70x85	197x80x100	175	304
 BSN3-EF-R290	-2/+8	400	186,5x60x85	197x70x100	168	430
BGN3-EF-R290	-2/+8	474	186,5x70x85	197x80x100	175	430
CSN3-G-EF-R290	-2/+8	400	186,5x60x85	197x70x100	175	304
CGN3-G-EF-R290	-2/+8	474	186,5x70x85	197x80x100	183	304
BSN3-G-EF-R290	-2/+8	400	186,5x60x85	197x70x100	175	430
BGN3-G-EF-R290	-2/+8	474	186,5x70x85	197x80x100	183	430

İzolasyon Kalınlığı Insulation Thickness	Raf Adedi Shelf Unit	Soğutma Gazı Cooling Gas	Voltaj Voltage	Enerji Sınıfı Energy Rating	Model Models	Fiyat Price
50 mm	3	R290	220 V / 50 Hz	A	CSN3-EF-R290	3.014 €
50 mm	3	R290	220 V / 50 Hz	A	CGN3-EF-R290	3.080 €
50 mm	3	R290	220 V / 50 Hz	A	BSN3-EF-R290	2.491 €
50 mm	3	R290	220 V / 50 Hz	A	BGN3-EF-R290	2.491 €
50 mm	3	R290	220 V / 50 Hz	B	CSN3-G-EF-R290	3.679 €
50 mm	3	R290	220 V / 50 Hz	B	CGN3-G-EF-R290	3.746 €
50 mm	3	R290	220 V / 50 Hz	B	BSN3-G-EF-R290	2.983 €
50 mm	3	R290	220 V / 50 Hz	B	BGN3-G-EF-R290	3.081 €

EF: Bu modellerde energy efficiency kondenser fanı kullanılmaktadır. / These models have energy efficiency condenser fans.

Yatay Buzdolapları 4 Kapılı

Counter Type Refrigerators 4 Door

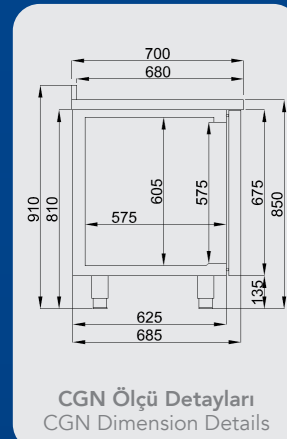
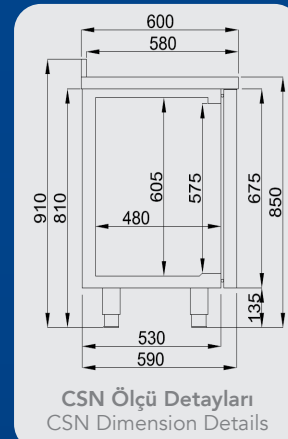

Option : 189 €

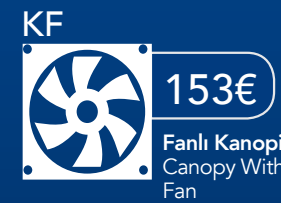

Standart Sirt Yüksekliği 6 cm'dir.

Standart Splash Back Height is 6 cm



CGN4

Derin Dondurucularda Kanopide Fan Mevcuttur.
Deep Freezers Have Fan On The Canopy

Model Models	İç Sıcaklık Temperature °C	Brüt Hacim Gross volume Lt.	Ölçüler Dimensions Cm.	Paket Ölçüsü Packing Dim. Cm.	Ağırlık Weight Kg.	Paslanmaz Özelliği Stainless Steel Type
	CSN4	-2/+8	550	233x60x85	243x70x100	304
	CGN4	-2/+8	632	233x70x85	243x80x100	304
	CSL4	-10/-20	550	233x60x85	243x70x100	304
	CGL4	-10/-20	632	233x70x85	243x80x100	304
	BSN4	-2/+8	550	233x60x85	243x70x100	430
	BGN4	-2/+8	632	233x70x85	243x80x100	430
	BSL4	-10/-20	550	233x60x85	243x70x100	430
	BGL4	-10/-20	632	233x70x85	243x80x100	430
	CSN4-G	-2/+8	550	233x60x85	243x70x100	304
	CGN4-G	-2/+8	632	233x70x85	243x80x100	304
	BSN4-G	-2/+8	550	233x60x85	243x70x100	430
	BGN4-G	-2/+8	632	233x70x85	243x80x100	430



Standard Line Series

Çekmece Seçenekleri / Drawer Options



- 3D** 1/3 Çekmece - 1/3 Drawers 597 €
- 2D** 1/2 Çekmece - 1/2 Drawers 469 €
- G** Cam Kapı - Glass Door 228 €
- 2/3D** 2/3 Çekmece - 2/3 Drawers 564 €

Cam Kapı Sadece Pozitif Kapılar İçindir
Glass Door Option is Only Available for Positive Doors

Bilgi

- * İç Derinlik: 43 Cm / 53 Cm (GN 1/1 Kapasiteli)
- * 35-40 Kg/m³ Çevre Dostu HCFC İçermeyen Poliüretan İzolasyon
- * Dijital Kumanda Paneli
- * Elektrik Rezistanslı Otomatik Defrost
- * Özel Su Buharlaştırma Sistemi
- * Yüksekliği Ayarlanabilir Paslanmaz Ayaklar
- * Özel, Kapı Mentеше Sistemi
- * Temizlenebilir ve Sökülebilir Manyetik Kapı Contası
- * Dış Ortam Sıcaklığı: + 43°C & % 65 Nem

Info

- * Inside Depth: 43 Cm / 53 Cm (GN 1/1 Capacity)
- * 35-40 Kg/m³ Ecology Friendly HCFC Free Polyurethane Insulation
- * Digital Control Panel
- * Electrical Resistor Automatic Defrost
- * Special Water Evaporation
- * Stainless Steel Legs Adjustable For Height
- * Special Door and Hinge Systems
- * Removable and Easy Cleaning Magnetic Gaskets
- * Ambient Temperature: + 43°C %65 Humidity

Kod Özellikleri Available Codes

Raf ve Raf Kızağı Shelf and Shelf Holder 49 €	A 70 € 10 cm Yuvarlatılmış Sırtlı Tabla 10 cm Curved Splashback Work Top
DZ 0 € Düz Üst Tabla Straight Work Top	MR 628 € Mermer Üst Tabla Marble Work Top
GR 1.249 € Granit Üst Tabla Granite Work Top	F 304 : -194 € 430 : -142 € Üst Tablasız Without Work Top
PL 1.197 € Polietilen Üst Tabla Polyethylene Work Top	T 217 € Touch Dijital Touch Digital
DKP 30 € Dijital Koruma Plastiği Digital Cover	RD 45 € Yuvarlatılmış Tabla Curved Work Top
WP 137 € Su Geçirmez Dijital Water Proof Digital	W 90 € Tekerlekli Wheels
BT 418 € Wi-Fi Dijital Wi-Fi Digital	60hz 56 € 220 V 60 Hz
K 70 €/Unt Kilitli Kapı With Lock	
L 30 € Sol Motor (Dikey) Left Motor (Upright)	

İzolasyon Kalınlığı Insulation Thickness	Raf Adedi Shelf Unit	Soğutma Gazı Cooling Gas	Voltaj Voltage	Enerji Sınıfı Energy Rating	Fiyat Price €	Model Models	Fiyat Price
50 mm	4	R134A	220 V / 50 Hz	E	3.560 €	CSN4-R290	3.533 €
50 mm	4	R134A	220 V / 50 Hz	E	3.693 €	CGN4-R290	3.665 €
50 mm	4	R404A	220 V / 50 Hz	E	5.274 €	CSL4-R290	5.247 €
50 mm	4	R404A	220 V / 50 Hz	E	5.523 €	CGL4-R290	5.320 €
50 mm	4	R134A	220 V / 50 Hz	E	2.843 €	BSN4-R290	2.817 €
50 mm	4	R134A	220 V / 50 Hz	E	3.031 €	BGN4-R290	3.005 €
50 mm	4	R404A	220 V / 50 Hz	E	4.478 €	BSL4-R290	4.452 €
50 mm	4	R404A	220 V / 50 Hz	E	4.765 €	BGL4-R290	4.564 €
50 mm	4	R134A	220 V / 50 Hz	E	4.447 €	CSN4-G-R290	4.419 €
50 mm	4	R134A	220 V / 50 Hz	E	4.580 €	CGN4-G-R290	4.552 €
50 mm	4	R134A	220 V / 50 Hz	E	3.688 €	BSN4-G-R290	3.662 €
50 mm	4	R134A	220 V / 50 Hz	E	3.794 €	BGN4-G-R290	3.767 €

Yatay Buzdolapları 4 Kapılı - EF Serisi

Counter Type Refrigerators 4 Door - EF Series

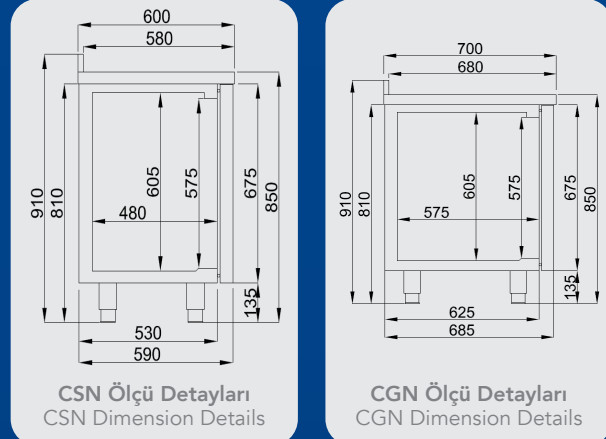
CSN Ölçü Detayları
CSN Dimension DetailsCGN Ölçü Detayları
CGN Dimension Details

CGN4-EF-R290

115 V / 60 Hz



R290

Option : 189 €

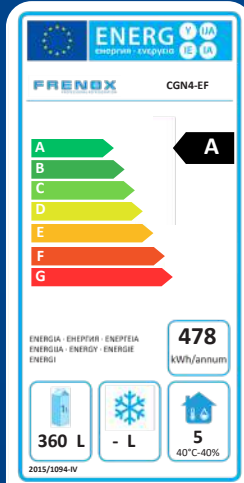
Elektrik Testi
EN ISO 22041:2019
Standartlarında yapılmıştır.Electricity Consumption
Test is Hold Under EN ISO
22041:2019 Standard.

KF

153€
Fanlı Kanopi
Canopy With FanStandart Sirt Yüksekliği 6
cm'dir.Standart Splash Back
Height is 6 cmDerin Dondurucularda Kanopide Fan Mevcuttur.
Deep Freezers Have Fan On The CanopyFRENEX
PROFESSIONAL REFRIGERATION

Standard Line Series

Çekmece Seçenekleri / Drawer Options

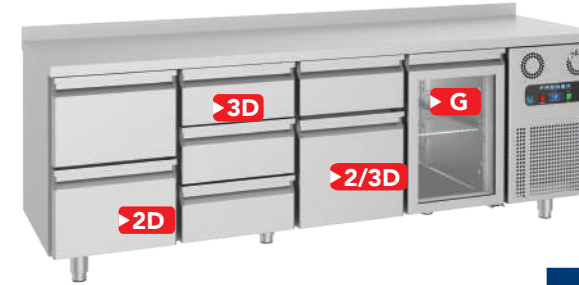

3D 1/3 Çekmece - 1/3 Drawers 597 €

2D 1/2 Çekmece - 1/2 Drawers 469 €

G Cam Kapı - Glass Door 228 €

2/3D 2/3 Çekmece - 2/3 Drawers 564 €

Cam Kapı Sadece Pozitif Kapılar İçindir
Glass Door Option is Only Available for Positive Doors

Bilgi

- * İç Derinlik: 43 Cm / 53 Cm (GN 1/1 Kapasiteli)
- * 35-40 Kg/m³ Çevre Dostu HCFC İçermeyen Poliüretan İzolasyon
- * Dijital Kumanda Paneli
- * Elektrik Rezistanslı Otomatik Defrost
- * Özel Su Buharlaştırma Sistemi
- * Yüksekliği Ayarlanabilir Paslanmaz Ayaklar
- * Özel, Kapı Mentеше Sistemi
- * Temizlenebilir ve Sökülebilir Manyetik Kapı Contası
- * Dış Ortam Sıcaklığı: + 43°C & % 65 Nem

Info

- * Inside Depth: 43 Cm / 53 Cm (GN 1/1 Capacity)
- * 35-40 Kg/m³ Ecology Friendly HCFC Free Polyurethane Insulation
- * Digital Control Panel
- * Electrical Resistor Automatic Defrost
- * Special Water Evaporation
- * Stainless Steel Legs Adjustable For Height
- * Special Door and Hinge Systems
- * Removable and Easy Cleaning Magnetic Gaskets
- * Ambient Temperature: + 43°C %65 Humidity

Kod Özellikleri
Available Codes

Raf ve Raf Kızağı Shelf and Shelf Holder 49 €	A 70 €
DZ 0 €	MR 628 €
Düz Üst Tabla Straight Work Top	Mermer Üst Tabla Marble Work Top
GR 1.249 €	F 304 : 197 € 430 : 142 €
Granit Üst Tabla Granite Work Top	Üst Tablasız Without Work Top
PL 1.197 €	T 217 €
Polyetilen Üst Tabla Polyethylene Work Top	Touch Dijital Touch Digital
DKP 30 €	RD 45 €
Dijital Koruma Plastiği Digital Cover	Yuvarlatılmış Tabla Curved Work Top
WP 137 €	W 90 €
Su Geçirmez Dijital Water Proof Digital	Tekerlekli Wheels
BT 418 €	60hz 56 €
Wi-Fi Dijital Wi-Fi Digital	220 V 60 Hz
K 70 €/Unt	L 30 €
Kilitli Kapı With Lock	Sol Motor (Dikey) Left Motor (Upright)

Model Models	İç Sıcaklık Temperature °C	Brüt Hacim Gross volume Lt.	Ölçüler Dimensions Cm.	Paket Ölçüsü Packing Dim. Cm.	Ağırlık Weight Kg.	Paslanmaz Özelliği Stainless Steel Type
CSN4-EF-R290	-2/+8	550	233x60x85	243x70x100	200	304
CGN4 EF-R290	-2/+8	632	233x70x85	243x80x100	205	304
BSN4 EF-R290	-2/+8	550	233x60x85	243x70x100	200	430
BGN4 EF-R290	-2/+8	632	233x70x85	243x80x100	205	430
CSN4-G EF-R290	-2/+8	550	233x60x85	243x70x100	215	304
CGN4-G EF-R290	-2/+8	632	233x70x85	243x80x100	220	304
BSN4-G EF-R290	-2/+8	550	233x60x85	243x70x100	215	430
BGN4-G EF-R290	-2/+8	632	233x70x85	243x80x100	220	430

İzolasyon Kalınlığı Insulation Thickness	Raf Adedi Shelf Unit	Soğutma Gazı Cooling Gas	Voltaj Voltage	Enerji Sınıfı Energy Rating
50 mm	4	R290	220 V / 50 Hz	A
50 mm	4	R290	220 V / 50 Hz	A
50 mm	4	R290	220 V / 50 Hz	A
50 mm	4	R290	220 V / 50 Hz	A
50 mm	4	R290	220 V / 50 Hz	B
50 mm	4	R290	220 V / 50 Hz	B
50 mm	4	R290	220 V / 50 Hz	B
50 mm	4	R290	220 V / 50 Hz	B

Model Models	Fiyat Price
CSN4-EF-R290	3.639 €
CGN4-EF-R290	3.771 €
BSN4-EF-R290	2.923 €
BGN4-EF-R290	3.112 €
CSN4-G-EF-R290	4.526 €
CGN4-G-EF-R290	4.658 €
BSN4-G-EF-R290	3.768 €
BGN4-G-EF-R290	3.873 €

EF: Bu modellerde energy efficiency kondenser fanı kullanılmaktadır. / These models have energy efficiency condenser fans.

Yatay Buzdolapları-Sürgü Cam Kapılı

Counter Type Refrigerators-Sliding Glass Door

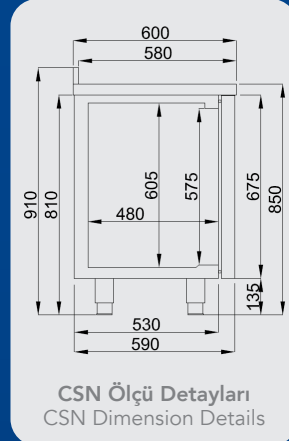
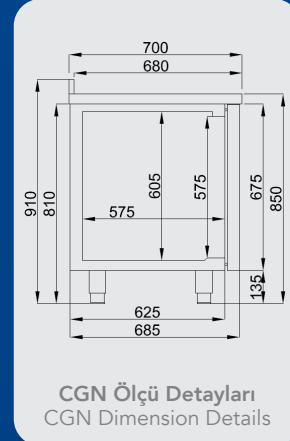
CSN Ölçü Detayları
CSN Dimension DetailsCGN Ölçü Detayları
CGN Dimension Details

Option : 189 €

115 V / 60 Hz



CGN3-SL



Standart Sırt Yüksekliği 6 cm'dir.

Standart Splash Back Height is 6 cm



Standard Line Series



Bilgi

- * İç Derinlik: 43 Cm / 53 Cm (GN 1/1 Kapasiteli)
- * 35-40 Kg/m³ Çevre Dostu HCFC İçermeyen Poliüretan İzolasyon
- * Dijital Kumanda Paneli
- * Elektrik Rezistanslı Otomatik Defrost
- * Özel Su Buharlaştırma Sistemi
- * Yüksekliği Ayarlanabilir Paslanmaz Ayaklar
- * Özel, Kapı Mentеше Sistemi
- * Temizlenebilir ve Sökülebilir Manyetik Kapı Contası
- * Dış Ortam Sıcaklığı: + 43°C & % 65 Nem

Info

- * Inside Depth: 43 Cm / 53 Cm (GN 1/1 Capacity)
- * 35-40 Kg/m³ Ecology Friendly HCFC Free Polyurethane Insulation
- * Digital Control Panel
- * Electrical Resistor Automatic Defrost
- * Special Water Evaporation
- * Stainless Steel Legs Adjustable For Height
- * Special Door and Hinge Systems
- * Removable and Easy Cleaning Magnetic Gaskets
- * Ambient Temperature: + 43°C %65 Humidity

Kod Özellikleri
Available Codes

Raf ve Raf Kızağı Shelf and Shelf Holder	49 €	A	70 €
Düz Üst Tabla Straight Work Top	0 €	MR	2 Door 429 € 3 Door 536 €
Granit Üst Tabla Granite Work Top	2 Door 823 € 3 Door 1.057 €	F	2 Door 183 € 3 Door 174 €
Polietilen Üst Tabla Polyethylene Work Top	2 Door 785 € 3 Door 1.016 €	T	217 €
DKP	30 €	60hz	56 €
Dijital Koruma Plastiği Digital Cover			220 V 60 hz
WP	137 €	L	30 €
Su Geçirmez Dijital Water Proof Digital			Sol Motor (Dikey) Left Motor (Upright)
BT	418 €	RD	45 €
Wi-Fi Dijital Wi-Fi Digital			Yuvarlatılmış Tabla Curved Work Top
W	90 €		Tekerlekli Wheels

Model Models	İç Sıcaklık Temperature °C	Brüt Hacim Gross volume Lt.	Ölçüler Dimensions Cm.	Paket Ölçüsü Packing Dim. Cm.	Ağırlık Weight Kg.	Paslanmaz Özelliği Stainless Steel Type
 CGN2-SL	-2/+8	281	140x70x85	150x80x100	141	304
 CSN2-SL	-2/+8	250	140x60x85	150x70x100	136	304
 CGN3-SL	-2/+8	474	186,5x70x85	197x80x100	170	304
 CSN3-SL	-2/+8	400	186,5x60x85	197x70x100	165	304

İzolasyon Kalınlığı Insulation Thickness	Raf Adedi Shelf Unit	Soğutma Gazı Cooling Gas	Voltaj Voltage	Enerji Sınıfı Energy Rating	Fiyat Price €	Model Models	Fiyat Price
50 mm	2	R134A	220 V / 50 Hz	E	2.983 €	CGN2-SL-R290	2.956 €
50 mm	2	R134A	220 V / 50 Hz	E	2.910 €	CSN2-SL-R290	2.882 €
50 mm	3	R134A	220 V / 50 Hz	E	3.870 €	CGN3-SL-R290	3.842 €
50 mm	3	R134A	220 V / 50 Hz	E	3.797 €	CSN3-SL-R290	3.769 €

Yatay Buzdolapları - Kısa

Counter Type Refrigerators - Short

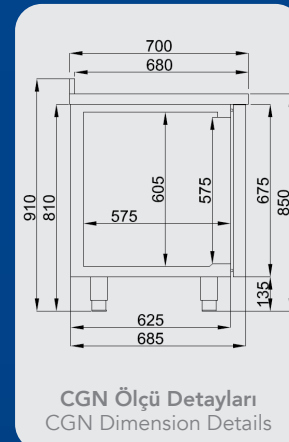
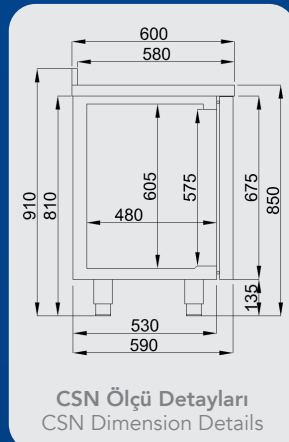

Option : 189 €

115 V / 60 Hz



CGN3-SH

KF



89 €

Fanlı Kanopi
Canopy With Fan

Standart Sırt Yüksekliği 6
cm'dir.

Standart Splash Back
Height is 6 cm



FRENOX
PROFESSIONAL REFRIGERATION

Standard Line Series

Çekmece Seçenekleri / Drawer Options



3D 1/3 Çekmece - 1/3 Drawers 597 €

2D 1/2 Çekmece - 1/2 Drawers 469 €

G Cam Kapı - Glass Door 228 €

2/3D 2/3 Çekmece - 2/3 Drawers 564 €

Cam Kapı Sadece Pozitif Kapılar İçindir
Glass Door Option is Only Available for Positive Doors

Bilgi

- * İç Derinlik: 43 Cm / 53 Cm (GN 1/1 Kapasiteli)
- * 35-40 Kg/m³ Çevre Dostu HCFC İçermeyen Poliüretan İzolasyon
- * Dijital Kumanda Paneli
- * Elektrik Rezistanslı Otomatik Defrost
- * Özel Su Buharlaştırma Sistemi
- * Yüksekliği Ayarlanabilir Paslanmaz Ayaklar
- * Özel, Kapı Mentеше Sistemi
- * Temizlenebilir ve Sökülebilir Manyetik Kapı Contası
- * Dış Ortam Sıcaklığı: + 43°C & % 65 Nem

Info

- * Inside Depth: 43 Cm / 53 Cm (GN 1/1 Capacity)
- * 35-40 Kg/m³ Ecology Friendly HCFC Free Polyurethane Insulation
- * Digital Control Panel
- * Electrical Resistor Automatic Defrost
- * Special Water Evaporation
- * Stainless Steel Legs Adjustable For Height
- * Special Door and Hinge Systems
- * Removable and Easy Cleaning Magnetic Gaskets
- * Ambient Temperature: + 43°C %65 Humidity

Kod Özellikleri

Available Codes

Raf ve Raf Kızağı Shelf and Shelf Holder 49 €

GR 2 Door 784 €
3 Door 960 €
4 Door 1249 €

Granit Üst Tabla Granite Work Top

DZ 0 €

Düz Üst Tabla Straight Work Top

PL 2 Door 779 €
3 Door 932 €
4 Door 1197 €

Poliütilen Üst Tabla Polyethylene Work Top

MR 2 Door 388 €
3 Door 481 €
4 Door 628 €

Mermer Üst Tabla Marble Work Top

DKP 30 €

Dijital Koruma Plastiği Digital Cover

F 2 Door -155 €
3 Door -174 €
4 Door -194 €

Üst Tablasız Without Work Top

BT 418 €

Wi-Fi Dijital Wi-Fi Digital

WP 137 €

Su Geçirmez Dijital Water Proof Digital

W 90 €

Tekerlekli Wheels

K 70 €/Unt

Kilitli Kapı With Lock

60_{hz} 56 €

220 V
60 hz

L 30 €

Sol Motor (Dikey) Left Motor (Upright)

RD 45 €

Yuvarlatılmış Tabla Curved Work Top

Model Models	İç Sıcaklık Temperature °C	Brüt Hacim Gross volume Lt.	Ölçüler Dimensions Cm.	Paket Ölçüsü Packing Dim. Cm.	Ağırlık Weight Kg.	Paslanmaz Özelliği Stainless Steel Type	
	CGN2-SH	-2/+8	281	120x70x85	130x80x100	130	304
	CSN2-SH	-2/+8	250	120x60x85	130x70x100	125	304
	CGN3-SH	-2/+8	474	160x70x85	175x80x100	160	304
	CSN3-SH	-2/+8	395	160x60x85	175x70x100	155	304
	CGN4-SH	-2/+8	632	213x70x85	223x80x100	190	304
	CSN4-SH	-2/+8	550	213x60x85	223x70x100	185	304

İzolasyon Kalınlığı Insulation Thickness	Raf Adedi Shelf Unit	Soğutma Gazı Cooling Gas	Voltaj Voltage	Enerji Sınıfı Energy Rating	Fiyat Price €	Model Models	Fiyat Price
50 mm	2	R134A	220 V / 50 Hz	E	2.688 €	CGN2-SH-R290	2.660 €
50 mm	2	R134A	220 V / 50 Hz	E	2.614 €	CSN2-SH-R290	2.587 €
50 mm	3	R134A	220 V / 50 Hz	E	3.131 €	CGN3-SH-R290	3.103 €
50 mm	3	R134A	220 V / 50 Hz	E	3.058 €	CSN3-SH-R290	3.030 €
50 mm	4	R134A	220 V / 50 Hz	E	3.722 €	CGN4-SH-R290	3.694 €
50 mm	4	R134A	220 V / 50 Hz	E	3.649 €	CSN4-SH-R290	3.621 €

Evyeli Yatay Buzdolapları

Counter Type Refrigerators W/Sink

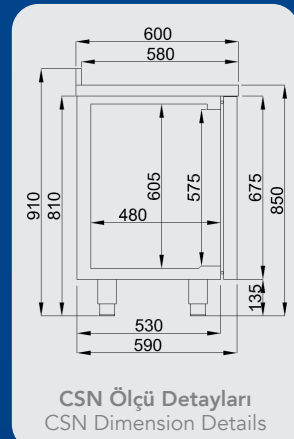

CSN Ölçü Detayları
CSN Dimension Details

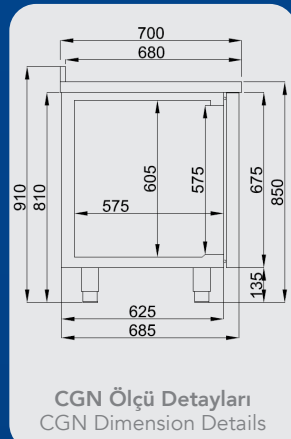

CGN Ölçü Detayları
CGN Dimension Details

Option : 189 €

115 V / 60 Hz

Evye Ölçüsü
Sink
Dimension
35x40x20 cm



Standart Sırt Yüksekliği 6 cm'dir.

Standart Splash Back Height is 6 cm



FRENOX
PROFESSIONAL REFRIGERATION

Standard Line Series

Çekmece Seçenekleri / Drawer Options

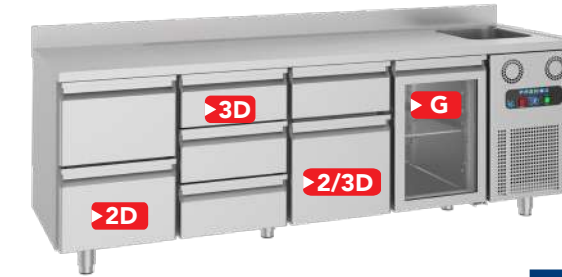

- >3D 1/3 Çekmece - 1/3 Drawers 597 €
- >2D 1/2 Çekmece - 1/2 Drawers 469 €
- >G Cam Kapı - Glass Door 228 €
- >2/3D 2/3 Çekmece - 2/3 Drawers 564 €

Cam Kapı Sadece Pozitif Kapılar İçindir
Glass Door Option is Only Available for Positive Doors

Bilgi

- * İç Derinlik: 43 Cm / 53 Cm (GN 1/1 Kapasiteli)
- * 35-40 Kg/m³ Çevre Dostu HCFC İçermeyen Poliüretan İzolasyon
- * Dijital Kumanda Paneli
- * Elektrik Rezistanslı Otomatik Defrost
- * Özel Su Buharlaştırma Sistemi
- * Yüksekliği Ayarlanabilir Paslanmaz Ayaklar
- * Özel, Kapı Mentеше Sistemi
- * Temizlenebilir ve Sökülebilir Manyetik Kapı Contası
- * Dış Ortam Sıcaklığı: + 43°C & % 65 Nem

Info

- * Inside Depth: 43 Cm / 53 Cm (GN 1/1 Capacity)
- * 35-40 Kg/m³ Ecology Friendly HCFC Free Polyurethane Insulation
- * Digital Control Panel
- * Electrical Resistor Automatic Defrost
- * Special Water Evaporation
- * Stainless Steel Legs Adjustable For Height
- * Special Door and Hinge Systems
- * Removable and Easy Cleaning Magnetic Gaskets
- * Ambient Temperature: + 43°C %65 Humidity

Kod Özellikleri

Available Codes

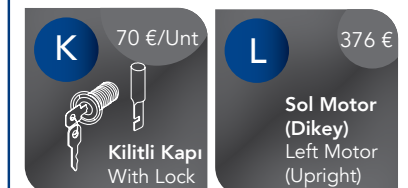
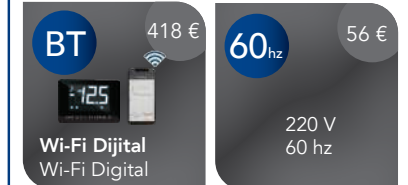

CGN3-E

Model Models	İç Sıcaklık Temperature °C	Brüt Hacim Gross volume Lt.	Ölçüler Dimensions Cm.	Paket Ölçüsü Packing Dim. Cm.	Ağırlık Weight Kg.	Paslanmaz Özellikli Stainless Steel Type	
	CSN2-E	-2/+8	250	140x60x85	150x70x105	130	304
	CGN2-E	-2/+8	281	140x70x85	150x80x105	136	304
	CSN3-E	-2/+8	400	186,5x60x85	196x70x105	162	304
	CGN3-E	-2/+8	474	186,5x70x85	196x80x105	170	304
	CSN4-E	-2/+8	550	233x60x85	243x70x105	196	304
	CGN4-E	-2/+8	632	233x70x85	243x80x105	205	304

İzolasyon Kalınlığı Insulation Thickness	Raf Adedi Shelf Unit	Soğutma Gazı Cooling Gas	Voltaj Voltage	Enerji Sınıfı Energy Rating	Fiyat Price €	Model Models	Fiyat Price
50 mm	2	R134A	220 V / 50 Hz	E	2.983 €	CSN2-E-R290	2.956 €
50 mm	2	R134A	220 V / 50 Hz	E	3.058 €	CGN2-E-R290	3.030 €
50 mm	3	R134A	220 V / 50 Hz	E	3.685 €	CSN3-E-R290	3.657 €
50 mm	3	R134A	220 V / 50 Hz	E	3.759 €	CGN3-E-R290	3.732 €
50 mm	4	R134A	220 V / 50 Hz	E	4.313 €	CSN4-E-R290	4.286 €
50 mm	4	R134A	220 V / 50 Hz	E	4.333 €	CGN4-E-R290	4.360 €

Cihaz Altı Buzdolapları / Statik Soğutmalı

Undercounter Refrigerators / Static Cooled

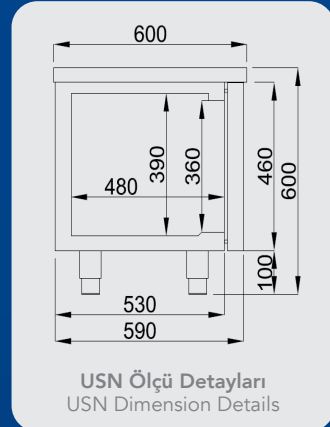

USN Ölçü Detayları
USN Dimension Details

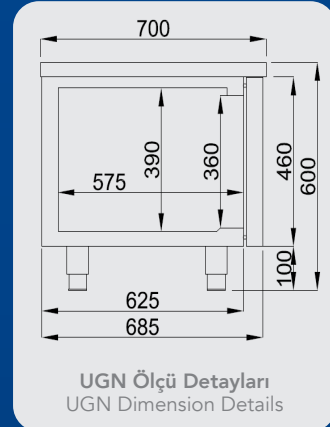

UGN Ölçü Detayları
UGN Dimension Details

Option : 189 €

115 V / 60 Hz



Standart üretim düz tabladır.

Standard production is straight work top.

Standart üretim kapılıdır. Çekmece için yan tablodan fiyat ekleyiniz.

Standard production is with doors. To add drawers include the price from the table in next page.

* Üstüne kömürlü ızgara veya lav taşı ızgara koyulacağı zaman ekstra izolasyon yapılmalıdır.



UGN1-ST



FRENOX
PROFESSIONAL REFRIGERATION

Standard Line Series



USN1-ST

Bilgi

- * 35-40 Kg/m³ Çevre Dostu HCFC İçermeyen Poliüretan İzolasyon
- * Dijital Kumanda Paneli
- * Elektrik Rezistanslı Otomatik Defrost
- * Özel Su Buharlaştırma Sistemi
- * Yüksekliği Ayarlanabilir Paslanmaz Ayaklar
- * Özel, Kapı Mentеше Sistemi
- * Temizlenebilir ve Sökülebilir Manyetik Kapı Contası
- * Dış Ortam Sıcaklığı: + 32°C & % 40 Nem



Info

- * 35-40 Kg/m³ Ecology Friendly HCFC Free Polyurethane Insulation
- * Digital Control Panel
- * Electrical Resistor Automatic Defrost
- * Special Water Evaporation
- * Stainless Steel Legs Adjustable For Height
- * Special Door and Hinge Systems
- * Removable and Easy Cleaning Magnetic Gaskets
- * Ambient Temperature: + 32°C 40% Humidity

Kod Özellikleri

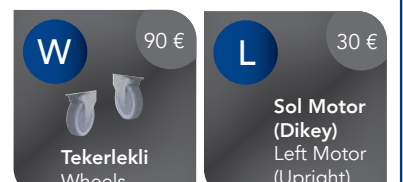
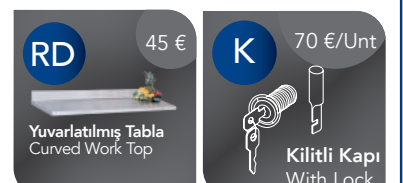
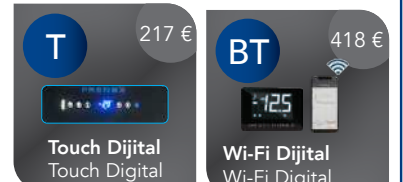
Available Codes



Model Models	İç Sıcaklık Temperature °C	Brüt Hacim Gross volume Lt.	Ölçüler Dimensions Cm.	Paket Ölçüsü Packing Dim. Cm.	Ağırlık Weight Kg.	Paslanmaz Özelligi Stainless Steel Type
 UGN1-ST	-2/+8	75	80x60x60	83x70x75	50	304
 USN1-ST	-2/+8	90	80x70x60	83x80x75	45	304

İzolasyon Kalınlığı Insulation Thickness	Raf Adedi Shelf Unit	Soğutma Gazı Cooling Gas	Voltaj Voltage	Enerji Sınıfı Energy Rating	Model Models	Fiyat Price
50 mm	1	R290	220V / 50 Hz	E	UGN1-ST	2.009 €
50 mm	1	R290	220V / 50 Hz	E	USN1-ST	1.983 €

Cihaz Altı Buzdolapları

Undercounter Refrigerators

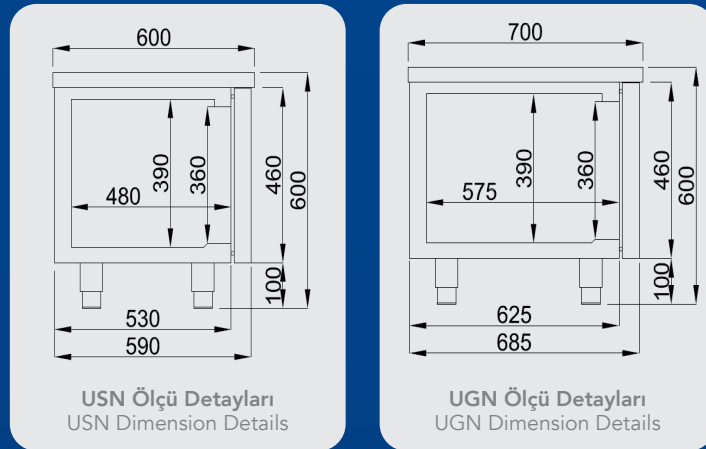

Option : 189 €

115 V / 60 Hz



UGN3

* Üstüne kömürlü ızgara veya lav taşı ızgara koyulacağı zaman ekstra izolasyon yapılmalıdır.

Standart üretim düz tablalıdır.

Standard production is straight work top.

Standart üretim kapılıdır. Çekmece için yan tablodan fiyat ekleyiniz.

Standard production is with doors. To add drawers include the price from the table in next page.



Standard Line Series

Çekmece Seçenekleri / Drawer Options

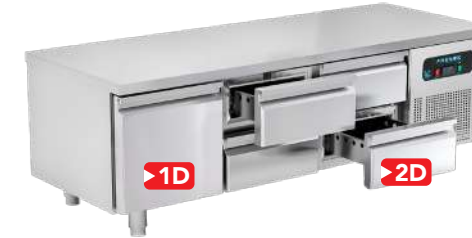

1D 1/1 Çekmece - 1/1 Drawers 191 €

2D 1/2 Çekmece - 1/2 Drawers 339 €

Bilgi

- * İç Derinlik: 43 Cm / 53 Cm (GN 1/1 Kapasiteli)
- * 35-40 Kg/m³ Çevre Dostu HCFC İçermeyen Poliüretan İzolasyon
- * Dijital Kumanda Paneli
- * Elektrik Rezistanslı Otomatik Defrost
- * Özel Su Buharlaştırma Sistemi
- * Yüksekliği Ayarlanabilir Paslanmaz Ayaklar
- * Özel, Kapı Mentеше Sistemi
- * Temizlenebilir ve Sökülebilir Manyetik Kapı Contası
- * Dış Ortam Sıcaklığı: + 43°C & % 65 Nem

Info

- * Inside Depth: 43 Cm / 53 Cm (GN 1/1 Capacity)
- * 35-40 Kg/m³ Ecology Friendly HCFC Free Polyurethane Insulation
- * Digital Control Panel
- * Electrical Resistor Automatic Defrost
- * Special Water Evaporation
- * Stainless Steel Legs Adjustable For Height
- * Special Door and Hinge Systems
- * Removable and Easy Cleaning Magnetic Gaskets
- * Ambient Temperature: + 43°C %65 Humidity

Kod Özellikleri

Available Codes

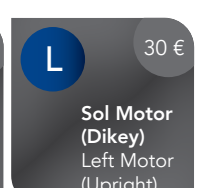
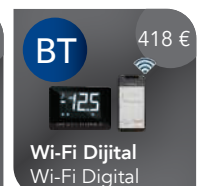
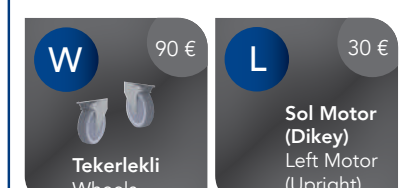
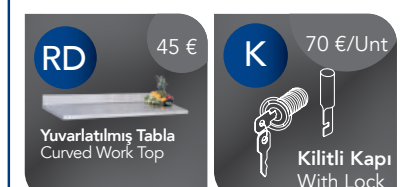

Model Models	İç Sıcaklık Temperature °C	Brüt Hacim Gross volume Lt.	Ölçüler Dimensions Cm.	Paket Ölçüsü Packing Dim. Cm.	Ağırlık Weight Kg.	Paslanmaz Özelliği Stainless Steel Type	
	USN2	-2/+8	150	140x60x60	150x70x75	110	304
	UGN2	-2/+8	180	140x70x60	150x80x75	120	304
	USL2	-10/-20	150	140x60x60	150x70x75	115	304
	UGL2	-10/-20	180	140x70x60	150x80x75	125	304
	USN3	-2/+8	235	186,5x60x60	197x70x75	150	304
	UGN3	-2/+8	280	186,5x70x60	197x80x75	160	304
	USL3	-10/-20	235	186,5x60x60	197x70x75	155	304
	UGL3	-10/-20	280	186,5x70x60	197x80x75	165	304
	USN4	-2/+8	300	233x60x60	243x70x75	180	304
	UGN4	-2/+8	360	233x70x60	243x80x75	185	304
	USL4	-10/-20	300	233x60x60	243x70x75	185	304
	UGL4	-10/-20	360	233x70x60	243x80x75	195	304

İzolasyon Kalınlığı Insulation Thickness	Raf Adedi Shelf Unit	Soğutma Gazı Cooling Gas	Voltaj Voltage	Enerji Sınıfı Energy Rating	Fiyat Price €	Model Models	Fiyat Price
50 mm	2	R134A	220 V / 50 Hz	D	1.976 €	USN2-R290	1.923 €
50 mm	2	R134A	220 V / 50 Hz	D	1.989 €	UGN2-R290	1.936 €
50 mm	2	R404A	220 V / 50 Hz	E	2.732 €	USL2-R290	2.679 €
50 mm	2	R404A	220 V / 50 Hz	E	2.758 €	UGL2-R290	2.705 €
50 mm	3	R134A	220 V / 50 Hz	D	2.295 €	USN3-R290	2.242 €
50 mm	3	R134A	220 V / 50 Hz	D	2.307 €	UGN3-R290	2.254 €
50 mm	3	R404A	220 V / 50 Hz	E	2.944 €	USL3-290	2.891 €
50 mm	3	R404A	220 V / 50 Hz	E	2.971 €	UGL3-R290	2.917 €
50 mm	4	R134A	220 V / 50 Hz	D	3.103 €	USN4-R290	3.050 €
50 mm	4	R134A	220 V / 50 Hz	D	3.130 €	UGN4-R290	3.077 €
50 mm	4	R404A	220 V / 50 Hz	E	3.793 €	USL4-R290	3.740 €
50 mm	4	R404A	220 V / 50 Hz	E	3.819 €	UGL4-R290	3.766 €

Cihaz Altı Buzdolapları

Undercounter Refrigerators

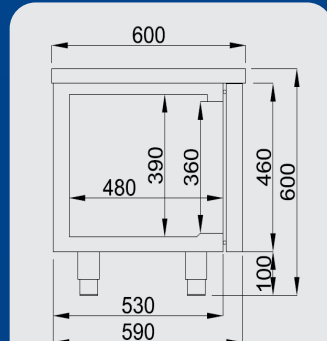

USN Ölçü Detayları
USN Dimension Details

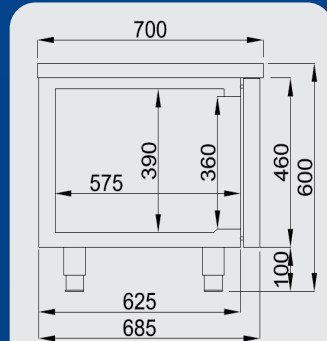

UGN Ölçü Detayları
UGN Dimension Details



Option : 189 €



Elektrik Testi
EN ISO 22041:2019
Standartlarında yapılmıştır.

Electricity Consumption
Test is Hold Under EN ISO
22041:2019 Standard.

115 V / 60 Hz



UGN3-EF

* Üstüne kömürlü ızgara veya lav taşı ızgara koyulacağı zaman ekstra izolasyon yapılmalıdır.

Standart üretim düz tablalıdır.

Standard production is straight work top.

Standart üretim kapılıdır. Çekmece için yan tablodan fiyat ekleyiniz.

Standard production is with doors. To add drawers include the price from the table in next page.



FRENOX
PROFESSIONAL REFRIGERATION

Standard Line Series

Çekmece Seçenekleri / Drawer Options

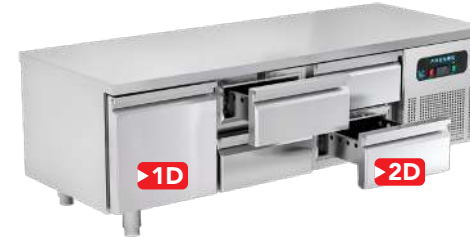

1D 1/1 Çekmece - 1/1 Drawers 191 €

2D 1/2 Çekmece - 1/2 Drawers 339 €

Bilgi

- * İç Derinlik: 43 Cm / 53 Cm (GN 1/1 Kapasiteli)
- * 35-40 Kg/m³ Çevre Dostu HCFC İçermeyen Poliüretan İzolasyon
- * Dijital Kumanda Paneli
- * Elektrik Rezistanslı Otomatik Defrost
- * Özel Su Buharlaştırma Sistemi
- * Yüksekliği Ayarlanabilir Paslanmaz Ayaklar
- * Özel, Kapı Mentеше Sistemi
- * Temizlenebilir ve Sökülebilir Manyetik Kapı Contası
- * Dış Ortam Sıcaklığı: + 43°C & % 65 Nem

Info

- * Inside Depth: 43 Cm / 53 Cm (GN 1/1 Capacity)
- * 35-40 Kg/m³ Ecology Friendly HCFC Free Polyurethane Insulation
- * Digital Control Panel
- * Electrical Resistor Automatic Defrost
- * Special Water Evaporation
- * Stainless Steel Legs Adjustable For Height
- * Special Door and Hinge Systems
- * Removable and Easy Cleaning Magnetic Gaskets
- * Ambient Temperature: + 43°C %65 Humidity

Kod Özellikleri

Available Codes

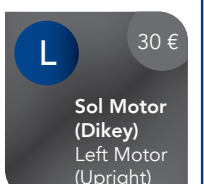
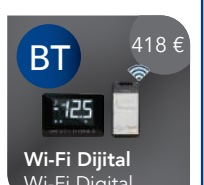
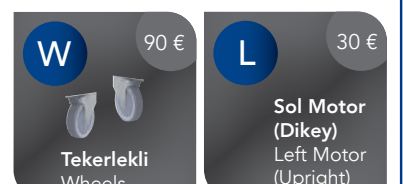
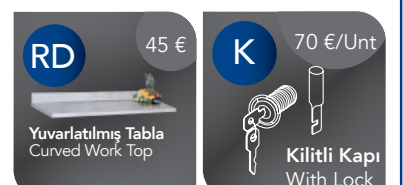
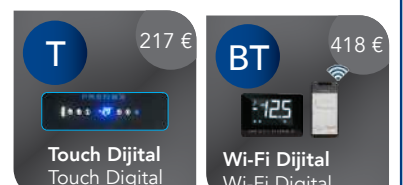

Model Models	İç Sıcaklık Temperature °C	Brüt Hacim Gross volume Lt.	Ölçüler Dimensions Cm.	Paket Ölçüsü Packing Dim. Cm.	Ağırlık Weight Kg.	Paslanmaz Özelliği Stainless Steel Type	
	USN2-EF	-2/+8	150	140x60x60	150x70x75	110	304
	UGN2-EF	-2/+8	180	140x70x60	150x80x75	120	304
	USN3-EF	-2/+8	235	186,5x60x60	197x70x75	150	304
	UGN3-EF	-2/+8	280	186,5x70x60	197x80x75	160	304
	USN4-EF	-2/+8	300	233x60x60	243x70x75	180	304
	UGN4-EF	-2/+8	360	233x70x60	243x80x75	185	304

İzolasyon Kalınlığı Insulation Thickness	Raf Adedi Shelf Unit	Soğutma Gazı Cooling Gas	Voltaj Voltage	Enerji Sınıfı Energy Rating	Model Models	Fiyat Price
50 mm	2	R290	220V / 50 Hz	A	USN2-EF	1.998 €
50 mm	2	R290	220V / 50 Hz	A	UGN2-EF	2.010 €
50 mm	3	R290	220V / 50 Hz	A	USN3-EF	2.337 €
50 mm	3	R290	220V / 50 Hz	A	UGN3-EF	2.350 €
50 mm	4	R290	220V / 50 Hz	A	USN4-EF	3.156 €
50 mm	4	R290	220V / 50 Hz	A	UGN4-EF	3.183 €

EF: Bu modellerde energy efficiency kondenser fanı kullanılmaktadır. / These models have energy efficiency condenser fans.

Cihaz Altı Buzdolapları-Kısa

Undercounter Refrigerators-Short

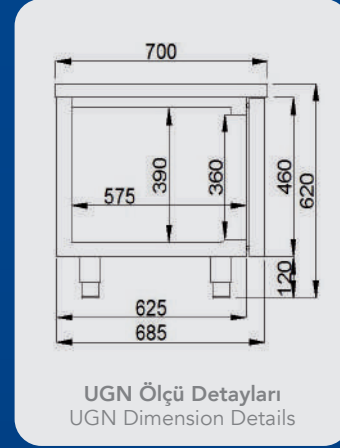
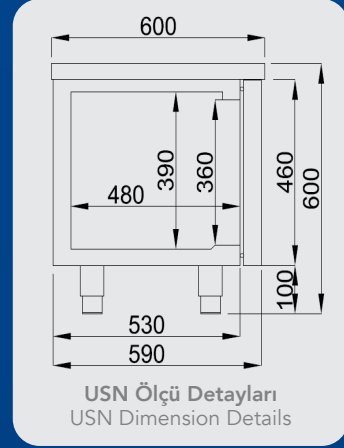

Option : 189 €

115 V / 60 Hz



UGN2-SH

* Üstüne kömürlü ızgara veya lav taşı ızgara koyulacağı zaman ekstra izolasyon yapılmalıdır.

Standart üretim düz tabladır.

Standard production is straight work top.

Standart üretim kapılıdır. Çekmece için yan tablodan fiyat ekleyiniz.

Standard production is with doors. To add drawers include the price from the table in next page.



Standard Line Series

Çekmece Seçenekleri / Drawer Options



1D 1/1 Çekmece - 1/1 Drawers 191 €

2D 1/2 Çekmece - 1/2 Drawers 339 €

Bilgi

- * İç Derinlik : 43 Cm / 53 Cm (GN 1/1 Kapasiteli)
- * 35-40 Kg/m³ Çevre Dostu HCFC İçermeyen Poliüretan İzolasyon
- * Dijital Kumanda Paneli
- * Elektrik Rezistanslı Otomatik Defrost
- * Özel Su Buharlaştırma Sistemi
- * Özel, Kapı Mentеше Sistemi
- * Temizlenebilir ve Sökülebilir Manyetik Kapı Contası
- * Dış Ortam Sıcaklığı: + 43°C & % 65 Nem

Info

- * Inside Depth: 43 Cm / 53 Cm (GN 1/1 Capacity)
- * 35-40 Kg/m³ Ecology Friendly HCFC Free Polyurethane İsolation
- * Digital Control Panel
- * Electrical Resistor Automatic Defrost
- * Special Water Evaporation
- * Special Hinges and Door System
- * Removable and Easy Cleaning Magnetic Gaskets
- * Ambient Temperature: + 43°C % 65 Humidity

Kod Özellikleri

Available Codes

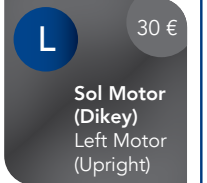
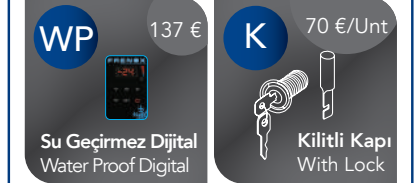

Model Models	İç Sıcaklık Temperature °C	Brüt Hacim Gross volume Lt.	Ölçüler Dimensions Cm.	Paket Ölçüsü Packing Dim. Cm.	Ağırlık Weight Kg.	Paslanmaz Özelliği Stainless Steel Type
 UGN2-SH	-2/+8	180	120x70x60	130x80x75	112	304
 USN2-SH	-2/+8	150	120x60x60	130x70x75	102	304
 UGN3-SH	-2/+8	280	160x70x60	170x80x75	145	304
 USN3-SH	-2/+8	235	160x60x60	170x70x75	135	304
UGN4-SH	-2/+8	360	220x70x60	230x80x75	170	304
USN4-SH	-2/+8	300	220x60x60	230x70x75	165	304

İzolasyon Kalınlığı Insulation Thickness	Raf Adedi Shelf Unit	Soğutma Gazı Cooling Gas	Voltaj Voltage	Enerji Sınıfı Energy Rating	Fiyat Price €	Model Models	Fiyat Price
50 mm	2	R134A	220 V / 50 Hz	D	2.228 €	UGN2-SH-R290	2.148 €
50 mm	2	R134A	220 V / 50 Hz	D	2.223 €	USN2-SH-R290	2.143 €
50 mm	3	R134A	220 V / 50 Hz	D	2.679 €	UGN3-SH-R290	2.467 €
50 mm	3	R134A	220 V / 50 Hz	D	2.673 €	USN3-SH-R290	2.461 €
50 mm	4	R134A	220 V / 50 Hz	D	3.501 €	UGN4-SH-R290	3.289 €
50 mm	4	R134A	220 V / 50 Hz	D	3.496 €	USN4-SH-R290	3.283 €

Cihaz Altı Derin Dondurucular-Kısa

Undercounter Freezers-Short

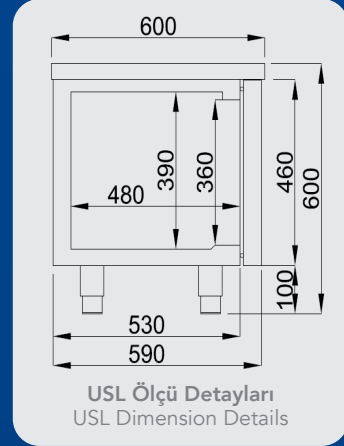

USL Ölçü Detayları
USL Dimension Details

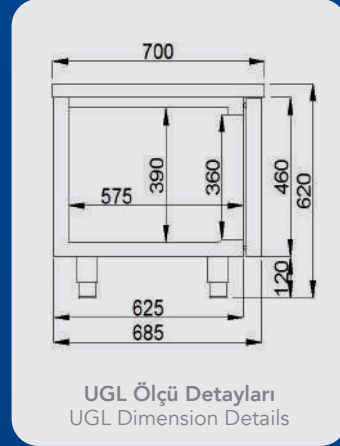

UGL Ölçü Detayları
UGL Dimension Details

Option : 184 €

115 V / 60 Hz



UGL2-SH

* Üstüne kömürlü ızgara veya lav taşı ızgara koyulacağı zaman ekstra izolasyon yapılmalıdır.

Standart üretim düz tabladır.

Standard production is straight work top.

Standart üretim kapılıdır. Çekmece için yan tablodan fiyat ekleyiniz.

Standard production is with doors. To add drawers include the price from the table in next page.



Standard Line Series

Çekmece Seçenekleri / Drawer Options

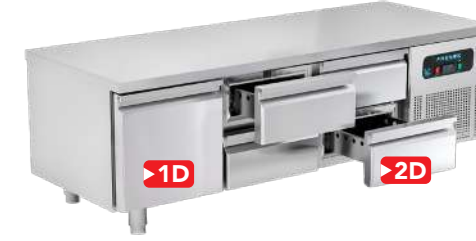

1D 1/1 Çekmece - 1/1 Drawers 191 €

2D 1/2 Çekmece - 1/2 Drawers 339 €

Bilgi

- * İç Derinlik : 43 Cm / 53 Cm (GN 1/1 Kapasiteli)
- * 35-40 Kg/m³ Çevre Dostu HCFC İçermeyen Poliüretan İzolasyon
- * Dijital Kumanda Paneli
- * Elektrik Rezistanslı Otomatik Defrost
- * Özel Su Buharlaştırma Sistemi
- * Özel, Kapı Mentеше Sistemi
- * Temizlenebilir ve Sökülebilir Manyetik Kapı Contası
- * Dış Ortam Sıcaklığı: + 32°C & %45 Nem

Info

- * Inside Depth: 43 Cm / 53 Cm (GN 1/1 Capacity)
- * 35-40 Kg/m³ Ecology Friendly HCFC Free Polyurethane Isolation
- * Digital Control Panel
- * Electrical Resistor Automatic Defrost
- * Special Water Evaporation
- * Special Hinges and Door System
- * Removable and Easy Cleaning Magnetic Gaskets
- * Ambient Temperature: + 32°C 45% Humidity

Kod Özellikleri

Available Codes

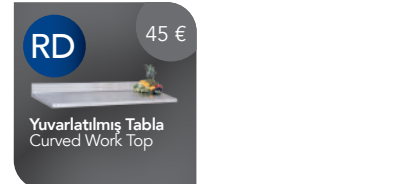
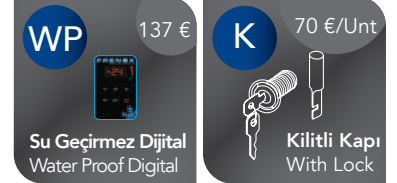

Model Models	İç Sıcaklık Temperature °C	Brüt Hacim Gross volume Lt.	Ölçüler Dimensions Cm.	Paket Ölçüsü Packing Dim. Cm.	Ağırlık Weight Kg.	Paslanmaz Özelliği Stainless Steel Type
 UGL2-SH	-10/-20	185	120x70x60	130x80x75	116	304
 USL2-SH	-10/-20	155	120x60x60	130x70x75	106	304
 UGL3-SH	-10/-20	285	160x70x60	170x80x75	149	304
 USL3-SH	-10/-20	240	160x60x60	170x70x75	139	304
UGL4-SH	-10/-20	365	220x70x60	230x80x75	174	304
USL4-SH	-10/-20	305	220x60x60	230x70x75	169	304

İzolasyon Kalınlığı Insulation Thickness	Raf Adedi Shelf Unit	Soğutma Gazı Cooling Gas	Voltaj Voltage	Enerji Sınıfı Energy Rating	Model Models	Fiyat Price
50 mm	2	R290	220 V / 50 Hz	D	UGL2-SH-R290	2.905 €
50 mm	2	R290	220 V / 50 Hz	D	USL2-SH-R290	2.854 €
50 mm	3	R290	220 V / 50 Hz	D	UGL3-SH-R290	3.193 €
50 mm	3	R290	220 V / 50 Hz	D	USL3-SH-R290	3.142 €
50 mm	4	R290	220 V / 50 Hz	D	UGL4-SH-R290	3.966 €
50 mm	4	R290	220 V / 50 Hz	D	USL4-SH-R290	3.914 €

Yatay Buzdolapları - Remote

Counter Type Refrigerators - Remote

R 404
Expansion
Valf
R 404
Expansion
Valve

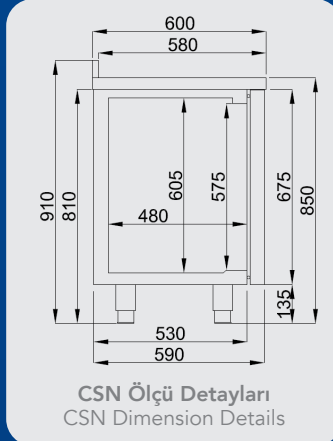

CSN Ölçü Detayları
CSN Dimension Details

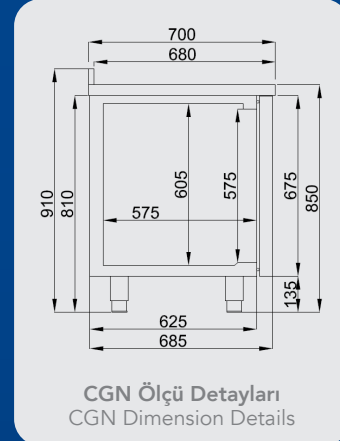

CGN Ölçü Detayları
CGN Dimension Details



CGN3-R



Standard Line Series

Uzaktan Kumanda Soğutma Grupları

Remote Control Cooling Group

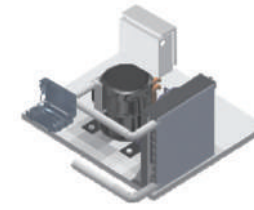

	Model	Price €
1	CGN2-R	902 €
2	CGN3-R	1013 €
3	CGN4-R	1331 €

Seçenekler / Options	Fiyat Price €
1/2 Çekmece 1/2 Drawers	469 €
1/3 Çekmece 1/3 Drawers	597 €

Remote Yatay Buzdolaplarında gövde ve soğutma grubu ayrı satılmaktadır. Gövdede expansion valve dahildir. Soğutma Grupları fiyatları için yukarıdaki tabloya bakınız.
Remote Counter Refrigerators body and cooling group are sold separately. Body have only expansion valve. For cooling group prices please check the table above.

Bilgi

- * İç Derinlik: 43 Cm / 53 Cm (GN 2/1 Kapasiteli)
- * 35-40 Kg/m³ Çevre Dostu HCFC İçermeyen Poliüretan İzolasyon
- * Fanlı Soğutma
- * Dijital Termometre & Termostat
- * Otomatik Defrost
- * Yüksekliği Ayarlanabilir Paslanmaz Ayaklar
- * Özel, Kapı Mentеше Sistemi
- * Temizlenebilir ve Sökülebilir Manyetik Kapı Contası
- * Plastik Kaplı Çelik Raf
- * Dış Ortam Sıcaklığı: + 32°C

Info

- * Inside Depth: 43 Cm / 53 Cm (GN 2/1 Capacity)
- * 35-40 Kg/m³ Ecology Friendly HCFC Free Polyurethane Insulation
- * Fan Cooling
- * Digital Thermometer & Thermostat
- * Automatic Defrost
- * Stainless Steel Legs Adjustable For Height
- * Special Door and Hinge Systems
- * Removable and Easy Cleaning Magnetic Gaskets
- * Plastic Coated Steel Shelf
- * Ambient Temperature: + 32°C

Kod Özellikleri

Available Codes

Raf ve Raf Kızağı Shelf and Shelf Holder 49 €	A 10 cm Yuvarlatılmış Sırtlı Tabla 10 cm Curved Splashback Work Top 70 €
DZ Düz Üst Tabla Straight Work Top 0 €	F Üst Tablasız Without Work Top 2 Door -155 € 3 Door -174 € 4 Door -194 €
GR Granit Üst Tabla Granite Work Top 2 Door 784 € 3 Door 960 € 4 Door 1249 €	MR Mermer Üst Tabla Marble Work Top 2 Door 388 € 3 Door 481 € 4 Door 628 €
PL Polietilen Üst Tabla Polyethylene Work Top 2 Door 779 € 3 Door 932 € 4 Door 1197 €	60_{hz} 220 V 60 hz 56 €
DKP Dijital Koruma Plastiği Digital Cover 30 €	W Tekerlekli Wheels 90 €
WP Su Geçirmez Dijital Water Proof Digital 137 €	K Kilitli Kapı With Lock 70 €/Unt
BT Wi-Fi Dijital Wi-Fi Digital 418 €	L Sol Motor (Dikey) Left Motor (Upright) 30 €

Model Models	İç Sıcaklık Temperature °C	Brüt Hacim Gross volume Lt.	Motor Grubu Cooling Group Kapasite/Capacity W	Ölçüler Dimensions Cm.	Paket Ölçüsü Packing Dim. Cm.	Ağırlık Weight Kg.	Paslanmaz Özellikli Stainless Steel Type
	CSN2-R	-2/+8	250	112,5x60x85	122,5x70x100	80	304
	CGN2-R	-2/+8	281	112,5x70x85	122,5x80x100	85	304
	CSN3-R	-2/+8	400	160x60x85	170x70x100	110	304
	CGN3-R	-2/+8	474	160x70x85	170x80x100	115	304
	CSN4-R	-2/+8	550	206x60x85	216x70x100	140	304
	CGN4-R	-2/+8	632	206x70x85	216x80x100	145	304

İzolasyon Kalınlığı Insulation Thickness	Raf Adedi Shelf Unit	Expansion Valf Expansion Valve	Voltaj Voltage	Fiyat Price €
50 mm	2	R404A	220 V / 50 Hz	2.425 €
50 mm	2	R404A	220 V / 50 Hz	2.566 €
50 mm	3	R404A	220 V / 50 Hz	2.927 €
50 mm	3	R404A	220 V / 50 Hz	2.960 €
50 mm	4	R404A	220 V / 50 Hz	3.649 €
50 mm	4	R404A	220 V / 50 Hz	3.707 €

Yatay Buzdolapları Bar Serisi

Counter Refrigerators Bar Series

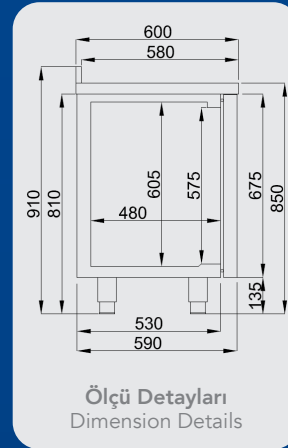

Ölçü Detayları
Dimension Details

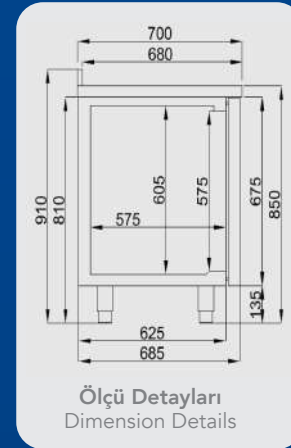

Ölçü Detayları
Dimension Details



CGN2-MT

Option : 189 €

115 V / 60 Hz

Standart Sirt Yüksekliği
6 cm'dir.

Standart Splash Back
Height is 6 cm



FRENOX
PROFESSIONAL REFRIGERATION

Standard Line Series

Çekmece Seçenekleri / Drawer Options

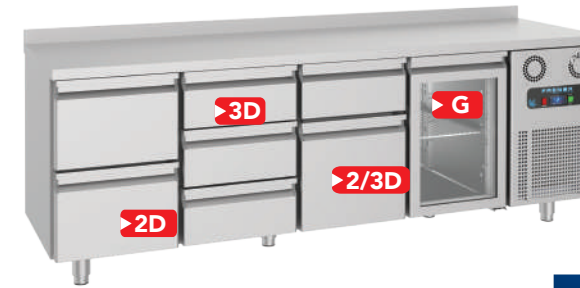

- 3D** 1/3 Çekmece - 1/3 Drawers 597 €
- 2D** 1/2 Çekmece - 1/2 Drawers 469 €
- G** Cam Kapı - Glass Door 228 €
- 2/3D** 2/3 Çekmece - 2/3 Drawers 564 €

Cam Kapı Sadece Pozitif Kapılar İçindir
Glass Door Option is Only Available for Positive Doors

Bilgi

- * İç Derinlik: 43 Cm / 53 Cm (GN 1/1 Kapasiteli)
- * 35-40 Kg/m³ Çevre Dostu HCFC İçermeyen Poliüretan İzolasyon
- * Dijital Kumanda Paneli
- * Elektrik Rezistanslı Otomatik Defrost
- * Özel Su Buharlaştırma Sistemi
- * Yüksekliği Ayarlanabilir Paslanmaz Ayaklar
- * Özel, Kapı Menteşe Sistemi
- * Temizlenebilir ve Sökülebilir Manyetik Kapı Contası
- * Dış Ortam Sıcaklığı: + 43°C & % 65 Nem





Info

- * Inside Depth: 43 Cm / 53 Cm (GN 1/1 Capacity)
- * 35-40 Kg/m³ Ecology Friendly HCFC Free Polyurethane Insulation
- * Digital Control Panel
- * Electrical Resistor Automatic Defrost
- * Special Water Evaporation
- * Stainless Steel Legs Adjustable For Height
- * Special Door and Hinge Systems
- * Removable and Easy Cleaning Magnetic Gaskets
- * Ambient Temperature: + 43°C %65 Humidity

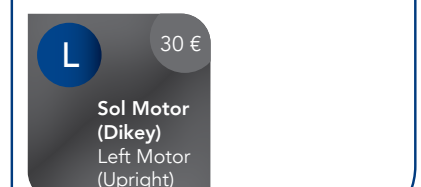
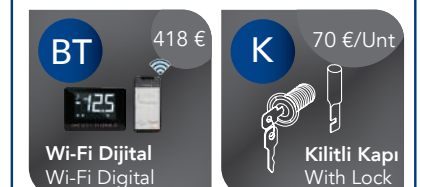
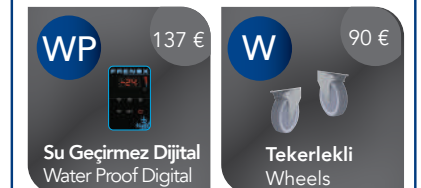
Kod Özellikleri

Available Codes



Model Models	İç Sıcaklık Temperature °C	Brüt Hacim Gross volume Lt.	Ölçüler Dimensions Cm.	Paket Ölçüsü Packing Dim. Cm.	Ağırlık Weight Kg.	Paslanmaz Özellikçi Stainless Steel Type
 CGN2-MT	-2/+8	281	140x70x85	150x80x100	145	304
 CSN2-MT	-2/+8	250	140x60x85	150x70x100	135	304
 CGN3-MT	-2/+8	474	186,5x70x85	197x80x100	170	304
 CSN3-MT	-2/+8	400	186,5x60x85	197x70x100	160	304
CGN4-MT	-2/+8	632	233x70x85	243x80x100	195	304
CSN4-MT	-2/+8	550	233x60x85	243x70x100	185	304

İzolasyon Kalınlığı Insulation Thickness	Raf Adedi Shelf Unit	Soğutma Gazı Cooling Gas	Voltaj Voltage	Enerji Sınıfı Energy Rating	Fiyat Price €	Model Models	Fiyat Price
50 mm	2	R134A	220 V / 50 Hz	E	2.772 €	CGN2-MT-R290	2.744 €
50 mm	2	R134A	220 V / 50 Hz	E	2.732 €	CSN2-MT-R290	2.704 €
50 mm	3	R134A	220 V / 50 Hz	E	3.399 €	CGN3-MT-R290	3.371 €
50 mm	3	R134A	220 V / 50 Hz	E	3.360 €	CSN3-MT-R290	3.333 €
50 mm	4	R134A	220 V / 50 Hz	E	3.987 €	CGN4-MT-R290	3.960 €
50 mm	4	R134A	220 V / 50 Hz	E	3.947 €	CSN4-MT-R290	3.920 €



Dikey Buzdolapları 1 Kapılı/Prof. Line
Vertical Refrigerators 1 Door/Prof. Line

76-77

78-79 **EF Dikey Buzdolapları Mono Blok 1 Kapılı/Prof. Line**
EF Vertical Refrigerators Mono Block 1 Door/Prof. Line



Dikey Buzdolapları 2 Kapılı/Prof. Line
Vertical Refrigerators 2 Door/Prof. Line

80-81

82-83

EF Dikey Buzdolapları 2 Kapılı/Prof. Line
EF Vertical Refrigerators 2 Door/Prof. Line



Dikey Buzdolapları 1 Kapılı/Prof. Line -25
Vertical Refrigerators 1 Door/Prof. Line -25

84-85

86-87

Dikey Buzdolapları 2 Kapılı/Prof. Line -25
Vertical Refrigerators 2 Door/Prof. Line -25



Yatay Buzdolapları - Mono Blok
Counter Type Refrigerators - Mono Block

88-89

90-91

Yatay Buzdolapları - Mono Blok
Counter Type Refrigerators - Mono Block



Yatay Buzdolapları - Mono Blok
Counter Type Refrigerators - Mono Block

92-93

94-95

Dondurucu / Buzdolabı Çekmece
Fridge / Freezer Drawer



Cihaz Altı Serisi
Chef Bases Series

96-97

98-99



Dikey Buzdolapları 1 Kapılı/Prof. Line Vertical Refrigerators 1 Door/Prof. Line



GN 2/1

FP

100€

Ayak Pedalı
Opsiyonu
Foot Pedal
Options

Option : 189 €

115 V / 60 Hz

26 Adet Raf
Kapasitesi.
4,5 cm Aralıklı.
26 Unit Shelf
Holder Capacity.
4,5 cm Spaced.

KF



89 €

Fanlı Kanopi
Canopy With Fan

VN9-M-LED



FRENOX
PROFESSIONAL REFRIGERATION

Professional Line Series

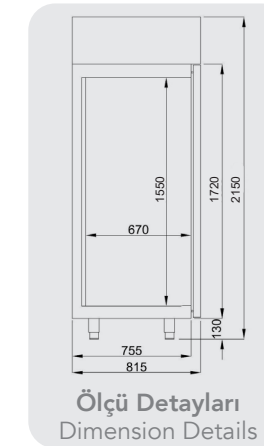

Ölçü Detayları
Dimension Details



85 mm İzolasyon
Kalınlığı
85 mm thickness



Ekstra Kuvvetli Dayanıklı
Fanlar Yüksek Hava Akışı
Strong Fans with maximum
air speed



Açılabilir Kanopiyle
Kolay Müdahale Olanağı
Front Cover Can be
Opened For Easy Access

Bilgi

- * Özel Kendinden Kalıplı Raf Sistemi
- * İç Derinlik: 65 Cm (GN 2/1 Kapasiteli)
- * 35-40 Kg/m³ Gazlı Çevre Dostu HCFC İçermeyen Poliüretan İzolasyon
- * Akıllı Defrost Sistemi
- * Otomatik Su Buharlaştırma Sistemi
- * Elektrikli Otomatik Defrost
- * Yüksekliği Ayarlanabilir Paslanmaz Ayaklar
- * Kapı Açıldığında Otomatik İç Aydınlatma
- * Özel, Kapı Menteşe Sistemi
- * Temizlenebilir ve Sökülebilir Manyetik Kapı Contası
- * Dış Ortam Sıcaklığı: + 43°C & % 65 Nem

Info

- * Special Self Shelving Design
- * Inside Depth: 65 Cm (GN 2/1 Capacity)
- * 35-40 Kg/m³ Ecology Friendly HCFC Free Polyurethane Insulation
- * Energy Saving Digital
- * Smart Defrost System
- * Automatic Water Evaporation System (Hot Gas)
- * Electrical Automatic Defrost
- * Stainless Steel Legs Adjustable For Height
- * Automatic Lighting Inside When Door is Open
- * Removable and Easy Cleaning Magnetic Gaskets
- * Ambient Temperature: + 43°C & % 65 Humidity

Kod Özellikleri Available Codes

Raf
Shelf 45 €

W
Tekerlekli / Wheels 90 €

T
Touch Dijital
Touch Digital 217 €

SE
Görüntü
Appearance 56 €

WP
Su Geçirmez Dijital
Water Proof Digital 137 €

-2
Yarım Kapı
Half Door 197 €

BT
Wi-Fi Dijital
Wi-Fi Digital 418 €

L
Sol Kapı
(Dikey)
Left Door
(Upright) 30 €

60_{hz}
220 V
60 hz 56 €

LED
LED Aydınlatma
LED Lighting 85 €

Model Models	İç Sıcaklık Temperature °C	Brüt Hacim Gross volume Lt.	Ölçüler Dimensions Cm.	Paket Ölçüsü Packing Dim. Cm.	Ağırlık Weight Kg.	Paslanmaz Özelliği Stainless Steel Type
	VN9-M	-2/+8	700	70x81x215	80x85x230	155 304
	VL9-M	-10/-22	700	70x81x215	80x85x230	159 304
	BN9-M	-2/+8	700	70x81x215	80x85x230	153 430
	BL9-M	-10/-22	700	70x81x215	80x85x230	160 430
	VN9-G-M	-2/+8	700	70x81x215	80x85x230	163 304
	VL9-G-M	-10/-22	700	70x81x215	80x85x230	170 304
	BN9-G-M	-2/+8	700	70x81x215	80x85x230	163 430
	BL9-G-M	-10/-22	700	70x81x215	80x85x230	170 430

İzolasyon Kalınlığı Insulation Thickness	Raf Adedi Shelf Unit	Soğutma Gazı Cooling Gas	Voltaj Voltage	Enerji Sınıfı Energy Rating	Kapı Adedi Door Unit	Fiyat Price €	Model Models	Fiyat Price
85 mm	3	R134A	220 V / 50 Hz	E	1	2.929 €	VN9-M-R290	2.902 €
85 mm	3	R404A	220 V / 50 Hz	E	1	3.584 €	VL9-M-R290	3.556 €
85 mm	3	R134A	220 V / 50 Hz	E	1	2.488 €	BN9-M-R290	2.462 €
85 mm	3	R404A	220 V / 50 Hz	E	1	2.980 €	BL9-M-R290	2.954 €
85 mm	3	R134A	220 V / 50 Hz	E	1	3.367 €	VN9-G-M-R290	3.339 €
85 mm	3	R404A	220 V / 50 Hz	E	1	4.237 €	VL9-G-M-R290	4.210 €
85 mm	3	R134A	220 V / 50 Hz	E	1	2.879 €	BN9-G-M-R290	2.852 €
85 mm	3	R404A	220 V / 50 Hz	E	1	3.688 €	BL9-G-R290	3.662 €

EF: Bu modellerde energy efficiency kondenser fanı kullanılmaktadır. / These models have energy efficiency condenser fans.

Dikey Buzdolapları 1 Kapılı/Prof. Line Vertical Refrigerators 1 Door/Prof. Line



GN 2/1

FP

100€

Ayak Pedali
Opsiyonu
Foot Pedal
Options



R290

Option : 189 €

115 V / 60 Hz

26 Adet Raf
Kapasitesi.
5 cm Aralıklarla.
26 Unit Shelf
Holder Capacity.
5 cm Spaced.



Professional Line Series

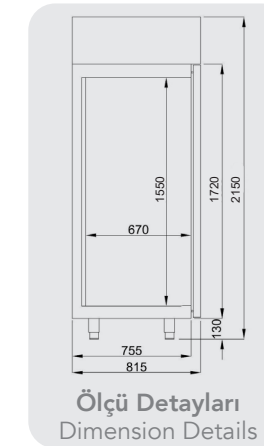

85 mm İzolasyon
Kalınlığı
85 mm thickness

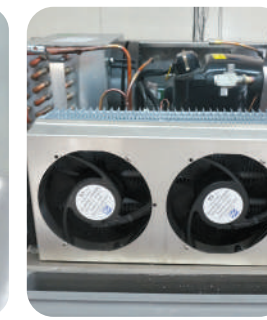

Ekstra Kuvvetli Dayanıklı
Fanlar Yüksek Hava Akışı
Strong Fans with maximum
air speed

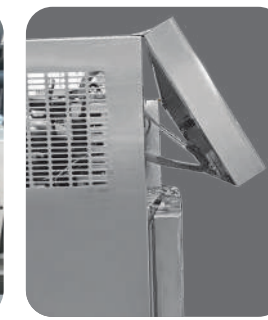

Açılabilir Kanopiyle
Kolay Müdahale Olanağı
Front Cover Can be
Opened For Easy Access

Bilgi

- * Özel Kendinden Kalıplı Raf Sistemi
- * İç Derinlik: 65 Cm (GN 2/1 Kapasiteli)
- * 35-40 Kg/m³ Gazlı Çevre Dostu HCFC İçermeyen Poliüretan İzolasyon
- * Akıllı Defrost Sistemi
- * Otomatik Su Buharlaştırma Sistemi
- * Elektrikli Otomatik Defrost
- * Yüksekliği Ayarlanabilir Paslanmaz Ayaklar
- * Kapı Açıldığında Otomatik İç Aydınlatma
- * Özel, Kapı Menteşe Sistemi
- * Temizlenebilir ve Sökülebilir Manyetik Kapı Contası
- * Dış Ortam Sıcaklığı: + 43°C & % 65 Nem

Info

- * Special Self Shelving Design
- * Inside Depth: 65 Cm (GN 2/1 Capacity)
- * 35-40 Kg/m³ Ecology Friendly HCFC Free Polyurethane Insulation
- * Energy Saving Digital
- * Smart Defrost System
- * Automatic Water Evaporation System (Hot Gas)
- * Electrical Automatic Defrost
- * Stainless Steel Legs Adjustable For Height
- * Automatic Lighting Inside When Door is Open
- * Removable and Easy Cleaning Magnetic Gaskets
- * Ambient Temperature: + 43°C & % 65 Humidity

Kod Özellikleri Available Codes

Raf Shelf 45 €

W Tekerlekli / Wheels 90 €

T Touch Dijital Touch Digital 217 €

SE Görüntü Appearance 56 €

WP Su Geçirmez Dijital Water Proof Digital 137 €

-2 Yarım Kapı Half Door 197 €

BT Wi-Fi Dijital Wi-Fi Digital 418 €

L Sol Kapı (Dikey) Left Door (Upright) 30 €

60_{hz} 220 V / 60 hz 56 €

LED LED Aydınlatma LED Lighting 85 €

İzolasyon Kalınlığı Insulation Thickness	Raf Adedi Shelf Unit	Soğutma Gazı Cooling Gas	Voltaj Voltage	Enerji Sınıfı Energy Rating	Kapı Adedi Door Unit	Model Models	Fiyat Price
85 mm	4	R290	220 V / 50 Hz	B	1	VN9-M-EF-R290	2.976 €
85 mm	4	R290	220 V / 50 Hz	D	1	VL9-M-EF-R290	3.630 €
85 mm	4	R290	220 V / 50 Hz	B	1	BN9-M-EF-R290	2.536 €
85 mm	4	R290	220 V / 50 Hz	D	1	BL9-M-EF-R290	3.028 €
85 mm	4	R290	220 V / 50 Hz	C	1	VN9-G-M-EF-R290	3.414 €
85 mm	4	R290	220 V / 50 Hz	E	1	VL9-G-M-EF-R290	4.284 €
85 mm	4	R290	220 V / 50 Hz	C	1	BN9-G-M-EF-R290	2.927 €
85 mm	4	R290	220 V / 50 Hz	E	1	BL9-G-M-EF-R290	3.736 €

Model Models	İç Sıcaklık Temperature °C	Brüt Hacim Gross volume Lt.	Ölçüler Dimensions Cm.	Paket Ölçüsü Packing Dim. Cm.	Ağırlık Weight Kg.	Paslanmaz Özelliği Stainless Steel Type
VN9-M-EF-R290	0/+8	700	70x81x215	80x85x230	155	304
VL9-M-EF-R290	-10/-22	700	70x81x215	80x85x230	159	304
BN9-M-EF-R290	0/+8	700	70x81x215	80x85x230	153	430
BL9-M-EF-R290	-10/-22	700	70x81x215	80x85x230	160	430
VN9-G-M-EF-R290	0/+8	700	70x81x215	80x85x230	163	304
VL9-G-M-EF-R290	-10/-22	700	70x81x215	80x85x230	170	304
BN9-G-M-EF-R290	0/+8	700	70x81x215	80x85x230	163	430
BL9-G-M-EF-R290	-10/-22	700	70x81x215	80x85x230	170	430

EF: Bu modellerde energy efficiency kondenser fanı kullanılmaktadır. / These models have energy efficiency condenser fans.

Dikey Buzdolapları 2 Kapılı/Prof. Line Vertical Refrigerators 2 Door/Prof. Line



GN 2/1

52 Adet Raf Kapasitesi.
5 cm Aralıklı.
52 Unit Shelf Holder Capacity.
5 cm Spaced.

FP

Ayak Pedal Opsiyonu
Foot Pedal Options

189€

Option : 189 €

115 V / 60 Hz

KF



89 €

Fanlı Kanopi
Canopy With Fan

Touch Dijital standart üretiminde mevcut değildir. Fiyat için yan sayfaya bakınız.

Touch Digital is not available in standart production. Check the options for the price.

VN18-M



FRENOX
PROFESSIONAL REFRIGERATION

Professional Line Series

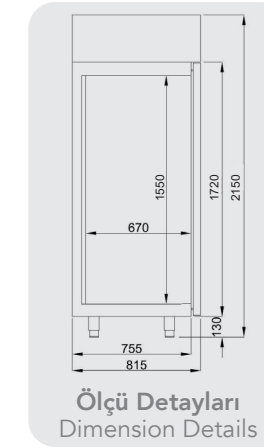

Ölçü Detayları
Dimension Details



85 mm İzolasyon Kalınlığı
85 mm thickness

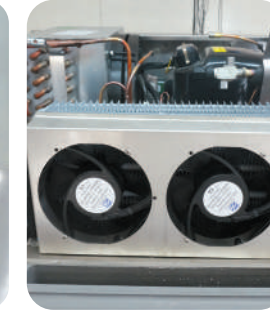

Ekstra Kuvvetli Dayanıklı Fanlar Yüksek Hava Akışı
Strong Fans with maximum air speed



Açılabilir Kanopiyle Kolay Müdahale Olanağı
Front Cover Can be Opened For Easy Access

Bilgi

- * Özel Kendinden Kalıplı Raf Sistemi
- * Mono Blok Soğutma Grubu
- * İç Derinlik: 65 Cm (GN 2/1 Kapasiteli)
- * 35-40 Kg/m³ Gazlı Çevre Dostu HCFC İçermeyen Poliüretan İzolasyon
- * Akıllı Defrost Sistemi
- * Otomatik Su Buharlaştırma Sistemi
- * Elektrikli Otomatik Defrost
- * Yüksekliği Ayarlanabilir Paslanmaz Ayaklar
- * Kapı Açıldığında Otomatik İç Aydınlatma
- * Özel, Kapı Mentеше Sistemi
- * Temizlenebilir ve Sökülebilir Manyetik Kapı Contası
- * Dış Ortam Sıcaklığı: + 43oC & % 65 Nem

Info

- * Special Self Shelving Design
- * Mono Block Cooling Group
- * Inside Depth: 65 Cm (GN 2/1 Capacity)
- * 35-40 Kg/m³ Ecology Friendly HCFC Free Polyurethane Insulation
- * Energy Saving Digital
- * Smart Defrost System
- * Automatic Water Evaporation System (Hot Gas)
- * Electrical Automatic Defrost
- * Stainless Steel Legs Adjustable For Height
- * Automatic Lighting Inside When Door is Open
- * Removable and Easy Cleaning Magnetic Gaskets
- * Ambient Temperature: + 43oC & % 65 Humidity

Kod Özellikleri Available Codes

Raf Shelf 45 €

W Tekerlekli / Wheels 90 €

T Touch Dijital Touch Digital 217 €

SE Görüntü Appearance 56 €

WP Su Geçirmez Dijital Water Proof Digital 137 €

-4 Yarım Kapı Half Door x2 394 €

BT Wi-Fi Dijital Wi-Fi Digital 418 €

60hz 220 V 60 hz 56 €

LED LED Aydınlatma LED Lighting 85 €

Model Models	İç Sıcaklık Temperature °C	Brüt Hacim Gross volume Lt.	Ölçüler Dimensions Cm.	Paket Ölçüsü Packing Dim. Cm.	Ağırlık Weight Kg.	Paslanmaz Özelliği Stainless Steel Type
	VN18-M	-2/+8	1400	140x81x215	150x85x230	304
	VL18-M	-10/-22	1400	140x81x215	150x85x230	304
	BN18-M	-2/+8	1400	140x81x215	150x85x230	430
	BL18-M	-10/-22	1400	140x81x215	150x85x230	430
	VN18-G-M	-2/+8	1400	140x81x215	150x85x230	304
	VL18-G-M	-10/-22	1400	140x81x215	150x85x230	304
	BN18-G-M	-2/+8	1400	140x81x215	150x85x230	430
	BL18-G-M	-10/-22	1400	140x81x215	150x85x230	430

İzolasyon Kalınlığı Insulation Thickness	Raf Adedi Shelf Unit	Soğutma Gazı Cooling Gas	Voltaj Voltage	Enerji Sınıfı Energy Rating	Kapı Adedi Door Unit	Fiyat Price €	Model Models	Fiyat Price
85 mm	6	R134A	220 V / 50 Hz	E	2	4.225 €	VN18-M-R290	4.197 €
85 mm	6	R404A	220 V / 50 Hz	E	2	5.094 €	VL18-M-R290	4.729 €
85 mm	6	R134A	220 V / 50 Hz	E	2	3.604 €	BN18-M-R290	3.578 €
85 mm	6	R404A	220 V / 50 Hz	E	2	4.731 €	BL18-M-R290	4.366 €
85 mm	6	R134A	220 V / 50 Hz	E	2	5.185 €	VN18-G-M-R290	5.157 €
85 mm	6	R404A	220 V / 50 Hz	E	2	6.647 €	VL18-G-M-R290	6.281 €
85 mm	6	R134A	220 V / 50 Hz	E	2	4.590 €	BN18-G-M-R290	4.564 €
85 mm	6	R404A	220 V / 50 Hz	E	2	6.210 €	BL18-G-M-R290	5.846 €

Dikey Buzdolapları 2 Kapılı/Prof. Line Vertical Refrigerators 2 Door/Prof. Line



R290

Option : 189 €

115 V / 60 Hz

52 Adet Raf Kapasitesi.
5 cm Aralıklı.
52 Unit Shelf Holder Capacity.
5 cm Spaced.

GN 2/1



89 €

Fanlı Kanopi
Canopy With Fan



189€

Ayak Pedalı
Opsiyonu
Foot Pedal
Options

VN18-M-EF-R290



FRENEX
PROFESSIONAL REFRIGERATION

Professional Line Series

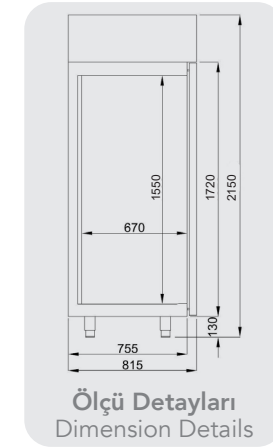

85 mm İzolasyon
Kalınlığı
85 mm thickness



Ekstra Kuvvetli Dayanıklı
Fanlar Yüksek Hava Akışı
Strong Fans with maximum
air speed



Açılabilir Kanopiyle
Kolay Müdahale Olanığı
Front Cover Can be
Opened For Easy Access

Bilgi

- * Özel Kendinden Kalıplı Raf Sistemi
- * Mono Blok Soğutma Grubu
- * İç Derinlik: 65 Cm (GN 2/1 Kapasiteli)
- * 35-40 Kg/m³ Gazlı Çevre Dostu HCFC İçermeyen Poliüretan İzolasyon
- * Akıllı Defrost Sistemi
- * Otomatik Su Buharlaştırma Sistemi
- * Elektrikli Otomatik Defrost
- * Yüksekliği Ayarlanabilir Paslanmaz Ayaklar
- * Kapı Açıldığında Otomatik İç Aydınlatma
- * Özel, Kapı Mentеше Sistemi
- * Temizlenebilir ve Sökülebilir Manyetik Kapı Contası
- * Dış Ortam Sıcaklığı: + 43oC & % 65 Nem

Info

- * Special Self Shelving Design
- * Mono Block Cooling Group
- * Inside Depth: 65 Cm (GN 2/1 Capacity)
- * 35-40 Kg/m³ Ecology Friendly HCFC Free Polyurethane Insulation
- * Energy Saving Digital
- * Smart Defrost System
- * Automatic Water Evaporation System (Hot Gas)
- * Electrical Automatic Defrost
- * Stainless Steel Legs Adjustable For Height
- * Automatic Lighting Inside When Door is Open
- * Removable and Easy Cleaning Magnetic Gaskets
- * Ambient Temperature: + 43oC & % 65 Humidity

Kod Özellikleri Available Codes

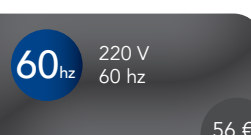
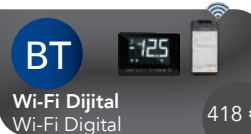
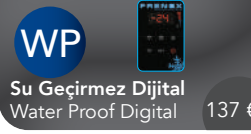
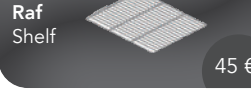

Model Models	İç Sıcaklık Temperature °C	Brüt Hacim Gross volume Lt.	Ölçüler Dimensions Cm.	Paket Ölçüsü Packing Dim. Cm.	Ağırlık Weight Kg.	Paslanmaz Özellikli Stainless Steel Type
VN18-M-EF-R290	0/+8	1400	140x81x215	150x85x230	265	304
VL18-M-EF-R290	-10/-22	1400	140x81x215	150x85x230	270	304
BN18-M-EF-R290	0/+8	1400	140x81x215	150x85x230	244	430
BL18-M-EF-R290	-10/-22	1400	140x81x215	150x85x230	250	430
VN18-G-M-EF-R290	0/+8	1400	140x81x215	150x85x230	280	304
VL18-G-M-EF-R290	-10/-22	1400	140x81x215	150x85x230	300	304
BN18-G-M-EF-R290	0/+8	1400	140x81x215	150x85x230	280	430
BL18-G-M-EF-R290	-10/-22	1400	140x81x215	150x85x230	300	430

İzolasyon Kalınlığı Insulation Thickness	Raf Adedi Shelf Unit	Soğutma Gazı Cooling Gas	Voltaj Voltage	Enerji Sınıfı Energy Rating	Kapı Adedi Door Unit	Model Models	Fiyat Price
85 mm	8	R290	220 V / 50 Hz	B	2	VN18-M-EF-R290	4.271 €
85 mm	8	R290	220 V / 50 Hz	D	2	VL18-M-EF-R290	4.803 €
85 mm	8	R290	220 V / 50 Hz	B	2	BN18-M-EF-R290	3.652 €
85 mm	8	R290	220 V / 50 Hz	D	2	BL18-M-EF-R290	4.441 €
85 mm	8	R290	220 V / 50 Hz	C	2	VN18-G-M-EF-R290	5.231 €
85 mm	8	R290	220 V / 50 Hz	E	2	VL18-G-M-EF-R290	6.356 €
85 mm	8	R290	220 V / 50 Hz	C	2	BN18-G-M-EF-R290	4.638 €
85 mm	8	R290	220 V / 50 Hz	E	2	BL18-G-M-EF-R290	5.920 €

EF: Bu modellerde energy efficiency kondenser fanı kullanılmaktadır. / These models have energy efficiency condenser fans.

Dikey Buzdolapları 1 Kapılı/Prof. Line -25

Vertical Refrigerators 1 Door/Prof. Line -25

GN 2/1

FP

100€

Ayak Pedalı
Opsiyonu
Foot Pedal
Options

Option : 189 €

-30°C
R404a

115 V / 60 Hz

-25°C
R290

26 Adet Raf
Kapasitesi.
5 cm Aralıklı.
26 Unit Shelf
Holder Capacity.
5 cm Spaced.

KF



89 €

Fanlı Kanopi
Canopy With Fan

VL10



FRENOX
PROFESSIONAL REFRIGERATION

Professional Line Series

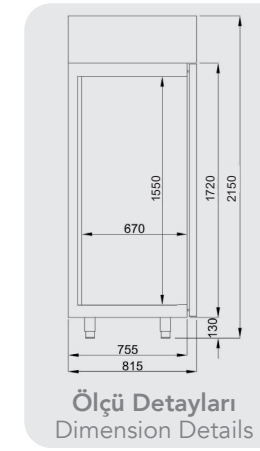

Ölçü Detayları
Dimension Details



85 mm İzolasyon
Kalınlığı
85 mm thickness

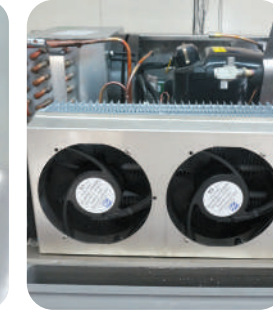

Ekstra Kuvvetli Dayanıklı
Fanlar Yüksek Hava Akışı
Strong Fans with maximum
air speed

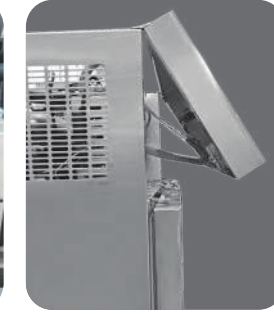

Açılabilir Kanopiyle
Kolay Müdahale Olanağı
Front Cover Can be
Opened For Easy Access

Bilgi

- * Özel Kendinden Kalıplı Raf Sistemi
- * İç Derinlik: 65 Cm (GN 2/1 Kapasiteli)
- * 35-40 Kg/m³ Gazlı Çevre Dostu HCFC İçermeyen Poliüretan İzolasyon
- * Akıllı Defrost Sistemi
- * Otomatik Su Buharlaştırma Sistemi
- * Elektrikli Otomatik Defrost
- * Yüksekliği Ayarlanabilir Paslanmaz Ayaklar
- * Kapı Açıldığında Otomatik İç Aydınlatma
- * Özel, Kapı Menteşe Sistemi
- * Temizlenebilir ve Sökülebilir Manyetik Kapı Contası
- * Dış Ortam Sıcaklığı: + 43°C & % 65 Nem

Info

- * Special Self Shelving Design
- * Inside Depth: 65 Cm (GN 2/1 Capacity)
- * 35-40 Kg/m³ Ecology Friendly HCFC Free Polyurethane Insulation
- * Energy Saving Digital
- * Smart Defrost System
- * Automatic Water Evaporation System (Hot Gas)
- * Electrical Automatic Defrost
- * Stainless Steel Legs Adjustable For Height
- * Automatic Lighting Inside When Door is Open
- * Removable and Easy Cleaning Magnetic Gaskets
- * Ambient Temperature: + 43°C & % 65 Humidity

Kod Özellikleri Available Codes

Raf
Shelf 45 €

W
Tekerlekli / Wheels 90 €

T
Touch Dijital
Touch Digital 217 €

SE
Görüntü
Appearance 56 €

WP
Su Geçirmez Dijital
Water Proof Digital 137 €

-2
Yarım Kapı
Half Door 197 €

BT
Wi-Fi Dijital
Wi-Fi Digital 418 €

L
Sol Kapı
(Dikey)
Left Door
(Upright) 30 €

60_{hz}
220 V
60 hz 56 €

LED
LED Aydınlatma
LED Lighting 85 €

Model Models	İç Sıcaklık Temperature °C	Brüt Hacim Gross volume Lt.	Ölçüler Dimensions Cm.	Paket Ölçüsü Packing Dim. Cm.	Ağırlık Weight Kg.	Paslanmaz Özelliği Stainless Steel Type	
	VN10	+8/-22	700	70x81x215	80x85x230	171	304
	VL10	-10/-30	700	70x81x215	80x85x230	175	304
	BN10	+8/-22	700	70x81x215	80x85x230	171	430
	BL10	-10/-30	700	70x81x215	80x85x230	175	430
	VN10-G	+8/-22	700	70x81x215	80x85x230	178	304
	VL10-G	-10/-30	700	70x81x215	80x85x230	185	304
	BN10-G	+8/-22	700	70x81x215	80x85x230	178	430
	BL10-G	-10/-30	700	70x81x215	80x85x230	185	430

İzolasyon Kalınlığı Insulation Thickness	Raf Adedi Shelf Unit	Soğutma Gazı Cooling Gas	Voltaj Voltage	Enerji Sınıfı Energy Rating	Kapı Adedi Door Unit	Fiyat Price €	Model Models	Fiyat Price
85 mm	3	R404A	220 V / 50 Hz	E	1	3.501 €	VN10-R290	3.473 €
85 mm	3	R404A	220 V / 50 Hz	E	1	4.062 €	VL10-R290	4.034 €
85 mm	3	R404A	220 V / 50 Hz	E	1	3.118 €	BN10-R290	3.092 €
85 mm	3	R404A	220 V / 50 Hz	E	1	3.646 €	BL10-R290	3.620 €
85 mm	3	R404A	220 V / 50 Hz	E	1	3.855 €	VN10-G-R290	3.827 €
85 mm	3	R404A	220 V / 50 Hz	E	1	4.875 €	VL10-G-R290	4.848 €
85 mm	3	R404A	220 V / 50 Hz	E	1	3.611 €	BN10-G-R290	3.584 €
85 mm	3	R404A	220 V / 50 Hz	E	1	4.420 €	BL10-G-R290	4.394 €

Dikey Buzdolapları 2 Kapılı/Prof. Line -25

Vertical Refrigerators 2 Door/Prof. Line -25

GN 2/1

FP

Ayak Pedalı
Opsiyonu
Foot Pedal
Options

189€

VL20

Option : 189 €

-30°C
R404a

115 V / 60 Hz

-25°C
R290

52 Adet Raf
Kapasitesi.
5 cm Aralıklı.
52 Unit Shelf
Holder Capacity.
5 cm Spaced.

KF



89 €

Fanlı Kanopi
Canopy With Fan



FRENOX
PROFESSIONAL REFRIGERATION

Professional Line Series

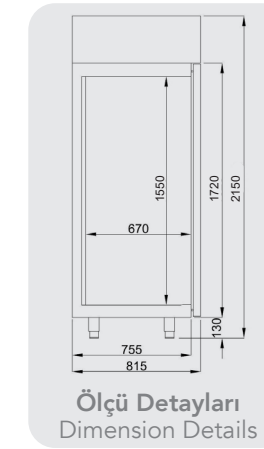

Ölçü Detayları
Dimension Details



85 mm İzolasyon
Kalınlığı
85 mm thickness

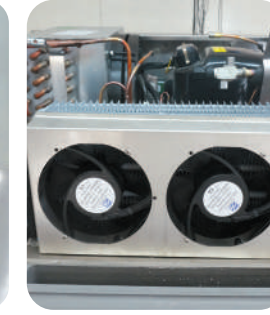

Ekstra Kuvvetli Dayanıklı
Fanlar Yüksek Hava Akışı
Strong Fans with maximum
air speed



Açılabilir Kanopiyle
Kolay Müdahale Olanağı
Front Cover Can be
Opened For Easy Access

Bilgi

- * Özel Kendinden Kalıplı Raf Sistemi
- * İç Derinlik: 65 Cm (GN 2/1 Kapasiteli)
- * 35-40 Kg/m³ Gazlı Çevre Dostu HCFC İçermeyen Poliüretan İzolasyon
- * Akıllı Defrost Sistemi
- * Otomatik Su Buharlaştırma Sistemi
- * Elektrikli Otomatik Defrost
- * Yüksekliği Ayarlanabilir Paslanmaz Ayaklar
- * Kapı Açıldığında Otomatik İç Aydınlatma
- * Özel, Kapı Menteşe Sistemi
- * Temizlenebilir ve Sökülebilir Manyetik Kapı Contası
- * Dış Ortam Sıcaklığı: + 43°C & % 65 Nem

Info

- * Special Self Shelving Design
- * Inside Depth: 65 Cm (GN 2/1 Capacity)
- * 35-40 Kg/m³ Ecology Friendly HCFC Free Polyurethane Insulation
- * Energy Saving Digital
- * Smart Defrost System
- * Automatic Water Evaporation System (Hot Gas)
- * Electrical Automatic Defrost
- * Stainless Steel Legs Adjustable For Height
- * Automatic Lighting Inside When Door is Open
- * Removable and Easy Cleaning Magnetic Gaskets
- * Ambient Temperature: + 43°C & % 65 Humidity

Kod Özellikleri Available Codes

Raf
Shelf 45 €

W
Tekerlekli / Wheels 90 €

T
Touch Dijital
Touch Digital 217 €

SE
Görüntü
Appearance 56 €

WP
Su Geçirmez Dijital
Water Proof Digital 137 €

-4
Yarım Kapı
Half Door x2 394 €

BT
Wi-Fi Dijital
Wi-Fi Digital 418 €

60hz
220 V
60 hz x2 56 €

LED
LED Aydınlatma
LED Lighting 85 €

Model Models	İç Sıcaklık Temperature °C	Brüt Hacim Gross volume Lt.	Ölçüler Dimensions Cm.	Paket Ölçüsü Packing Dim. Cm.	Ağırlık Weight Kg.	Paslanmaz Özellikli Stainless Steel Type
	VN20	+8/-22	1400	140x81x215	150x85x230	220 304
	VL20	-10/-30	1400	140x81x215	150x85x230	220 304
	BN20	+8/-22	1400	140x81x215	150x85x230	220 430
	BL20	-10/-30	1400	140x81x215	150x85x230	220 430
	VN20-G	+8/-22	1400	140x81x215	150x85x230	235 304
	VL20-G	-10/-30	1400	140x81x215	150x85x230	250 304
	BN20-G	+8/-22	1400	140x81x215	150x85x230	235 430
	BL20-G	-10/-30	1400	140x81x215	150x85x230	250 430

İzolasyon Kalınlığı Insulation Thickness	Raf Adedi Shelf Unit	Soğutma Gazı Cooling Gas	Voltaj Voltage	Enerji Sınıfı Energy Rating	Kapı Adedi Door Unit	Fiyat Price €	Model Models	Fiyat Price
85 mm	6	R404A	220 V / 50 Hz	E	2	5.939 €	VN20-R290	5.911 €
85 mm	6	R404A	220 V / 50 Hz	E	2	7.055 €	VL20-R290	7.027 €
85 mm	6	R404A	220 V / 50 Hz	E	2	5.519 €	BN20-R290	5.493 €
85 mm	6	R404A	220 V / 50 Hz	E	2	6.329 €	BL20-R290	6.303 €
85 mm	6	R404A	220 V / 50 Hz	E	2	6.973 €	VN20-G-R290	6.946 €
85 mm	6	R404A	220 V / 50 Hz	E	2	8.673 €	VL20-G-R290	8.646 €
85 mm	6	R404A	220 V / 50 Hz	E	2	6.505 €	BN20-G-R290	6.479 €
85 mm	6	R404A	220 V / 50 Hz	E	2	7.878 €	BL20-G-R290	7.852 €

Yatay Buzdolapları - Mono Blok

Counter Type Refrigerators - Mono Block

Option : 189 €

Özel
Kendinden
Kapanan
Çekmece
Special Self
Closing Drawer

115 V / 60 Hz

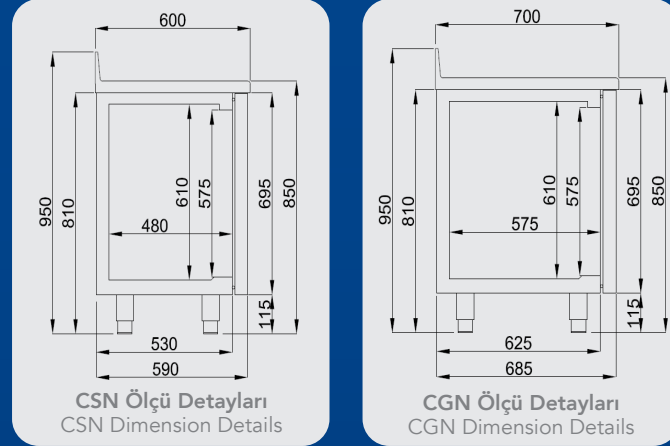

CSN Ölçü Detayları
CSN Dimension Details

CGN Ölçü Detayları
CGN Dimension Details



CGN2-M-A

Bu seride üst tabla yuvarlatılmıştır.
This series have curved work top



Monoblok
Soğutma Sistemi
Monoblock Cooling
Group



Standart Sırt Yüksekliği 10 cm'dir.
Standart Splash Back Height is 10 cm.



FRENOX
PROFESSIONAL REFRIGERATION

Professional Line Series

Çekmece Seçenekleri / Drawer Options

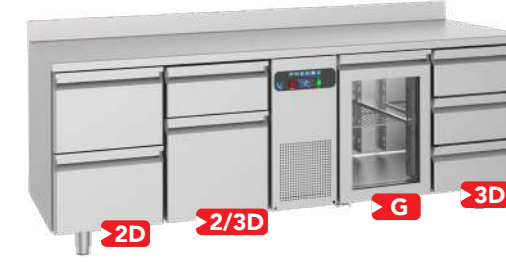

- 3D** 1/3 Çekmece - 1/3 Drawers 678 €
- 2D** 1/2 Çekmece - 1/2 Drawers 534 €
- G** Cam Kapı - Glass Door 234 €
- 2/3D** 2/3 Çekmece - 2/3 Drawers 588 €

Cam Kapı Sadece Pozitif Kapılar İçindir
Glass Door Option is Only Available for Positive Doors

Bilgi

- * İç Derinlik: 43 Cm / 53 Cm (GN 1/1 Kapasiteli)
- * 35-40 Kg/m³ Çevre Dostu HCFC İçermeyen Poliüretan İzolasyon
- * Dijital Kumanda Paneli
- * Elektrik Rezistanslı Otomatik Defrost
- * Özel Su Buharlaştırma Sistemi
- * Yüksekliği Ayarlanabilir Paslanmaz Ayaklar
- * Özel, Kapı Menteşe Sistemi
- * Temizlenebilir ve Sökülebilir Manyetik Kapı Contası
- * Dış Ortam Sıcaklığı: + 43°C & % 65 Nem

Info

- * Inside Depth: 43 Cm / 53 Cm (GN 1/1 Capacity)
- * 35-40 Kg/m³ Ecology Friendly HCFC Free Polyurethane Insulation
- * Digital Control Panel
- * Electrical Resistor Automatic Defrost
- * Special Water Evaporation
- * Stainless Steel Legs Adjustable For Height
- * Special Hinges and Door System
- * Removable and Easy Cleaning Magnetic Gaskets
- * Ambient Temperature: + 43°C %65 Humidity

Kod Özellikleri Available Codes

Raf ve Raf Kızağı
Shelf and Shelf Holder 49 €

MR 370 €
Mermer Üst Tabla
Marble Work Top

DZ 0 €
Düz Üst Tabla
Straight Work Top

F 304 : 155 €
430 : -80 €
Üst Tablasız
Without Work Top

GR 745 €
Granit Üst Tabla
Granite Work Top

T 217 €
Touch Dijital
Touch Digital

PL 709 €
Polietilen Üst Tabla
Polyethylene Work Top

60hz 56 €
220 V
60 hz

DKP 30 €
Dijital Koruma Plastiği
Digital Cover

W 90 €
Tekerlekli
Wheels

WP 137 €
Su Geçirmez Dijital
Water Proof Digital

K 70 €/Unt
Kilitli Kapı
With Lock

BT 418 €
Wi-Fi Dijital
Wi-Fi Digital

Model Models	İç Sıcaklık Temperature °C	Brüt Hacim Gross volume Lt.	Ölçüler Dimensions Cm.	Paket Ölçüsü Packing Dim. Cm.	Ağırlık Weight Kg.	Paslanmaz Özellikli Stainless Steel Type
	CSN2-M	-2/+8	250	130x60x85	140x70x105	130 304
	CGN2-M	-2/+8	281	130x70x85	140x80x105	136 304
	CSL2-M	-10/-20	250	130x60x85	140x70x105	140 304
	CGL2-M	-10/-20	281	130x70x85	140x80x105	145 304
	BSN2-M	-2/+8	250	130x60x85	140x70x105	130 430
	BGN2-M	-2/+8	281	130x70x85	140x80x105	136 430
	BSL2-M	-10/-20	250	130x60x85	140x70x105	140 430
	BGL2-M	-10/-20	281	130x70x85	140x80x105	145 430
	CSN2-M-G	-2/+8	250	130x60x85	140x70x105	135 304
	CGN2-M-G	-2/+8	281	130x70x85	140x80x105	141 304
	BSN2-M-G	-2/+8	250	130x60x85	140x70x105	135 430
	BGN2-M-G	-2/+8	281	130x70x85	140x80x105	141 430

İzolasyon Kalınlığı Insulation Thickness	Raf Adedi Shelf Unit	Soğutma Gazı Cooling Gas	Voltaj Voltage	Enerji Sınıfı Energy Rating	Fiyat Price €	Model Models	Fiyat Price
60 mm	2	R134A	220 V / 50 Hz	D	2.551 €	CSN2-M-R290	2.523 €
60 mm	2	R134A	220 V / 50 Hz	D	2.673 €	CGN2-M-R290	2.646 €
60 mm	2	R404A	220 V / 50 Hz	E	3.232 €	CSL2-M-R290	3.260 €
60 mm	2	R404A	220 V / 50 Hz	E	3.416 €	CGL2-M-R290	3.443 €
60 mm	2	R134A	220 V / 50 Hz	D	2.148 €	BSN2-M-R290	2.122 €
60 mm	2	R134A	220 V / 50 Hz	D	2.241 €	BGN2-M-R290	2.215 €
60 mm	2	R404A	220 V / 50 Hz	E	2.703 €	BSL2-M-R290	2.676 €
60 mm	2	R404A	220 V / 50 Hz	E	2.759 €	BGL2-M-R290	2.733 €
60 mm	2	R134A	220 V / 50 Hz	E	3.032 €	CSN2-M-G-R290	2.601 €
60 mm	2	R134A	220 V / 50 Hz	E	3.155 €	CGN2-M-G-R290	3.183 €
60 mm	2	R134A	220 V / 50 Hz	E	2.616 €	BSN2-M-G-R290	2.643 €
60 mm	2	R134A	220 V / 50 Hz	E	2.710 €	BGN2-M-G-R290	2.736 €

Yatay Buzdolapları - Mono Blok

Counter Type Refrigerators - Mono Block

Option : 189 €

115 V / 60 Hz

Özel
Kendinden
Kapanan
Çekmece
Special Self
Closing Drawer

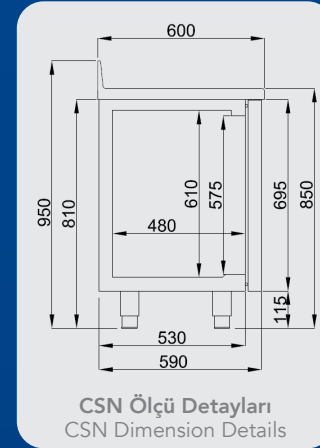
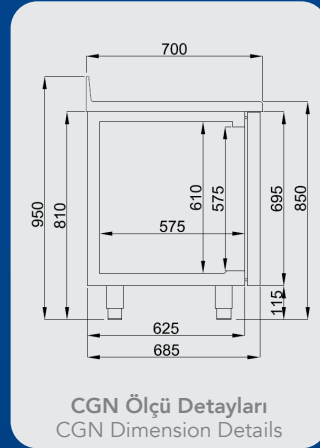

CGN3-M-A

Bu seride üst tabla yuvarlatılmıştır.
This series have curved work top

Monoblok
Soğutma Sistemi
Monoblock Cooling
Group



Standart Sırt Yüksekliği 10 cm'dir.
Standart Splash Back Height is 10 cm.



FRENOX
PROFESSIONAL REFRIGERATION

Professional Line Series

Çekmece Seçenekleri / Drawer Options

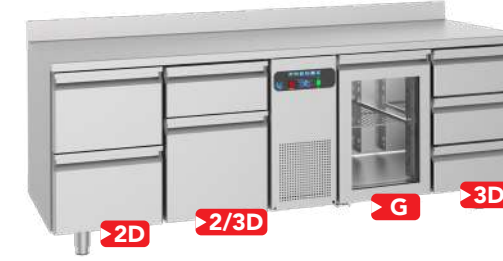

- 3D** 1/3 Çekmece - 1/3 Drawers 678 €
- 2D** 1/2 Çekmece - 1/2 Drawers 534 €
- G** Cam Kapı - Glass Door 234 €
- 2/3D** 2/3 Çekmece - 2/3 Drawers 588 €

Cam Kapı Sadece Pozitif Kapılar İçindir
Glass Door Option is Only Available for Positive Doors

Bilgi

- * İç Derinlik: 43 Cm / 53 Cm (GN 1/1 Kapasiteli)
- * 35-40 Kg/m³ Çevre Dostu HCFC İçermeyen Poliüretan İzolasyon
- * Energy Saving Digital
- * Akıllı Defrost Sistemi
- * Elektrik Rezistanslı Otomatik Defrost
- * Özel Su Buharlaştırma Sistemi
- * Yüksekliği Ayarlanabilir Paslanmaz Ayaklar
- * Özel, Kapı Mentеше Sistemi
- * Temizlenebilir ve Sökülebilir Manyetik Kapı Contası
- * Dış Ortam Sıcaklığı: + 43°C & % 65 Nem

Info

- * Inside Depth: 43 Cm / 53 Cm (GN 1/1 Capacity)
- * 35-40 Kg/m³ Ecology Friendly HCFC Free Polyurethane Insulation
- * Energy Saving Digital
- * Smart Defrost System
- * Electrical Resistor Automatic Defrost
- * Special Water Evaporation
- * Stainless Steel Legs Adjustable For Height
- * Special Hinges and Door System
- * Removable and Easy Cleaning Magnetic Gaskets
- * Ambient Temperature: + 43°C %65 Humidity

Kod Özellikleri Available Codes

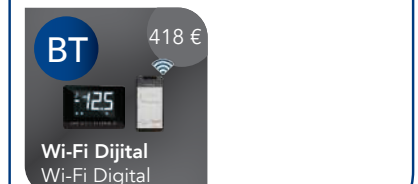
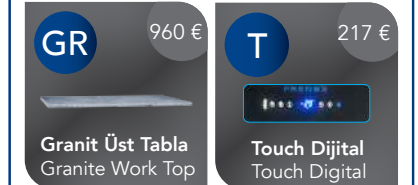

Model Models	İç Sıcaklık Temperature °C	Brüt Hacim Gross volume Lt.	Ölçüler Dimensions Cm.	Paket Ölçüsü Packing Dim. Cm.	Ağırlık Weight Kg.	Paslanmaz Özelligi Stainless Steel Type
	CSN3-M	-2/+8	400	178,5x60x85	188,5x70x105	160 304
	CGN3-M	-2/+8	474	178,5x70x85	188,5x80x105	170 304
	CSL3-M	-10/-20	400	178,5x60x85	188,5x70x105	170 304
	CGL3-M	-10/-20	474	178,5x70x85	188,5x80x105	175 304
	BSN3-M	-2/+8	400	178,5x60x85	188,5x70x105	160 430
	BGN3-M	-2/+8	474	178,5x70x85	188,5x80x105	170 430
	BSL3-M	-10/-20	400	178,5x60x85	188,5x70x105	170 430
	BGL3-M	-10/-20	474	178,5x70x85	188,5x80x105	175 430
	CSN3-M-G	-2/+8	400	178,5x60x85	188,5x70x105	168 304
	CGN3-M-G	-2/+8	474	178,5x70x85	188,5x80x105	178 304
	BSN3-M-G	-2/+8	400	178,5x60x85	188,5x70x105	168 430
	BGN3-M-G	-2/+8	474	178,5x70x85	188,5x80x105	178 430

İzolasyon Kalınlığı Insulation Thickness	Raf Adedi Shelf Unit	Soğutma Gazı Cooling Gas	Voltaj Voltage	Enerji Sınıfı Energy Rating	Fiyat Price €	Model Models	Fiyat Price
60 mm	3	R134A	220 V - 50 Hz	D	3.063 €	CSN3-M-R290	3.036 €
60 mm	3	R134A	220 V - 50 Hz	D	3.153 €	CGN3-M-R290	3.125 €
60 mm	3	R404A	220 V - 50 Hz	E	3.944 €	CSL3-M-R290	3.917 €
60 mm	3	R404A	220 V - 50 Hz	E	3.989 €	CGL3-M-R290	3.961 €
60 mm	3	R134A	220 V - 50 Hz	D	2.514 €	BSN3-M-R290	2.488 €
60 mm	3	R134A	220 V - 50 Hz	D	2.585 €	BGN3-M-R290	2.559 €
60 mm	3	R404A	220 V - 50 Hz	E	3.266 €	BSL3-M-R290	3.239 €
60 mm	3	R404A	220 V - 50 Hz	E	3.379 €	BGL3-M-R290	3.353 €
60 mm	3	R134A	220 V - 50 Hz	E	3.700 €	CSN3-M-G-R290	3.672 €
60 mm	3	R134A	220 V - 50 Hz	E	3.788 €	CGN3-M-G-R290	3.761 €
60 mm	3	R134A	220 V - 50 Hz	E	3.125 €	BSN3-M-G-R290	3.099 €
60 mm	3	R134A	220 V - 50 Hz	E	3.137 €	BGN3-M-G-R290	3.110 €

EF: Bu modellerde energy efficiency kondenser fanı kullanılmaktadır. / These models have energy efficiency condenser fans.

Yatay Buzdolapları - Mono Blok

Counter Type Refrigerators - Mono Block

Option : 189 €

115 V / 60 Hz

Monoblok Soğutma Sistemi
Monoblock Cooling Group

10 Min.
MONOBLOCK REPLACEMENT

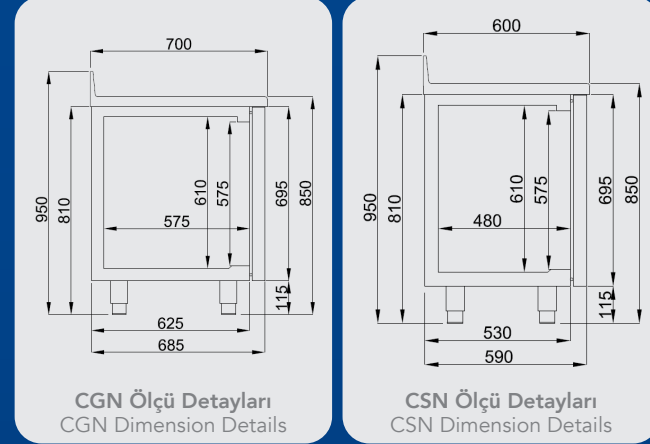

CGN Ölçü Detayları
CGN Dimension Details

CSN Ölçü Detayları
CSN Dimension Details

Özel Kendinden Kapanan Çekmece
Special Self Closing Drawer



CGN4-M-A

Bu seride üst tabla yuvarlatılmıştır.
This series have curved work top

Standart Sırt Yüksekliği 10 cm'dir.
Standart Splash Back Height is 10 cm.



FRENOX
PROFESSIONAL REFRIGERATION

Professional Line Series

Çekmece Seçenekleri / Drawer Options

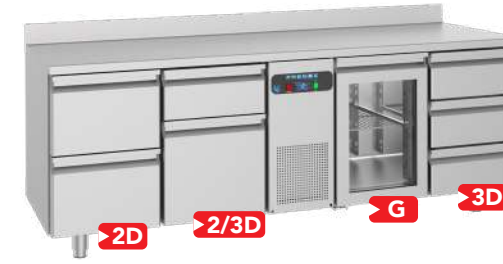

- 3D** 1/3 Çekmece - 1/3 Drawers 678 €
- 2D** 1/2 Çekmece - 1/2 Drawers 534 €
- G** Cam Kapı - Glass Door 234 €
- 2/3D** 2/3 Çekmece - 2/3 Drawers 588 €

Cam Kapı Sadece Pozitif Kapılar İçindir
Glass Door Option is Only Available for Positive Doors

Bilgi

- * İç Derinlik: 43 Cm / 53 Cm (GN 1/1 Kapasiteli)
- * 35-40 Kg/m³ Çevre Dostu HCFC İçermeyen Poliüretan İzolasyon
- * Dijital Kumanda Paneli
- * Elektrik Rezistanslı Otomatik Defrost
- * Özel Su Buharlaştırma Sistemi
- * Yüksekliği Ayarlanabilir Paslanmaz Ayaklar
- * Özel, Kapı Menteşe Sistemi
- * Temizlenebilir ve Sökülebilir Manyetik Kapı Contası
- * Dış Ortam Sıcaklığı: + 43°C & % 65 Nem

Info

- * Inside Depth: 43 Cm / 53 Cm (GN 1/1 Capacity)
- * 35-40 Kg/m³ Ecology Friendly HCFC Free Polyurethane Insulation
- * Digital Control Panel
- * Electrical Resistor Automatic Defrost
- * Special Water Evaporation
- * Stainless Steel Legs Adjustable For Height
- * Special Hinges and Door System
- * Removable and Easy Cleaning Magnetic Gaskets
- * Ambient Temperature: + 43°C %65 Humidity

Kod Özellikleri Available Codes

Raf ve Raf Kızağı Shelf and Shelf Holder 49 €
MR 628 €
Mermer Üst Tabla Marble Work Top

DZ 0 €
Düz Üst Tabla Straight Work Top
F 304 : -194 €
430 : -94 €
Üst Tablasız Without Work Top

GR 1249 €
Granit Üst Tabla Granite Work Top
T 217 €
Touch Dijital Touch Digital

PL 1197 €
Polietilen Üst Tabla Polyethylene Work Top
60_{hz} 56 €
220 V
60 Hz

DKP 30 €
Dijital Koruma Plastiği Digital Cover
W 90 €
Tekerlekli Wheels

WP 137 €
Su Geçirmez Dijital Water Proof Digital
K 70 €/Unt
Kilitli Kapı With Lock

BT 418 €
Wi-Fi Dijital Wi-Fi Digital

Model Models	İç Sıcaklık Temperature °C	Brüt Hacim Gross volume Lt.	Ölçüler Dimensions Cm.	Paket Ölçüsü Packing Dim. Cm.	Ağırlık Weight Kg.	Paslanmaz Özellikli Steel Type	
	CSN4-M	-2/+8	550	227x60x85	237x70x100	195	304
	CGN4-M	-2/+8	632	227x70x85	237x80x100	205	304
	CSL4-M	-10/-20	550	227x60x85	237x70x100	205	304
	CGL4-M	-10/-20	632	227x70x85	237x80x100	210	304
	BSN4-M	-2/+8	550	227x60x85	237x70x100	195	430
	BGN4-M	-2/+8	632	227x70x85	237x80x100	205	430
	BSL4-M	-10/-20	550	227x60x85	237x70x100	205	430
	BGL4-M	-10/-20	632	227x70x85	237x80x100	210	430
	CSN4-M-G	-2/+8	550	227x60x85	237x70x100	205	304
	CGN4-M-G	-2/+8	632	227x70x85	237x80x100	215	304
	BSN4-M-G	-2/+8	550	227x60x85	237x70x100	205	430
	BGN4-M-G	-2/+8	632	227x70x85	237x80x100	215	430

İzolasyon Kalınlığı Insulation Thickness	Raf Adedi Shelf Unit	Soğutma Gazı Cooling Gas	Voltaj Voltage	Enerji Sınıfı Energy Rating	Fiyat Price €
60 mm	4	R134A	220 V / 50 Hz	D	3.722 €
60 mm	4	R134A	220 V / 50 Hz	D	3.870 €
60 mm	4	R404A	220 V / 50 Hz	E	5.348 €
60 mm	4	R404A	220 V / 50 Hz	E	5.633 €
60 mm	4	R134A	220 V / 50 Hz	D	3.055 €
60 mm	4	R134A	220 V / 50 Hz	D	3.110 €
60 mm	4	R404A	220 V / 50 Hz	E	4.585 €
60 mm	4	R404A	220 V / 50 Hz	E	4.870 €
60 mm	4	R134A	220 V / 50 Hz	E	4.609 €
60 mm	4	R134A	220 V / 50 Hz	E	4.756 €
60 mm	4	R134A	220 V / 50 Hz	E	3.900 €
60 mm	4	R134A	220 V / 50 Hz	E	3.956 €

Model Models	Fiyat Price
CSN4-M-R290	3.694 €
CGN4-M-R290	3.842 €
CSL4-M-R290	5.320 €
CGL4-M-R290	5.430 €
BSN4-M-R290	3.029 €
BGN4-M-R290	3.084 €
BSL4-M-R290	4.558 €
BGL4-M-R290	4.669 €
CSN4-M-G-R290	4.581 €
CGN4-M-G-R290	4.729 €
BSN4-M-G-R290	3.874 €
BGN4-M-G-R290	3.929 €

EF: Bu modellerde energy efficiency kondenser fanı kullanılmaktadır. / These models have energy efficiency condenser fans.

Dondurucu / Buzdolabı Çekmece

Fridge / Freezer Drawer

GN 2/1 KAPASİTELİ
GN 2/1 CAPACITY

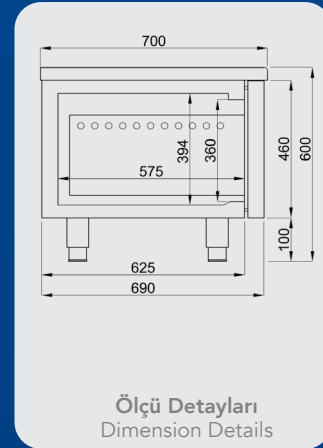

Option : 189 €

115 V / 60 Hz



CEK1

Gastronom kaplar fiyata dahil değildir.

Gastronom cups are not included in the price.



Professional Line Series

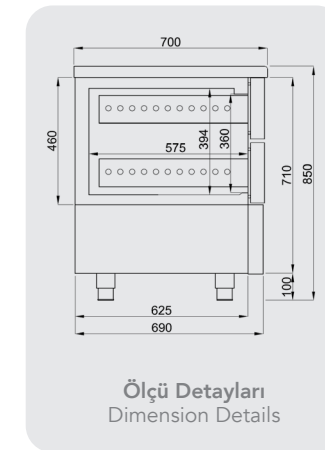

Bilgi

- * İç Derinlik: GN 2/1 Kapasiteli
- * 35-40 Kg/m³ Çevre Dostu HCFC İçermeyen Poliüretan İzolasyon
- * Dijital Kumanda Paneli
- * Elektrik Rezistanslı Otomatik Defrost
- * Özel Su Buharlaştırma Sistemi
- * Yüksekliği Ayarlanabilir Paslanmaz Ayaklar
- * Özel, Kapı Menteşe Sistemi
- * Temizlenebilir ve Sökülebilir Manyetik Kapı Contası
- * Dış Ortam Sıcaklığı: + 43°C & % 65 Nem



Info

- * Inside GN 2/1 Capacity
- * 35-40 Kg/m³ Ecology Friendly HCFC Free Polyurethane Insulation
- * Digital Control Panel
- * Electrical Resistor Automatic Defrost
- * Special Water Evaporation
- * Stainless Steel Legs Adjustable For Height
- * Special Door and Hinge Systems
- * Removable and Easy Cleaning Magnetic Gaskets
- * Ambient Temperature: + 43°C %65 Humidity

Kod Özellikleri

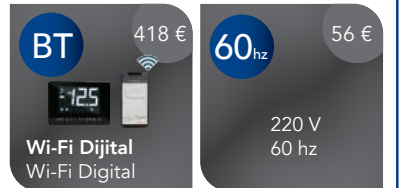
Available Codes



Model Models	İç Sıcaklık Temperature °C	GN Kapasite GN Capacity Lt.	Ölçüler Dimensions Cm.	Paket Ölçüsü Packing Dim. Cm.	Ağırlık Weight Kg.	Paslanmaz Özelliği Stainless Steel Type
	-20/+8	2 Ad. GN 2/1x100	93x70x85	103x80x100	115	304
	-20/+8	1 Ad. GN 2/1x150	120x70x60	130x80x75	105	304

İzolasyon Kalınlığı Insulation Thickness	Raf Adedi Shelf Unit	Soğutma Gazı Cooling Gas	Voltaj Voltage	Fiyat Price €
50 mm		R290	220 V / 50 Hz	4.309 €
50 mm		R290	220 V / 50 Hz	4.171 €

Cihaz Altı Serisi

Chef Bases Series

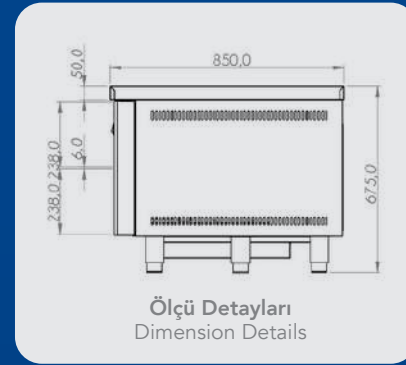

Ölçü Detayları
Dimension Details

Option : 189 €



CBN180

GN 2/1
KAPASİTELİ
GN 2/1
CAPACITY

115 V / 60 Hz

Gastronom kaplar fiyata dahil değildir.

Gastronom cups are not included in the price.



Professional Line Series



Bilgi

- * İç Derinlik: GN 2/1 Kapasiteli
- * 35-40 Kg/m³ Çevre Dostu HCFC İçermeyen Poliüretan İzolasyon
- * Dijital Kumanda Paneli
- * Elektrik Rezistanslı Otomatik Defrost
- * Özel Su Buharlaştırma Sistemi
- * Yüksekliği Ayarlanabilir Paslanmaz Ayaklar
- * Özel, Kapı Menteşe Sistemi
- * Temizlenebilir ve Sökülebilir Manyetik Kapı Contası
- * Dış Ortam Sıcaklığı: + 43°C & % 65 Nem

Info

- * Inside GN 2/1 Capacity
- * 35-40 Kg/m³ Ecology Friendly HCFC Free Polyurethane Insulation
- * Digital Control Panel
- * Electrical Resistor Automatic Defrost
- * Special Water Evaporation
- * Stainless Steel Legs Adjustable For Height
- * Special Door and Hinge Systems
- * Removable and Easy Cleaning Magnetic Gaskets
- * Ambient Temperature: + 43°C %65 Humidity

Kod Özellikleri

Available Codes

MR

609 €



Mermer Üst Tabla
Marble Work Top

GR

1213 €



Granit Üst Tabla
Granite Work Top

DKP

30 €



Dijital Koruma Plastiği
Digital Cover

PL

1162 €



Polietilen Üst Tabla
Polyethylene Work Top

BT

418 €



Wi-Fi Dijital
Wi-Fi Digital

WP

137 €



Su Geçirmez Dijital
Water Proof Digital

W

90 €



Tekerlekli
Wheels

60_{hz}

56 €

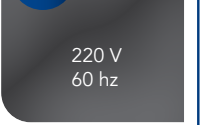

220 V
60 Hz

Model Models	İç Sıcaklık Temperature °C	Brüt Hacim Gross Volume Lt.	Ölçüler Dimensions Cm.	Paket Ölçüsü Packing Dim. Cm.	Ağırlık Weight Kg.	Paslanmaz Özelliği Stainless Steel Type
CBN120	-2 / 8	178	120 x 84 x 67.5	123 x 90 x 75	84	304
CBN160	-2 / 8	260	160 x 84 x 67.5	163 x 90 x 75	99.5	304
CBN180	-2 / 8	340	180 x 84 x 67.5	183 x 90 x 75	115	304
CBN200	-2 / 8	380	200 x 84 x 67.5	203 x 90 x 75	122.75	304

İzolasyon Kalınlığı Insulation Thickness	Çekmece Adedi Drawer Unit	Soğutma Gazı Cooling Gas	Voltaj Voltage	Fiyat Price €
50 mm	2	R290	220 V / 50 Hz	2.498 €
50 mm	2	R290	220 V / 50 Hz	2.755 €
50 mm	4	R290	220 V / 50 Hz	3.517 €
50 mm	4	R290	220 V / 50 Hz	3.590 €

Cihaz Altı Serisi - Derin Dondurucu

Chef Bases Series - Freezer

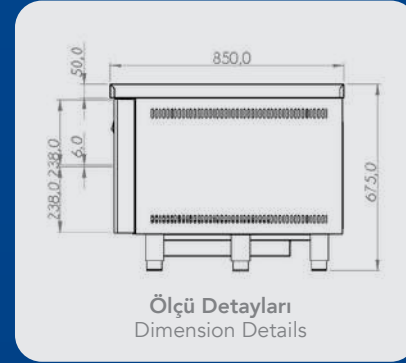

Option : 189 €



CBL180

GN 2/1 KAPASİTELİ
GN 2/1 CAPACITY

115 V / 60 Hz

Gastronom kaplar fiyata dahil değildir.

Gastronom cups are not included in the price.



Professional Line Series



Bilgi

- * İç Derinlik: GN 2/1 Kapasiteli
- * 35-40 Kg/m³ Çevre Dostu HCFC İçermeyen Poliüretan İzolasyon
- * Dijital Kumanda Paneli
- * Elektrik Rezistanslı Otomatik Defrost
- * Özel Su Buharlaştırma Sistemi
- * Yüksekliği Ayarlanabilir Paslanmaz Ayaklar
- * Özel, Kapı Mentеше Sistemi
- * Temizlenebilir ve Sökülebilir Manyetik Kapı Contası
- * Dış Ortam Sıcaklığı: + 43°C & % 65 Nem

Info

- * Inside GN 2/1 Capacity
- * 35-40 Kg/m³ Ecology Friendly HCFC Free Polyurethane Insulation
- * Digital Control Panel
- * Electrical Resistor Automatic Defrost
- * Special Water Evaporation
- * Stainless Steel Legs Adjustable For Height
- * Special Door and Hinge Systems
- * Removable and Easy Cleaning Magnetic Gaskets
- * Ambient Temperature: + 43°C %65 Humidity

Kod Özellikleri

Available Codes

MR

609 €



GR

1213 €



DKP

30 €



PL

1162 €



BT

418 €



WP

137 €



W

90 €



60_{hz}

56 €



Model Models	İç Sıcaklık Temperature °C	Brüt Hacim Gross Volume Lt.	Ölçüler Dimensions Cm.	Paket Ölçüsü Packing Dim. Cm.	Ağırlık Weight Kg.	Paslanmaz Özelliği Stainless Steel Type
CBL120	-10 / -22	178	120 x 84 x 67.5	123 x 90 x 75	88	304
CBL160	-10 / -22	260	160 x 84 x 67.5	163 x 90 x 75	103.5	304
CBL180	-10 / -22	340	180 x 84 x 67.5	183 x 90 x 75	119	304
CBL200	-10 / -22	380	200 x 84 x 67.5	203 x 90 x 75	126.75	304

İzolasyon Kalınlığı Insulation Thickness	Çekmece Adedi Drawer Unit	Soğutma Gazı Cooling Gas	Voltaj Voltage	Fiyat Price €
50 mm	2	R290	220 V / 50 Hz	2.781 €
50 mm	2	R290	220 V / 50 Hz	3.116 €
50 mm	4	R290	220 V / 50 Hz	3.893 €
50 mm	4	R290	220 V / 50 Hz	3.976 €



Blast Freezer / Chiller
Blast Freezer Refrigerators

102-103

104-105

Blast Freezer - Pişir / Sakla
Blast Freezer - Cook / Chill



Panel Blast Freezer / Chiller
Panel Blast Freezer Refrigerators

106-107

108-109

Blast Freezer Chiller Oda
Blast Freezer / Chiller Room



Geniş Kapılı Blast Freezer Oda
Blast Freezer Room With Wide Door

110-111



Blast Freezer /
Chiller

Blast Freezer / Chiller

Blast Freezer Refrigerators



Blast Freezer / Chiller

Ürünlerin şoklama soğukluğu -40°C dir.
The operation temperature is -40°C.



VBL15

Maksimum +90°C ürün konulabilir.
Maximum +90°C product temperature.

40x60 Tepsisi Kapasiteli
40x60 Tray Capacity

GN 1/1

Ürünlerin şoklama soğukluğu -35°C dir.
The operation temperature is -35°C.



VBL5

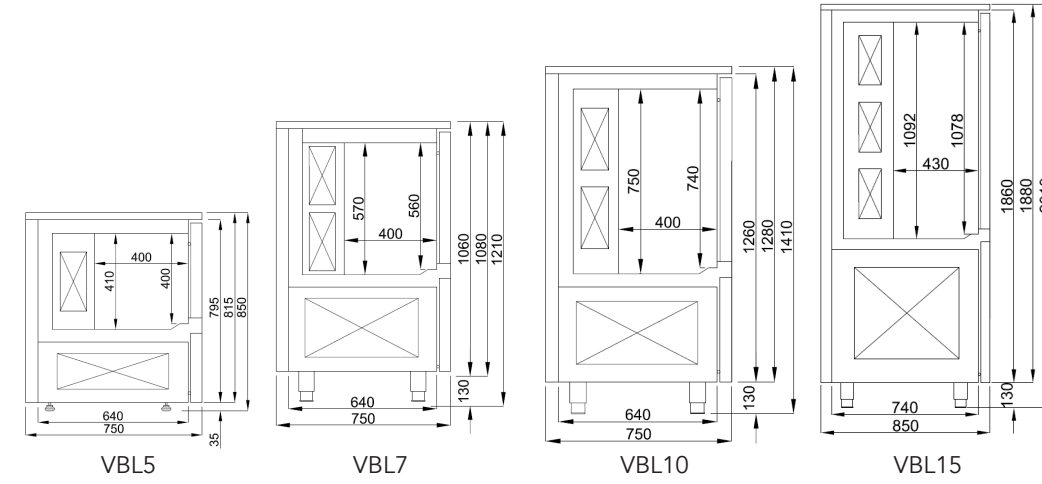

Bilgi

- * GN 1/1 veya 40x60 Tepsisi Kapasiteli
- * 35-40 Kg/m³ Çevre Dostu HCFC İçermeyen Poliüretan İzolasyon
- * Dijital Kumanda Paneli
- * Sıcak Gazlı Otomatik Defrost
- * Özel Su Buharlaştırma Sistemi
- * Yüksekliği Ayarlanabilir Paslanmaz Ayaklar
- * Özel, Kapı Mentеше Sistemi
- * Temizlenebilir ve Sökülebilir Manyetik Kapı Contası

Info

- * GN 1/1 or 40x60 Tray Capacity
- * 35-40 Kg/m³ Ecology Friendly HCFC Free Polyurethane Insulation
- * Digital Control Panel
- * Automatic Defrost With Hot Gas
- * Special Water Evaporation
- * Stainless Steel Legs Adjustable For Height
- * Special Door and Hinge Systems
- * Removable and Easy Cleaning Magnetic Gaskets

Kod Özellikleri Available Codes



Model Models	Soğutma Sıcaklığı Chilling Temperature °C	Dondurma Sıcaklığı Freezing Temperature °C	Dış Hava Sıcaklığı Ambient temperature °C	Tepsi Kapasitesi Trays Capacity GN 1/1 60x40	Soğutma Kapasitesi 90 Dakika Chilling Capacity 90 Minutes Kg.	Dondurma Kapasitesi 270 Dakika Freezing Capacity 270 Minutes Kg.	GN 1/1 60x40 Yükseklik Height mm
VBL15	+90/+3	+90/-18	+38	15	35	30	50
VBL10	+90/+3	+90/-18	+38	10	30	25	50
VBL7	+90/+3	+90/-18	+38	7	25	20	50
VBL5	+90/+3	+90/-18	+38	5	20	15	50

Ölçüler Dimensions Cm.	Paket Ölçüsü Packing Dim. Cm.	Ağırlık Weight Kg.	Paslanmaz Özelligi Stainless Steel Type	İzolasyon Kalınlığı Insulation Thickness mm	Soğutma Gazı Cooling Gas	Voltaj Voltage	Kapı Adedi Door Unit	Model Models	Fiyat Price
80x85x201	90x95x211	263	304	60 mm	R290	220 V / 50 Hz / 1 Ph	1	R452A Soğutma Gazı R452A Cooling Gas	VBL15-R290 10.054 €
80x75x141	90x85x151	201	304	60 mm	R290	220 V / 50 Hz / 1 Ph	1		VBL10-R290 5.584 €
80x75x121	90x85x131	173	304	60 mm	R290	220 V / 50 Hz / 1 Ph	1		VBL7-R290 4.475 €
80x75x85	90x85x95	161	304	60 mm	R290	220 V / 50 Hz / 1 Ph	1		VBL5-R290 3.990 €

* 60 hz ürünlerde R404A soğutma gazı kullanılmaktadır. / In 60 Hz products, R404 refrigerant gas is used.

Blast Freezer - Pişir / Sakla

Blast Freezer - Cook / Chill



VBL5-F

Ürünlerin
şoklama soğukluğu
-35°C dir.
The operation
temperature is
-35°C.

40x60
Tepsi Kapasiteli
40x60
Tray Capacity

GN 1/1

Maksimum
+90°C ürün
konulabilir.
Maximum
+90°C product
temperature.

VBL5-F modeli üzerine doğrudan fırın koyulacak şekilde tasarlanmıştır.
VBL5-F Model is designed to be placed under the oven directly.
*Fırın ürüne dahil değildir. / Oven is not included.

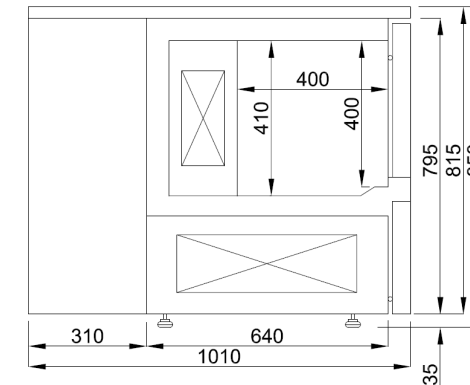

VB5-F



VBL5-F

Bilgi

- * GN 1/1 veya 40x60 Tepsi Kapasiteli
- * 35-40 Kg/m³ Çevre Dostu HCFC İçermeyen Poliüretan İzolasyon
- * Dijital Kumanda Paneli
- * Elektrik Rezistanslı Otomatik Defrost
- * Özel Su Buharlaştırma Sistemi
- * Yüksekliği Ayarlanabilir Paslanmaz Ayaklar
- * Özel, Kapı Mentеше Sistemi
- * Temizlenebilir ve Sökülebilir Manyetik Kapı Contası

Info

- * GN 1/1 or 40x60 Tray Capacity
- * 35-40 Kg/m³ Ecology Friendly HCFC Free Polyurethane Insulation
- * Digital Control Panel
- * Electrical Resistor Automatic Defrost
- * Special Water Evaporation
- * Stainless Steel Legs Adjustable For Height
- * Special Door and Hinge Systems
- * Removable and Easy Cleaning Magnetic Gaskets

Kod Özellikleri

Available Codes

W
Tekerlekli / Wheels 90 €

İğne Probu 450 €

60hz 220 V 60 hz 56 €

Model Models	Soğutma Sıcaklığı Chilling Temperature °C	Dondurma Sıcaklığı Freezing Temperature °C	Dış Hava Sıcaklığı Ambient temperature °C	Tepsi Kapasitesi Trays Capacity GN 1/1 60x40	Soğutma Kapasitesi 90 Dakika Chilling Capacity 90 Minutes Kg.	Dondurma Kapasitesi 270 Dakika Freezing Capacity 270 Minutes Kg.	GN 1/1 60x40 Yükseklik Height mm
 VBL5-F	+90/+3	+90/-18	+38	5	20	12	50

Ölçüler Dimensions Cm.	Paket Ölçüsü Packing Dim. Cm.	Ağırlık Weight Kg.	Paslanmaz Özelliği Stainless Steel Type	İzolasyon Kalınlığı Insulation Thickness mm	Soğutma Gazı Cooling Gas	Voltaj Voltage	Kapı Adedi Door Unit	Fiyat Price €	Model Models R452A Soğutma Gazı R452A Cooling Gas	Fiyat Price €
90x101x91	100x111x101	145	304	60 mm	R404	220 V / 50 Hz / 1 Ph	1	5.332 €	VBL5-F-R290	5.179 €

Panel Blast Freezer / Chiller

Panel Blast Freezer Refrigerators



FRENOX
PROFESSIONAL REFRIGERATION

Blast Freezer / Chiller



VBL10-2/1

TB 1.855 €

Ürünlerin
şoklama soğukluğu
-35°C dir.
The operation
temperature is
-35°C.



GN 2/1

Maksimum
+90°C ürün
konulabilir.
Maximum
+90°C product
temperature.

- * Özel Program Yazabilme
- * Ekstra Prop (Max. 3 Adet)
- * Special Program Ability
- * Extra Prop (Max. 3 Unt)



Bilgi

- * GN 2/1
- * 35-40 Kg/m³ Çevre Dostu HCFC İçermeyen Poliüretan İzolasyon
- * Dijital Kumanda Paneli
- * Sıcak Gazlı Otomatik Defrost
- * Özel Su Buharlaştırma Sistemi
- * Yüksekliği Ayarlanabilir Paslanmaz Ayaklar
- * Özel, Kapı Mentеше Sistemi
- * Temizlenebilir ve Sökülebilir Manyetik Kapı Contası

Info

- * GN 2/1
- * 35-40 Kg/m³ Ecology Friendly HCFC Free Polyurethane Insulation
- * Digital Control Panel
- * Automatic Defrost With Hot Gas
- * Special Water Evaporation
- * Stainless Steel Legs Adjustable For Height
- * Special Door and Hinge Systems
- * Removable and Easy Cleaning Magnetic Gaskets

Kod Özellikleri

Available Codes



Model Models	Soğutma Sıcaklığı Chilling Temperature °C	Dondurma Sıcaklığı Freezing Temperature °C	Dış Hava Sıcaklığı Ambient temperature °C	Tepsi Kapasitesi Trays Capacity GN 2/1	Soğutma Kapasitesi 90 Dakika Chilling Capacity 90 Minutes Kg.	Dondurma Kapasitesi 270 Dakika Freezing Capacity 270 Minutes Kg.	GN 2/1 Yükseklik Height mm
 VBL10-2/1	+90/+3	+90/-18	+38	10	35	30	50

Ölçüler Dimensions Cm.	Paket Ölçüsü Packing Dim. Cm.	Ağırlık Weight Kg.	Paslanmaz Özelliği Stainless Steel Type	İzolasyon Kalınlığı Insulation Thickness mm	Soğutma Gazı Cooling Gas	Voltaj Voltage	Kapı Adedi Door Unit	Fiyat Price €
100x86x201	120x100x230	263	304	80 mm	R290	220 V / 50 Hz / 1 Ph	1	11.882 €

Blast Freezer Chiller Oda

Blast Freezer / Chiller Room



Blast Freezer / Chiller



VBL20

* Tepsi taşıma arabası fiyata dahil değildir.
* Trolley is not included in the price.

Ürünlerin şoklama soğukluğu -35°C dir.
The operation temperature is -35°C.

Maksimum +90°C ürün konulabilir.
Maximum +90°C product temperature.

40x60 Tepsi Kapasiteli
40x60 Tray Capacity
GN 2/1



Programlanabilir kontrol paneli
Programmable control panel



* Özel Programlanabilir HACCP Dijital
* Special HACCP Controller with programs



VBL40



VBL40

Kod Özellikleri
Available Codes

L Sol Kapı (Dikey) / Left Door (Upright) 478 €

Bilgi

- * GN 2/1 veya 40x60 Tepsi Kapasiteli
- * 35-40 Kg/m³ Çevre Dostu HCFC İçermeyen Poliüretan İzolasyon
- * Özel HACCP Dijital
- * Otomatik Defrost
- * Özel Su Buharlaştırma Sistemi
- * Özel, Kapı Mentеше Sistemi
- * Temizlenebilir ve Sökülebilir Manyetik Kapı Contası
- * Paslanmaz Rampa
- * İç ve Dış 304 Paslanmaz Gövdesi
- * Farklı Ürünler İçin Kaydedilebilir Program Özeliği
- * Split Soğutma Grubu



Info

- * GN 2/1 or 40x60 Tray Capacity
- * 35-40 Kg/m³ Ecology Friendly HCFC Free Polyurethane Insulation
- * Special HACCP Controller
- * Automatic Defrost
- * Special Water Evaporation
- * Special Door and Hinge Systems
- * Removable and Easy Cleaning Magnetic Gaskets
- * Stainless Steel Ramp
- * 304 Stainless Steel Inside and Outside
- * Special Programing System for Several Products
- * Split Cooling Unit

Soğutma Grubu / Cooling Units	Ölçüler / Dimensions / cm
VBL40-SG	185x90x110
VBL20-SG	147x76x80



VBL20-SG

Model / Models	Soğutma Sıcaklığı / Chilling Temperature / °C	Dondurma Sıcaklığı / Freezing Temperature / °C	Dış Hava Sıcaklığı / Ambient temperature / °C	Tepsi Kapasitesi / Trays Capacity / GN 2/1	Soğutma Kapasitesi / Chilling Capacity / 90 Dakika / 90 Minutes / Kg.	Dondurma Kapasitesi / Freezing Capacity / 270 Dakika / 270 Minutes / Kg.	GN 1/1 60x40 Yükseklik / Height / mm	
	VBL40	+90/+3	+90/-18	+38	2 Araba / 40 Ad. GN 2/1 / 2 Trolleys / 40 Pcs. GN 2/1	200	180	50
	VBL20	+90/+3	+90/-18	+38	1 Araba / 20 Ad. GN 2/1 / 1 Trolleys / 20 Pcs. GN 2/1	140	120	50

Ölçüler / Dimensions / Cm.	Paslanmaz Özelligi / Stainless Steel Type	İzolasyon Kalınlığı / Insulation Thickness	Soğutma Gazı / Cooling Gas	Voltaj / Voltage / Volt / Ph / Hz	Kapı Adedi / Door Unit	Fiyat / Price / €	Soğutma Grubu / Cooling Unit	Fiyat / Price / €
170x171x214	304	120 mm	R404A	380-420 / 3 / 50 / 440-480 / 3 / 60	1	24.514 €	VBL40-SG	14.482 €
170x126x214	304	120 mm	R404A	380-420 / 3 / 50 / 440-480 / 3 / 60	1	20.685 €	VBL20-SG	11.821 €

* Soğutma grubu maksimum 5 metre uzaklığına göre hesaplanmıştır / Cooling groups can be installed max. 5 metres away from the refrigerator.
* Soğutma grubu montajı fiyata dahil değildir. / Cooling groups assembly is not included in the price.

Geniş Kapılı Blast Freezer Oda

Blast Freezer Room With Wide Door

40x60
Tepsi Kapasiteli
40x60
Tray Capacity

GN 2/1

Net Kapı Geçiş Ölçüsü: 85x176.5 cm
Net Door Passage Dimensions: 85x176.5 cm

Araba Ölçüsü: 78x102x174 cm
Trolley Dimensions: 78x102x174 cm

Ürünlerin
şoklama soğukluğu
-35°C dir.
The operation
temperature is
-35°C.



- * Özel Programlanabilir HACCP Dijital
- * Special HACCP Controller with programs

Maksimum
+90°C ürün
konulabilir.
Maximum
+90°C product
temperature.

VBL20-GK

- * Tepsi taşıma arabası fiyata dahil değildir.
- * Trolley is not included in the price.



FRENOX
PROFESSIONAL REFRIGERATION

Blast Freezer / Chiller



VBL40-GK



VBL40-GK

Kod Özellikleri
Available Codes

L Sol Kapı
(Dikey)
Left Door
(Upright) 478 €

Bilgi

- * GN 2/1 veya 40x60 Tepsi Kapasiteli
- * 35-40 Kg/m³ Çevre Dostu HCFC İçermeyen Poliüretan İzolasyon
- * Özel HACCP Dijital
- * Otomatik Defrost
- * Özel Su Buharlaştırma Sistemi
- * Özel, Kapı Mentşe Sistemi
- * Temizlenebilir ve Sökülebilir Manyetik Kapı Contası
- * Paslanmaz Rampa
- * İç ve Dış 304 Paslanmaz Gövdesi
- * Farklı Ürünler İçin Kaydedilebilir Program Özeliği
- * Split Soğutma Grubu

Info

- * GN 2/1 or 40x60 Tray Capacity
- * 35-40 Kg/m³ Ecology Friendly HCFC Free Polyurethane Insulation
- * Special HACCP Controller
- * Automatic Defrost
- * Special Water Evaporation
- * Special Door and Hinge Systems
- * Removable and Easy Cleaning Magnetic Gaskets
- * Stainless Steel Ramp
- * 304 Stainless Steel Inside and Outside
- * Special Programming System for Several Products
- * Split Cooling Unit

Soğutma Grubu Cooling Units	Ölçüler Dimensions cm
VBL40-SG	185x90x110
VBL20-SG	147x76x80



VBL20-SG

Model Models	Soğutma Sıcaklığı Chilling Temperature °C	Dondurma Sıcaklığı Freezing Temperature °C	Dış Hava Sıcaklığı Ambient temperature °C	Tepsi Kapasitesi Trays Capacity GN 2/1	Soğutma Kapasitesi 90 Dakika Chilling Capacity 90 Minutes Kg.	Dondurma Kapasitesi 270 Dakika Freezing Capacity 270 Minutes Kg.	GN 1/1 60x40 Yükseklik Height mm
 VBL20-GK	+90/+3	+90/-18	+38	1 Araba Rasyonel Tepsili GN 2/1 1 Trolleys Rational Tray GN 2/1	140	120	50

* Soğutma grubu montajı fiyata dahil değildir. / Cooling groups assembly is not included in the price.

Ölçüler Dimensions Cm.	Paslanmaz Özelliği Stainless Steel Type	İzolasyon Kalınlığı Insulation Thickness	Soğutma Gazı Cooling Gas	Voltaj Voltage Volt / Ph / Hz	Kapı Adedi Door Unit	Fiyat Price €	Soğutma Grubu Cooling Unit	Fiyat Price €
182 x 126 x 214	304	120 mm	R404A	380-420 / 3 / 50 440-480 / 3 / 60	1	22.097 €	VBL20-SG	11.821 €

* Soğutma grubu maksimum 5 metre uzaklığına göre hesaplanmıştır / Cooling groups can be installed max. 5 metres away from the refrigerator.



A Sınıfı Dik Buzdolabı 1 Kapılı / INV
A Class Vertical Refrigerator 1 Door / INV

114-115

114-115

C Sınıfı Dik Derin Dondurucu 1 Kapı / INV
C Class Vertical Freezer 1 Door / INV



A Sınıfı Dik Buzdolabı 2 Kapılı / INV
A Class Vertical Refrigerator 2 Doors / INV

116-117

116-117

C Sınıfı Dik Derin Dondurucu 2 Kapı / INV
C Class Vertical Freezer 2 Doors / INV



Yatay Buzdolapları - Mono Blok
Counter Type Refrigerators - Mono Block

118-119

120-121

Yatay Buzdolapları - Mono Blok
Counter Type Refrigerators - Mono Block



Yatay Buzdolapları - Mono Blok
Counter Type Refrigerators - Mono Block

122-123



Dikey Buzdolapları Mono Blok 1 Kapılı/Prof. Line Vertical Refrigerators Mono Block 1 Door/Prof. Line

GN 2/1

FP

Ayak Pedalı
Opsiyonu
Foot Pedal
Options

101€

VN9-M-EF-INV-R290

Daha Sessiz Çalışma ve
Daha Yüksek Enerji
Verimliliği

Dijital Inverter
Teknolojisi
Digital Inverter
Technology

26 Adet Raf
Kapasitesi.
5 cm Aralıklarla.
26 Unit Shelf
Holder Capacity.
5 cm Spaced.

KF
89 €
Fanlı Kanopi
Canopy With Fan

10
Min.
MONOBLOCK
REPLACEMENT

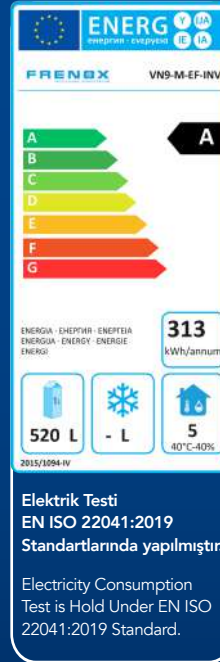

FRENEX
PROFESSIONAL REFRIGERATION

Energy Efficiency Line Series

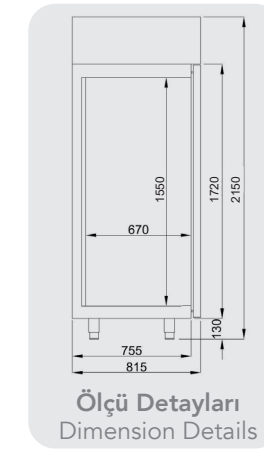

Ölçü Detayları
Dimension Details

*Üst düzey enerji verimliliği ile birlikte daha sessiz ve uzun ömürlü performansın tadını çıkarın. Dijital İnverter Kompresör, soğutma ihtiyacına duyarlı bir şekilde hızını otomatik olarak ayarlar, bu da daha az enerji tüketimiyle birlikte daha sessiz bir çalışma sağlar.



Ekstra Kuvvetli Dayanıklı Fanlar Yüksek Hava Akışı
Strong Fans with maximum air speed



Açılabilir Kanopiyle Kolay Müdahale Olanakları
Front Cover Can be Opened For Easy Access

Kod Özellikleri
Available Codes

Raf Shelf 45 €

W Tekerlekli / Wheels 90 €

T Touch Dijital Touch Digital 217 €

SE Görüntü Appearance 56 €

WP Su Geçirmez Dijital Water Proof Digital 137 €

-2 Yarım Kapı Half Door 197 €

BT Wi-Fi Dijital Wi-Fi Digital 418 €

L Sol Kapı (Dikey) Left Door (Upright) 30 €

Bilgi

- * Özel Kendinden Kalıplı Raf Sistemi
- * İç Derinlik: 65 Cm (GN 2/1 Kapasiteli)
- * 35-40 Kg/m³ Gazlı Çevre Dostu HCFC İçermeyen Poliüretan İzolasyon
- * Akıllı Defrost Sistemi
- * Otomatik Su Buharlaştırma Sistemi
- * Elektrikli Otomatik Defrost
- * Yüksekliği Ayarlanabilir Paslanmaz Ayaklar
- * Kapı Açıldığında Otomatik İç Aydınlatma
- * Özel, Kapı Menteşe Sistemi
- * Temizlenebilir ve Sökülebilir Manyetik Kapı Contası
- * Dış Ortam Sıcaklığı: + 43°C & % 65 Nem

Info

- * Special Self Shelving Design
- * Inside Depth: 65 Cm (GN 2/1 Capacity)
- * 35-40 Kg/m³ Ecology Friendly HCFC Free Polyurethane Insulation
- * Energy Saving Digital
- * Smart Defrost System
- * Automatic Water Evaporation System (Hot Gas)
- * Electrical Automatic Defrost
- * Stainless Steel Legs Adjustable For Height
- * Automatic Lighting Inside When Door is Open
- * Removable and Easy Cleaning Magnetic Gaskets
- * Ambient Temperature: + 43°C & % 65 Humidity

Model Models	İç Sıcaklık Temperature °C	Brüt Hacim Gross volume Lt.	Ölçüler Dimensions Cm.	Paket Ölçüsü Packing Dim. Cm.	Ağırlık Weight Kg.	Paslanmaz Özellikli Stainless Steel Type
VN9-M-EF-INV	0/+8	700	70x81x215	80x85x230	155	304
VL9-M-EF-INV	-10/-22	700	70x81x215	80x85x230	159	304
BN9-M-EF-INV	0/+8	700	70x81x215	80x85x230	153	430
BL9-M-EF-INV	-10/-22	700	70x81x215	80x85x230	160	430
VN9-G-M-EF-INV	0/+8	700	70x81x215	80x85x230	163	304
VL9-G-M-EF-INV	-10/-22	700	70x81x215	80x85x230	170	304
BN9-G-M-EF-INV	0/+8	700	70x81x215	80x85x230	163	430
BL9-G-M-EF-INV	-10/-22	700	70x81x215	80x85x230	170	430

İzolasyon Kalınlığı Insulation Thickness	Raf Adedi Shelf Unit	Soğutma Gazı Cooling Gas	Voltaj Voltage	Enerji Sınıfı Energy Rating	Kapı Adedi Door Unit	Model Models	Fiyat Price
85 mm	4	R290	220 V / 50 Hz	A	1	VN9-M-EF-INV	3.183 €
85 mm	4	R290	220 V / 50 Hz	C	1	VL9-M-EF-INV	3.395 €
85 mm	4	R290	220 V / 50 Hz	A	1	BN9-M-EF-INV	2.758 €
85 mm	4	R290	220 V / 50 Hz	C	1	BL9-M-EF-INV	3.077 €
85 mm	4	R290	220 V / 50 Hz	B	1	VN9-G-M-EF-INV	3.448 €
85 mm	4	R290	220 V / 50 Hz	D	1	VL9-G-M-EF-INV	3.925 €
85 mm	4	R290	220 V / 50 Hz	B	1	BN9-G-M-EF-INV	3.024 €
85 mm	4	R290	220 V / 50 Hz	D	1	BL9-G-M-EF-INV	3.607 €

EF: Bu modellerde energy efficiency kondenser fanı kullanılmaktadır. / These models have energy efficiency condenser fans.

Dikey Buzdolapları 2 Kapılı/Prof. Line Vertical Refrigerators 2 Door/Prof. Line



Daha Sessiz Çalışma ve
Daha Yüksek Enerji
Verimliliği

Dijital Inverter
Teknolojisi
Digital Inverter
Technology

52 Adet Raf
Kapasitesi.
5 cm Aralıklı.
52 Unit Shelf
Holder Capacity.
5 cm Spaced.

GN 2/1



VN18-M-EF-INV-R290



Energy Efficiency Line Series

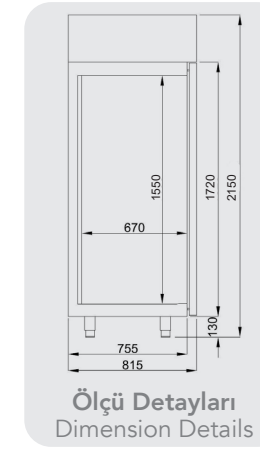

*Üst düzey enerji verimliliği ile birlikte daha sessiz ve uzun ömürlü performansın tadını çıkarın. Dijital İnverter Kompresör, soğutma ihtiyacına duyarlı bir şekilde hızını otomatik olarak ayarlar, bu da daha az enerji tüketimiyle birlikte daha sessiz bir çalışma sağlar.



Ekstra Kuvvetli Dayanıklı Fanlar Yüksek Hava Akışı
Strong Fans with maximum air speed

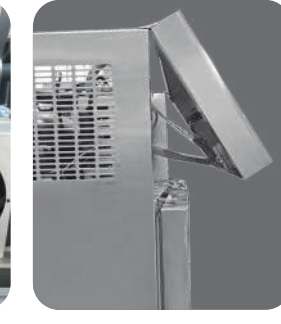

Açılabilir Kanopiyle Kolay Müdahale Olanağı
Front Cover Can be Opened For Easy Access

Bilgi

- * Özel Kendinden Kalıplı Raf Sistemi
- * Mono Blok Soğutma Grubu
- * İç Derinlik: 65 Cm (GN 2/1 Kapasiteli)
- * 35-40 Kg/m³ Gazlı Çevre Dostu HCFC İçermeyen Poliüretan İzolasyon
- * Akıllı Defrost Sistemi
- * Otomatik Su Buharlaştırma Sistemi
- * Elektrikli Otomatik Defrost
- * Yüksekliği Ayarlanabilir Paslanmaz Ayaklar
- * Kapı Açıldığında Otomatik İç Aydınlatma
- * Özel, Kapı Mentеше Sistemi
- * Temizlenebilir ve Sökülebilir Manyetik Kapı Contası
- * Dış Ortam Sıcaklığı: + 43oC & % 65 Nem

Info

- * Special Self Shelving Design
- * Mono Block Cooling Group
- * Inside Depth: 65 Cm (GN 2/1 Capacity)
- * 35-40 Kg/m³ Ecology Friendly HCFC Free Polyurethane Insulation
- * Energy Saving Digital
- * Smart Defrost System
- * Automatic Water Evaporation System (Hot Gas)
- * Electrical Automatic Defrost
- * Stainless Steel Legs Adjustable For Height
- * Automatic Lighting Inside When Door is Open
- * Removable and Easy Cleaning Magnetic Gaskets
- * Ambient Temperature: + 43oC & % 65 Humidity

Kod Özellikleri Available Codes

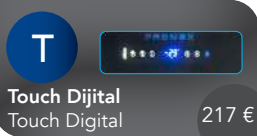
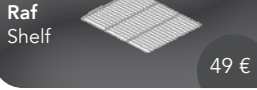

Model Models	İç Sıcaklık Temperature °C	Brüt Hacim Gross volume Lt.	Ölçüler Dimensions Cm.	Paket Ölçüsü Packing Dim. Cm.	Ağırlık Weight Kg.	Paslanmaz Özellizi Stainless Steel Type
VN18-M-EF-INV-R290	0/+8	1400	140x81x215	150x85x230	265	304
VL18-M-EF-INV-R290	-10/-25	1400	140x81x215	150x85x230	270	304
BN18-M-EF-INV-R290	0/+8	1400	140x81x215	150x85x230	244	430
BL18-M-EF-INV-R290	-10/-25	1400	140x81x215	150x85x230	250	430
VN18-G-M-EF-INV-R290	0/+8	1400	140x81x215	150x85x230	280	304
VL18-G-M-EF-INV-R290	-10/-25	1400	140x81x215	150x85x230	300	304
BN18-G-M-EF-INV-R290	0/+8	1400	140x81x215	150x85x230	280	430
BL18-G-M-EF-INV-R290	-10/-25	1400	140x81x215	150x85x230	300	430

İzolasyon Kalınlığı Insulation Thickness	Raf Adedi Shelf Unit	Soğutma Gazı Cooling Gas	Voltaj Voltage	Enerji Sınıfı Energy Rating	Kapı Adedi Door Unit	Model Models	Fiyat Price
85 mm	8	R290	220 V / 50 Hz	A	2	VN18-M-EF-INV-R290	4.031 €
85 mm	8	R290	220 V / 50 Hz	C	2	VL18-M-EF-INV-R290	4.774 €
85 mm	8	R290	220 V / 50 Hz	A	2	BN18-M-EF-INV-R290	3.607 €
85 mm	8	R290	220 V / 50 Hz	C	2	BL18-M-EF-INV-R290	4.562 €
85 mm	8	R290	220 V / 50 Hz	C	2	VN18-G-M-EF-INV-R290	4.562 €
85 mm	8	R290	220 V / 50 Hz	E	2	VL18-G-M-EF-INV-R290	5.835 €
85 mm	8	R290	220 V / 50 Hz	C	2	BN18-G-M-EF-INV-R290	4.138 €
85 mm	8	R290	220 V / 50 Hz	E	2	BL18-G-M-EF-INV-R290	5.623 €

EF: Bu modellerde energy efficiency kondenser fanı kullanılmaktadır. / These models have energy efficiency condenser fans.

Yatay Buzdolapları - Mono Blok

Counter Type Refrigerators - Mono Block



Energy Efficiency Line Series

Option : 189 €

115 V / 60 Hz

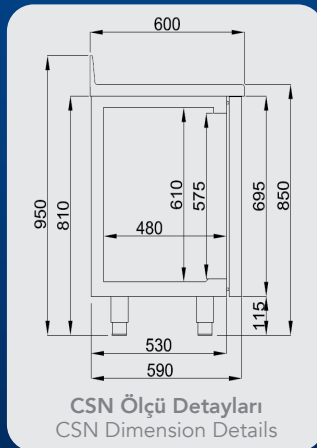
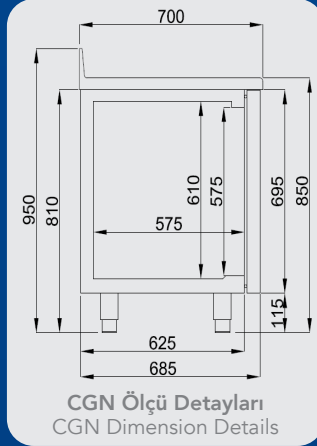
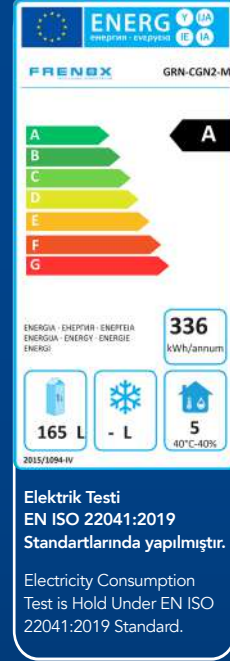

Özel Kendinden Kapanan Çekmece
Special Self Closing Drawer



Bu seride üst tabla yuvarlatılmıştır.
This series have curved work top

Standart Sırt Yüksekliği 10 cm'dir.
Standart Splash Back Height is 10 cm.

GRN-CGN2-M-A

Çekmece Seçenekleri / Drawer Options

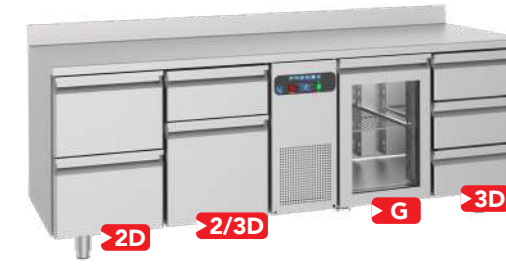

- 3D** 1/3 Çekmece - 1/3 Drawers 678 €
- 2D** 1/2 Çekmece - 1/2 Drawers 534 €
- G** Cam Kapı - Glass Door 234 €
- 2/3D** 2/3 Çekmece - 2/3 Drawers 588 €

Cam Kapı Sadece Pozitif Kapılar İçindir
Glass Door Option is Only Available for Positive Doors

Bilgi

- * İç Derinlik : 43 Cm / 53 Cm (GN 1/1 Kapasiteli)
- * 35-40 Kg/m³ Çevre Dostu HCFC İçermeyen Poliüretan İzolasyon
- * Dijital Kumanda Paneli
- * Elektrik Rezistanslı Otomatik Defrost
- * Özel Su Buharlaştırma Sistemi
- * Yüksekliği Ayarlanabilir Paslanmaz Ayaklar
- * Özel, Kapı Menteşe Sistemi
- * Temizlenebilir ve Sökülebilir Manyetik Kapı Contası
- * Dış Ortam Sıcaklığı: + 43°C & % 65 Nem

Info

- * Inside Depth: 43 Cm / 53 Cm (GN 1/1 Capacity)
- * 35/40 Kg/m³ Ecology Friendly HCFC Free Polyurethane Isolation
- * Digital Control Panel
- * Electrical Resistor Automatic Defrost
- * Special Water Evaporation
- * Legs Adjustable For Height
- * Special Hinges and Door System
- * Removable and Easy Cleaning Magnetic Gaskets
- * Ambient Temperature: + 43°C % 65 Humidity

Kod Özellikleri / Available Codes

MR 450 € Raf ve Raf Kızağı Shelf and Shelf Holder	MR 450 € Mermer Üst Tabla Marble Work Top
DZ 0 € Düz Üst Tabla Straight Work Top	F 304 : -155 € 430 : -80 € Üst Tablasız Without Work Top
GR 811 € Granit Üst Tabla Granite Work Top	T 217 € Touch Dijital Touch Digital
PL 785 € Poliyeten Üst Tabla Polyethylene Work Top	W 90 € Tekerlekli Wheels
DKP 30 € Dijital Koruma Plastiği Digital Cover	60hz 56 € 220 V 60 Hz
WP 137 € Su Geçirmez Dijital Water Proof Digital	K 70 €/Unt Kilitli Kapı With Lock
BT 418 € Wi-Fi Dijital Wi-Fi Digital	

Paslanmaz Özelligi Stainless Steel Type	İzolasyon Kalınlığı Insulation Thickness	Raf Adedi Shelf Unit	Soğutma Gazı Cooling Gas	Voltaj Voltage	Enerji Sınıfı Energy Rating	Fiyat Price
304	60 mm	2	R290	220 V / 50 Hz	A	2.956 €
304	60 mm	2	R290	220 V / 50 Hz	A	3.030 €
304	60 mm	2	R290	220 V / 50 Hz	C	3.399 €
304	60 mm	2	R290	220 V / 50 Hz	C	3.487 €
430	60 mm	2	R290	220 V / 50 Hz	A	2.606 €
430	60 mm	2	R290	220 V / 50 Hz	A	2.676 €
430	60 mm	2	R290	220 V / 50 Hz	C	2.958 €
430	60 mm	2	R290	220 V / 50 Hz	C	3.029 €
304	60 mm	2	R290	220 V / 50 Hz	B	3.399 €
304	60 mm	2	R290	220 V / 50 Hz	B	3.473 €
430	60 mm	2	R290	220 V / 50 Hz	B	3.029 €
430	60 mm	2	R290	220 V / 50 Hz	B	3.099 €

Model Models	İç Sıcaklık Temperature	Brüt Hacim Gross volume	Ölçüler Dimensions	Paket Ölçüsü Packing Dim.	Ağırlık Weight	
	°C	Lt.	Cm.	Cm.	Kg.	
	GRN-CSN2-M	-2/+8	250	130x60x85	140x70x105	140
	GRN-CGN2-M	-2/+8	281	130x70x85	140x80x105	150
	GRN-CSL2-M	-10/-22	250	130x60x85	140x70x105	150
	GRN-CGL2-M	-10/-22	281	130x70x85	140x80x105	160
	GRN-BSN2-M	-2/+8	250	130x60x85	140x70x105	140
	GRN-BGN2-M	-2/+8	281	130x70x85	140x80x105	150
	GRN-BSL2-M	-10/-22	250	130x60x85	140x70x105	150
	GRN-BGL2-M	-10/-22	281	130x70x85	140x80x105	160
	GRN-CSN2-M-G	-2/+8	250	130x60x85	140x70x105	143
	GRN-CGN2-M-G	-2/+8	281	130x70x85	140x80x105	153
	GRN-BSN2-M-G	-2/+8	250	130x60x85	140x70x105	143
	GRN-BGN2-M-G	-2/+8	281	130x70x85	140x80x105	153

Yatay Buzdolapları - Mono Blok

Counter Type Refrigerators - Mono Block

Option : 189 €

115 V / 60 Hz

Monoblok Soğutma Sistemi
Monoblock Cooling Group

10 Min.
MONOBLOCK REPLACEMENT

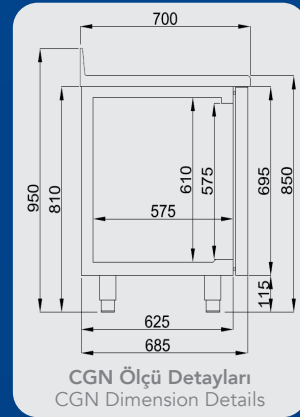

Özel Kendinden Kapanan Çekmece
Special Self Closing Drawer

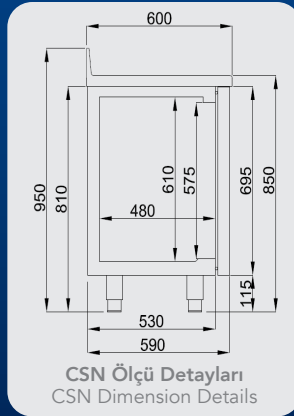

ENERGY EFFICIENT

FRENOX GRN-CGN3-M

A

364 kWh/annum

306 L - L 5 40°C-40%

Elektrik Testi
EN ISO 22041:2019
Standartlarında yapılmıştır.

Electricity Consumption
Test is Hold Under EN ISO
22041:2019 Standard.



GRN-CGN3-M-A

Bu seride üst tabla yuvarlatılmıştır.
This series have curved work top

Standart Sırt Yüksekliği 10 cm'dir.
Standart Splash Back Height is 10 cm.



Energy Efficiency Line Series

Çekmece Seçenekleri / Drawer Options

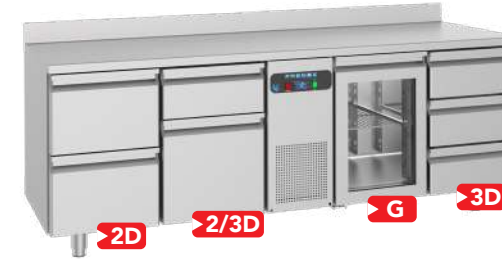

- 3D** 1/3 Çekmece - 1/3 Drawers 678 €
- 2D** 1/2 Çekmece - 1/2 Drawers 534 €
- G** Cam Kapı - Glass Door 234 €
- 2/3D** 2/3 Çekmece - 2/3 Drawers 588 €

Cam Kapı Sadece Pozitif Kapılar İçindir
Glass Door Option is Only Available for Positive Doors

Bilgi

- * İç Derinlik : 43 Cm / 53 Cm (GN 1/1 Kapasiteli)
- * 35-40 Kg/m³ Çevre Dostu HCFC İçermeyen Poliüretan İzolasyon
- * Dijital Kumanda Paneli
- * Elektrik Rezistanslı Otomatik Defrost
- * Özel Su Buharlaştırma Sistemi
- * Yüksekliği Ayarlanabilir Paslanmaz Ayaklar
- * Özel, Kapı Menteşe Sistemi
- * Temizlenebilir ve Sökülebilir Manyetik Kapı Contası
- * Dış Ortam Sıcaklığı: + 43°C & % 65 Nem

Info

- * Inside Depth: 43 Cm / 53 Cm (GN 1/1 Capacity)
- * 35-40 Kg/m³ Ecology Friendly HCFC Free Polyurethane Isolation
- * Digital Control Panel
- * Electrical Resistor Automatic Defrost
- * Special Water Evaporation
- * Legs Adjustable For Height
- * Special Hinges and Door System
- * Removable and Easy Cleaning Magnetic Gaskets
- * Ambient Temperature: + 43°C % 65 Humidity

Kod Özellikleri / Available Codes

Raf ve Raf Kızağı Shelf and Shelf Holder 49 €

MR 481 €

Mermer Üst Tabla Marble Work Top

DZ 0 €

Düz Üst Tabla Straight Work Top

F 304 : -174€
430 : -88 €

Üst Tablasız Without Work Top

GR 960 €

Granit Üst Tabla Granite Work Top

T 217 €

Touch Dijital Touch Digital

PL 932 €

Poliyeten Üst Tabla Polyethylene Work Top

W 90 €

Tekerlekli Wheels

DKP 30 €

Dijital Koruma Plastiği Digital Cover

60hz 56 €

220 V
60 Hz

WP 137 €

Su Geçirmez Dijital Water Proof Digital

K 70 €/Unt

Kilitli Kapı With Lock

BT 418 €

Wi-Fi Dijital Wi-Fi Digital

Model Models	İç Sıcaklık Temperature °C	Brüt Hacim Gross volume Lt.	Ölçüler Dimensions Cm.	Paket Ölçüsü Packing Dim. Cm.	Ağırlık Weight Kg.
	GRN-CSN3-M	-2/+8	178,5x60x85	188x70x105	150
	GRN-CGN3-M	-2/+8	178,5x70x85	188x80x105	160
	GRN-CSL3-M	-10/-22	178,5x60x85	188x70x105	160
	GRN-CGL3-M	-10/-22	178,5x70x85	188x80x105	170
	GRN-BSN3-M	-2/+8	178,5x60x85	188x70x105	150
	GRN-BGN3-M	-2/+8	178,5x70x85	188x80x105	160
	GRN-BSL3-M	-10/-22	178,5x60x85	188x70x105	160
	GRN-BGL3-M	-10/-22	178,5x70x85	188x80x105	170
	GRN-CSN3-M-G	-2/+8	178,5x60x85	188x70x105	155
	GRN-CGN3-M-G	-2/+8	178,5x70x85	188x80x105	165
	GRN-BSN3-M-G	-2/+8	178,5x60x85	188x70x105	155
	GRN-BGN3-M-G	-2/+8	178,5x70x85	188x80x105	165

Paslanmaz Özellikli Stainless Steel Type	İzolasyon Kalınlığı Insulation Thickness	Raf Adedi Shelf Unit	Soğutma Gazı Cooling Gas	Voltaj Voltage	Enerji Sınıfı Energy Rating	Fiyat Price €
304	60 mm	3	R290	220 V / 50 Hz	A	3.473 €
304	60 mm	3	R290	220 V / 50 Hz	A	3.547 €
304	60 mm	3	R290	220 V / 50 Hz	C	4.064 €
304	60 mm	3	R290	220 V / 50 Hz	C	4.138 €
430	60 mm	3	R290	220 V / 50 Hz	A	2.888 €
430	60 mm	3	R290	220 V / 50 Hz	A	2.958 €
430	60 mm	3	R290	220 V / 50 Hz	C	3.380 €
430	60 mm	3	R290	220 V / 50 Hz	C	3.451 €
304	60 mm	3	R290	220 V / 50 Hz	B	4.196 €
304	60 mm	3	R290	220 V / 50 Hz	B	4.269 €
430	60 mm	3	R290	220 V / 50 Hz	B	3.590 €
430	60 mm	3	R290	220 V / 50 Hz	B	3.660 €

Yatay Buzdolapları - Mono Blok

Counter Type Refrigerators - Mono Block



Option : 189 €

115 V / 60 Hz

R290



Özel Kendinden Kapanan Çekmece
Special Self Closing Drawer

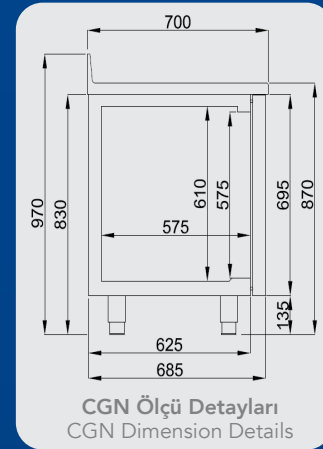

CGN Ölçü Detayları
CGN Dimension Details

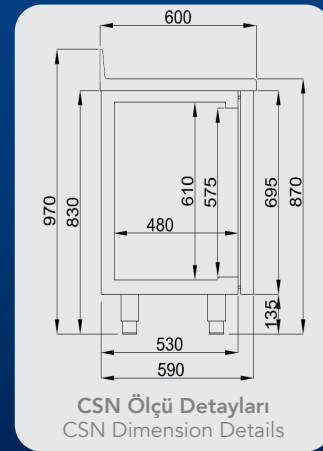

CSN Ölçü Detayları
CSN Dimension Details

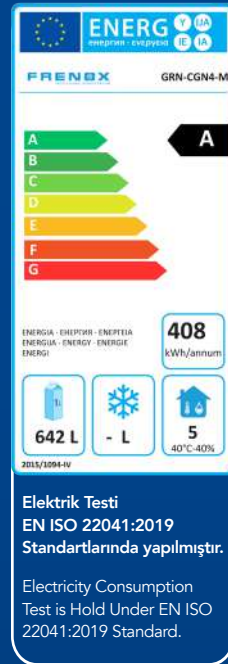

Elektrik Testi
EN ISO 22041:2019
Standartlarında yapılmıştır.

Electricity Consumption
Test is Hold Under EN ISO
22041:2019 Standard.



GRN-CGN4-M-A

Bu seride üst tabla yuvarlatılmıştır.
This series have curved work top

Standart Sırt Yüksekliği 10 cm'dir.
Standart Splash Back Height is 10 cm.



Energy Efficiency Line Series

Çekmece Seçenekleri / Drawer Options



3D 1/3 Çekmece - 1/3 Drawers 678 €

2D 1/2 Çekmece - 1/2 Drawers 534 €

G Cam Kapı - Glass Door 234 €

2/3D 2/3 Çekmece - 2/3 Drawers 588 €

Cam Kapı Sadece Pozitif Kapılar İçindir
Glass Door Option is Only Available for Positive Doors

Bilgi

- * İç Derinlik : 43 Cm / 53 Cm (GN 1/1 Kapasiteli)
- * 35-40 Kg/m³ Çevre Dostu HCFC İçermeyen Poliüretan İzolasyon
- * Dijital Kumanda Paneli
- * Elektrik Rezistanslı Otomatik Defrost
- * Özel Su Buharlaştırma Sistemi
- * Yüksekliği Ayarlanabilir Paslanmaz Ayaklar
- * Özel, Kapı Menteşe Sistemi
- * Temizlenebilir ve Sökülebilir Manyetik Kapı Contası
- * Dış Ortam Sıcaklığı: + 43°C & % 65 Nem

Info

- * Inside Depth: 43 Cm / 53 Cm (GN 1/1 Capacity)
- * 35-40 Kg/m³ Ecology Friendly HCFC Free Polyurethane Isolation
- * Digital Control Panel
- * Electrical Resistor Automatic Defrost
- * Special Water Evaporation
- * Legs Adjustable For Height
- * Special Hinges and Door System
- * Removable and Easy Cleaning Magnetic Gaskets
- * Ambient Temperature: + 43°C % 65 Humidity

Paslanmaz Özelligi Stainless Steel Type	İzolasyon Kalınlığı Insulation Thickness	Raf Adedi Shelf Unit	Soğutma Gazı Cooling Gas	Voltaj Voltage	Enerji Sınıfı Energy Rating	Fiyat Price
304	60 mm	4	R290	220 V / 50 Hz	A	3.842 €
304	60 mm	4	R290	220 V / 50 Hz	A	3.917 €
304	60 mm	4	R290	220 V / 50 Hz	C	5.691 €
304	60 mm	4	R290	220 V / 50 Hz	C	5.770 €
430	60 mm	4	R290	220 V / 50 Hz	A	3.380 €
430	60 mm	4	R290	220 V / 50 Hz	A	3.451 €
430	60 mm	4	R290	220 V / 50 Hz	C	4.832 €
430	60 mm	4	R290	220 V / 50 Hz	C	4.952 €
304	60 mm	4	R290	220 V / 50 Hz	B	4.806 €
304	60 mm	4	R290	220 V / 50 Hz	B	4.881 €
430	60 mm	4	R290	220 V / 50 Hz	B	4.317 €
430	60 mm	4	R290	220 V / 50 Hz	B	4.388 €

Model Models	İç Sıcaklık Temperature	Brüt Hacim Gross volume	Ölçüler Dimensions	Paket Ölçüsü Packing Dim.	Ağırlık Weight	
	°C	Lt.	Cm.	Cm.	Kg.	
	GRN-CSN4-M	-2/+8	550	227x60x85	237x70x100	170
	GRN-CGN4-M	-2/+8	632	227x70x85	237x80x100	180
	GRN-CSL4-M	-10/-22	550	227x60x85	237x70x100	180
	GRN-CGL4-M	-10/-22	632	227x70x85	237x80x100	190
	GRN-BSN4-M	-2/+8	550	227x60x85	237x70x100	170
	GRN-BGN4-M	-2/+8	632	227x70x85	237x80x100	180
	GRN-BSL4-M	-10/-22	550	227x60x85	237x70x100	180
	GRN-BGL4-M	-10/-22	632	227x70x85	237x80x100	198
	GRN-CSN4-M-G	-2/+8	550	227x60x85	237x70x100	178
GRN-CGN4-M-G	-2/+8	632	227x70x85	237x80x100	188	
GRN-BSN4-M-G	-2/+8	550	227x60x85	237x70x100	178	
GRN-BGN4-M-G	-2/+8	632	227x70x85	237x80x100	188	

Kod Özellikleri / Available Codes

Raf ve Raf Kızağı Shelf and Shelf Holder	49 €	MR	628 €
Mermer Üst Tabla Marble Work Top			
DZ	0 €	F	304 : -194 € 430 : -94 €
Düz Üst Tabla Straight Work Top			
Üst Tablasız Without Work Top			
GR	1249 €	T	217 €
Granit Üst Tabla Granite Work Top			
Touch Dijital Touch Digital			
PL	1197 €	W	90 €
Poliütilen Üst Tabla Polyethylene Work Top			
Tekerlekli Wheels			
DKP	30 €	60hz	56 €
Dijital Koruma Plastiği Digital Cover			220 V 60 hz
WP	137 €	K	70 €/Unt
Su Geçirmez Dijital Water Proof Digital			
Kilitli Kapı With Lock			
BT	418 €		
Wi-Fi Dijital Wi-Fi Digital			

126-127 **Kahve Otomatı için Süt Saklama Buzdolabı**
Milk Storage Refrigerator for Coffee Machines



Modüler Bar Sistemleri
Modular Bar Systems

128-129

130-131

Modüler Bar Sistemleri
Modular Bar Systems



Bira Soğutucu Buzdolabı - Tek Evyeli
Keg Refrigerator - One Sink

132-133
136-137

134-135
138-139

Bira Soğutucu Buzdolabı - Çift Evyeli
Keg Refrigerator - Double Sink



Bira Fıçı Soğutucu
Beer Keg Cooler

140-141

142-143

Fıçı Soğutucu
Keg Cooler



Yatay Buzdolapları
Counter Type Refrigerators

144-145

146-147

Şişe Soğutucu
Bottle Coolers



Şişe Soğutucu 1 Kapılı
Bottle Coolers 1 Door

148-149

150-151

Şişe Soğutucu 1 Kapılı
Bottle Coolers 1 Door



Bar Buzdolapları / PVC Kaplı Gövde
Bar Refrigerators / PVC Coated Body

152-153

154-155

Bar Buzdolapları/Paslanmaz Gövde
Bar Refrigerators/Stainless Steel Body



Bar Buzdolapları/Paslanmaz Gövde
Bar Refrigerators/Stainless Steel Body

156-157

158-159

Bar Buzdolapları - Bardak Soğutucu
Bar Refrigerators - Glass Frosters



Tezgahaltı Slim Buzdolapları
Slim Refrigerators

160-161

162-163

Kokteyl Tezgahı
Cocktail Refrigerator



Yatay Panel Buzdolabı - (Vakum Çekmece / Kapı İle)
Counter Panel Refrigerator - (With Vacuum Drawer / Door)

164-165
168-169

166-167
170-171

Yatay Panel Nötr Dolap
Counter Panel Neutral Cabinet



Özel Meşrubat Dolabı / PVC Kaplı Gövde
Special Beverage Refrigerator / PVC Coated Body

172-173

Kahve Otomatı için Süt Saklama Buzdolabı

Milk Storage Refrigerator for Coffee Machines



FRENOX
PROFESSIONAL REFRIGERATION

Bar Line Series

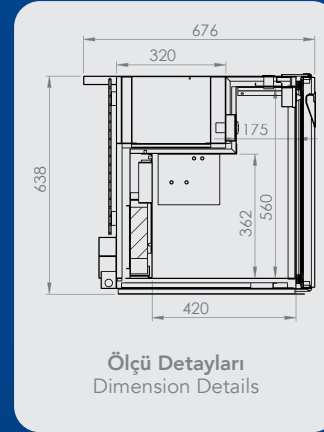

**Ankastre
Buzdolabı
Built-In
Refrigerator**

SHY70



SHY70



SHY70

Bilgi

- * 35-40 Kg/m³ Çevre Dostu HCFC İçermeyen Poliüretan İzolasyon
- * Fanlı Soğutma
- * Dijital Termometre & Termostat
- * Özel, Kapı Menteşe Sistemi
- * Temizlenebilir ve Sökülebilir Manyetik Kapı Contası
- * Plastik Kaplı Çelik Raf
- * Dış Ortam Sıcaklığı: + 43°C
- * Kolay Temizlenebilir Tel Kondenser

Info

- * 35-40 Kg/m³ Ecology Friendly HCFC Free Polyurethane Isolation
- * Fan Cooling
- * Digital Thermometer & Thermostat
- * Special Door and Hinge Systems
- * Removable and Easy Cleaning Magnetic Gaskets
- * Plastic Coated Steel Shelf
- * Ambient Temperature: + 43°C
- * Easy Cleaning Condenser

Model Models	İç Sıcaklık Temperature °C	Brüt Hacim Gross volume Lt.	Ölçüler Dimensions Cm.	Paket Ölçüsü Packing Dim. Cm.	Ağırlık Weight Kg.
 SHY70	-2/+8	110	53x68x62	60x70x70	68

Paslanmaz Özelliği Stainless Steel Type	İzolasyon Kalınlığı Insulation Thickness	Raf Adedi Shelf Unit	Soğutma Gazı Cooling Gas	Voltaj Voltage	Fiyat Price €
430	50 mm	-	R600A	220 V / 50 Hz	1.711 €

Modüler Bar Sistemleri

Modular Bar Systems

Kolay Montaj
Easy Assembly



Soketli Güç Kablosu
Special Power

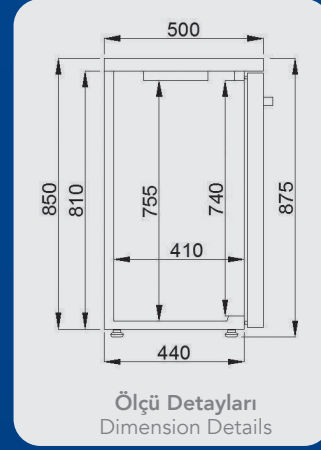

Option : 189 €

115 V / 60 Hz



FRENOX
PROFESSIONAL REFRIGERATION

Bar Line Series

Çekmece Seçenekleri / Drawer Options

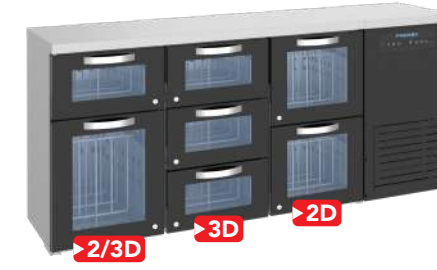

3D 1/3 Çekmece - 1/3 Drawers 968 €
2D 1/2 Çekmece - 1/2 Drawers 686 €
2/3D 2/3 Çekmece - 2/3 Drawers 898 €

Bilgi

- * 35-40 kg/m³ Çevre Dostu HCFC İçermeyen Poliüretan İzolasyon
- * Touch Kontrol Paneli
- * Modüler, Kolay Montaj Gövde
- * Her Kapı ve Çekmecede Led Aydınlatma
- * Paslanmaz Üst Tabla
- * Mono-blok Sökülebilir Soğutma Grubu
- * Temizlenebilir ve Sökülebilir Kir Tutmayan Conta
- * CFC Free Soğutma Gazı : R134 / R404 A
- * Dış Ortam : +32 C° %65 Bağıl Nem

Info

- * 35-40 kg/m³ Ecology Friendly HCFC Free Polyurethane Insulation
- * Touch Control Panel
- * Modular, Easy Assembly System
- * Special Led Lighting on Each Door and Drawer
- * Stainless Steel Work Top
- * Mono-block Removable Cooling Group
- * Removable & Easy Cleaning Magnetic Gasket
- * Cooling Gas CFC Free R134 / R404 A
- * Ambient Temperature +32 °C %65 Humidity

Kod Özellikleri
Available Codes

Raf ve Raf Kızağı
Shelf and Shelf Holder 49 €
MR 1 Door 339 €
2 Door 476 €
3 Door 610 €
Mermer Üst Tabla
Marble Work Top

GR 1 Door 543 €
2 Door 678 €
3 Door 895 €
Granit Üst Tabla
Granite Work Top
F 1 Door 82 €
2 Door 113 €
3 Door 144 €
Üst Tablasız
Without Work Top

PL 1 Door 498 €
2 Door 543 €
3 Door 678 €
Polietilen Üst Tabla
Polyethylene Work Top
BT 418 €
Wi-Fi Dijital
Wi-Fi Digital

Şişe Ayırıcı
Bottle Separator 32 €
CO 144 €
Renk Değiştiren LED
Colour Changable LED

60_{hz} 56 €
220 V
60 hz

Model Models	İç Sıcaklık Temperature °C	Şişe Kapasitesi Bottle Capacity Lt.	Ölçüler Dimensions Cm.	Paket Ölçüsü Packing Dim. Cm.	Ağırlık Weight Kg.	Paslanmaz Özelliği Stainless Steel Type
MB-100-T MB-100-T-R MB-100-T-L	0/+8	-	46x50x87,5	56x60x100	75	430
MB-150-L MB-150-R	0/+8	30/50	46x50x87,5	56x60x100	55	430
MB-250-L MB-250-R	0/+8	50/90	92x50x87,5	102x60x100	90	430
MB-350-L MB-350-R	0/+8	90/120	138x50x87,5	148x60x100	125	430

İzolasyon Kalınlığı Insulation Thickness	Raf Adedi Shelf Unit	Soğutma Gazı Cooling Gas	Voltaj Voltage	Fiyat Price €
40 mm	-	R134A	220 V / 50 Hz	2.410 €
30 mm	2	-	220 V / 50 Hz	1.508 €
30 mm	4	-	220 V / 50 Hz	1.730 €
30 mm	6	-	220 V / 50 Hz	2.384 €

Model Models	Fiyat Price
MB-100-T-R290 MB-100-T-R-R290 MB-100-T-L-R290	2.388 €

Modüler Bar Sistemleri

Modular Bar Systems

Kolay Montaj
Easy Assembly

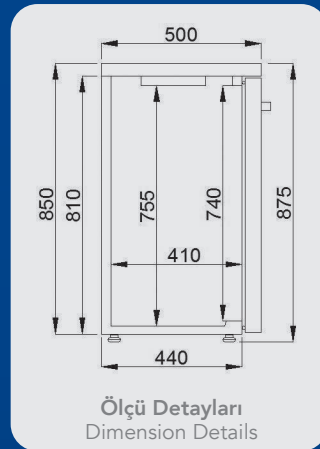
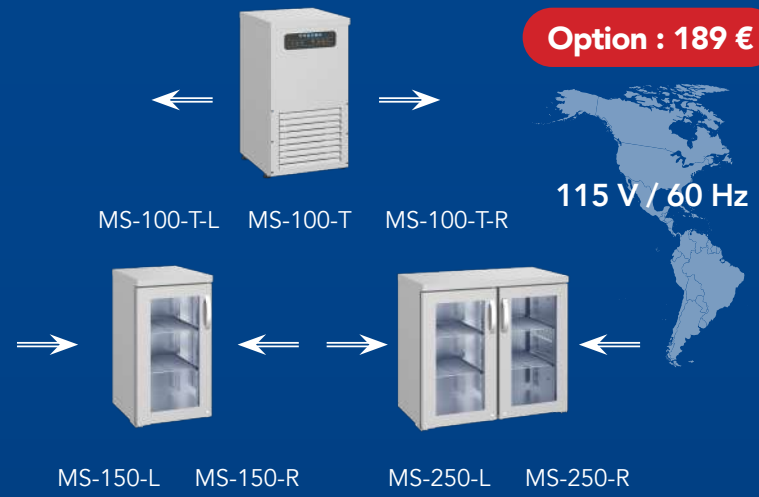

Soketli Güç Kablosu
Special Power



Farklı Kaplama
Seçenekleri
Different Cover
Options



Bar Line Series

Çekmece Seçenekleri / Drawer Options

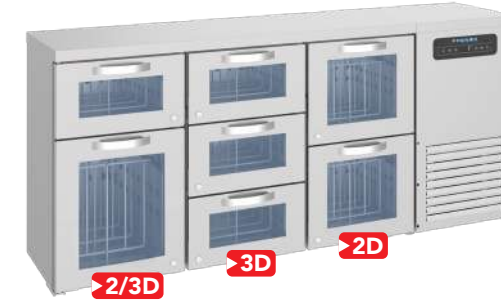

3D 1/3 Çekmece - 1/3 Drawers 592 €
2D 1/2 Çekmece - 1/2 Drawers 466 €
2/3D 2/3 Çekmece - 2/3 Drawers 514 €

Bilgi

- * 35-40 kg/m³ Çevre Dostu HCFC İçermeyen Poliüretan İzolasyon
- * Dokunmatik Kontrol Paneli
- * Modüler, Kolay Montaj Gövde
- * Her Kapı ve Çekmece Led Aydınlatma
- * Paslanmaz Üst Tabla
- * Monoblok Sökülebilir Soğutma Grubu
- * Temizlenebilir ve Sökülebilir Kir Tutmayan Conta
- * CFC Free Soğutma Gazı : R134 / R404 A
- * Dış Ortam : +32 C° %65 Bağıl Nem

Info

- * 35-40 kg/m³ Ecology Friendly HCFC Free Polyurethane Insulation
- * Touch Control Panel
- * Modular, Easy Assembly System
- * Special Led Lighting on Each Door and Drawer
- * Stainless Steel Work Top
- * Mono-block Removable Cooling Group
- * Removable & Easy Cleaning Magnetic Gasket
- * Cooling Gas CFC Free R134 / R404 A
- * Ambient Temperature +32 °C %65 Humidity

Kod Özellikleri Available Codes

Raf ve Raf Kızağı Shelf and Shelf Holder 49 €
MR 1 Door 339 €
2 Door 476 €
3 Door 610 €
Mermer Üst Tabla Marble Work Top

GR 1 Door 543 €
2 Door 678 €
3 Door 895 €
Granit Üst Tabla Granite Work Top
F 1 Door 82 €
2 Door 113 €
3 Door 144 €
Üst Tablasız Without Work Top

PL 1 Door 498 €
2 Door 543 €
3 Door 678 €
Poliyeten Üst Tabla Polyethylene Work Top
BT 418 €
Wi-Fi Dijital Wi-Fi Digital

Şişe Ayırıcı Bottle Separator 32 €
60^{hz} 56 €
220 V
60 hz

Model Models	İç Sıcaklık Temperature °C	Şişe Kapasitesi Bottle Capacity Lt.	Ölçüler Dimensions Cm.	Paket Ölçüsü Packing Dim. Cm.	Ağırlık Weight Kg.	Paslanmaz Özelliği Stainless Steel Type
MS-100-T MS-100-T-R MS-100-T-L	0/+8	-	46x50x87,5	56x60x100	75	430
MS-150	0/+8	30/50	46x50x87,5	56x60x100	55	430
MS-250	0/+8	50/90	92x50x87,5	102x60x100	90	430
MS-350	0/+8	50/120	138x50x87,5	148x60x100	125	430

İzolasyon Kalınlığı Insulation Thickness	Raf Adedi Shelf Unit	Soğutma Gazı Cooling Gas	Voltaj Voltage	Fiyat Price €	Model Models	Fiyat Price
40 mm	-	R134A	220 V / 50 Hz	2.288 €	MS-100-T-R290 MS-100-T-R-R290 MS-100-T-L-R290	2.264 €
30 mm	2	-	220 V / 50 Hz	1.255 €		
30 mm	4	-	220 V / 50 Hz	1.384 €		
30 mm	6	-	220 V / 50 Hz	1.759 €		

Bira Soğutucu Buzdolabı - Tek Evyeli

Keg Refrigerator - One Sink



Bar Line Series

Çekmece Seçenekleri / Drawer Options



- 3D** 1/3 Çekmece - 1/3 Drawers 637 €
- 2D** 1/2 Çekmece - 1/2 Drawers 504 €
- G** Cam Kapı - Glass Door 371 €
- 2/3D** 2/3 Çekmece - 2/3 Drawers 530 €

Çekmeceler Sadece Üretim Aşamasında Takılabilir
Drawer Option is Only Possible During Production

Bilgi

- * 35-40 Kg/m³ Çevre Dostu HCFC İçermeyen Poliüretan İzolasyon
- * Dijital Kumanda Paneli
- * Bara Uygun Kilit Sistemi
- * Özel Bira Damlalığı
- * Bira Kulesi Ekleme Opsiyonu
- * 30x50 Evyeye
- * Musluk Ekleme Seçeneği
- * Elektrik Rezistanslı Otomatik Defrost
- * Özel Su Buharlaştırma Sistemi
- * Temizlenebilir ve Sökülebilir Manyetik Kapı Contası
- * Dış Ortam Sıcaklığı: + 43°C & % 65 Nem

Info

- * 35-40 Kg/m³ Ecology Friendly HCFC Free Polyurethane Insulation
- * Digital Control Panel
- * Special Lock System Suitable For Bar Usage
- * Special Beer Dripper
- * Possibility to Add Beer Tower
- * 30x50 Sink
- * Possibility to Add Top
- * Electrical Resistor Automatic Defrost
- * Special Water Evaporation
- * Removable and Easy Cleaning Magnetic Gaskets
- * Ambient Temperature: + 43°C %65 Humidity



KGN3-E-R-TA-TO

Option : 189 €

115 V / 60 Hz

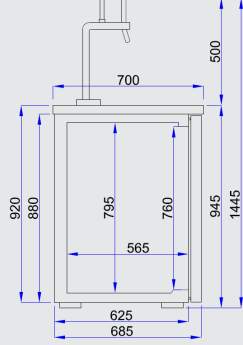

Ölçü Detayları
Dimension Details

Kod Özellikleri / Available Codes

Raf ve Raf Kızağı / Shelf and Shelf Holder 49 €

T 217 €

Touch Dijital / Touch Digital

F 2 Door - 424 €
3 Door - 463 €
4 Door - 502 €

Üst Tablasız / Without Work Top

BT 418 €

Wi-Fi Dijital / Wi-Fi Digital

WP 137 €

Su Geçirmez Dijital / Water Proof Digital

BW 339 €

Bardak Yıkama / Glass Washer

TA 339 €

Musluk / Tap

60hz 56 €

220 V / 60 hz

TO 1623 €/Unt

Kule / Tower

Model Models	İç Sıcaklık Temperature °C	Brüt Hacim Gross volume Lt.	Ölçüler Dimensions Cm.	Paket Ölçüsü Packing Dim. Cm.	Ağırlık Weight Kg.	Paslanmaz Özelliği Stainless Steel Type
	KGN2-E-R	-2/+8	2 Fiçi / Keg	155x70x94,5	165x80x110	200 / 430
	KGN2-E-L	-2/+8	2 Fiçi / Keg	155x70x94,5	165x80x110	200 / 430
	KGN3-E-R	-2/+8	3 Fiçi / Keg	210x70x94,5	220x80x110	251 / 430
	KGN3-E-L	-2/+8	3 Fiçi / Keg	210x70x94,5	220x80x110	251 / 430
	KGN4-E-R	-2/+8	4 Fiçi / Keg	265x70x94,5	275x80x110	300 / 430
	KGN4-E-L	-2/+8	4 Fiçi / Keg	265x70x94,5	275x80x110	300 / 430

İzolasyon Kalınlığı Insulation Thickness	Raf Adedi Shelf Unit	Soğutma Gazı Cooling Gas	Voltaj Voltage	Fiyat Price €	Model Models	Fiyat Price
60 mm	2	R134A	220 V / 50 Hz	2.784 €	KGN-E-R-R290	2.758 €
60 mm	2	R134A	220 V / 50 Hz	2.784 €	KGN-E-L-R290	2.758 €
60 mm	3	R134A	220 V / 50 Hz	3.199 €	KGN-E-R-R290	3.172 €
60 mm	3	R134A	220 V / 50 Hz	3.199 €	KGN-E-L-R290	3.172 €
60 mm	4	R134A	220 V / 50 Hz	3.411 €	KGN-E-R-R290	3.384 €
60 mm	4	R134A	220 V / 50 Hz	3.411 €	KGN-E-L-R290	3.384 €

Ürün düz tabla alındığı takdirde fiyattan %10 indirim yapılacaktır. / Musluk ve kule fiyata dahil değildir.

When ordered with straight work top, there will be %10 discount. / Tap and tower not included.

Bira Soğutucu Buzdolabı - Çift Evyeli

Keg Refrigerator - Double Sink



Sol eveye opsiyonu
Left sink option



Option : 189 €

115 V / 60 Hz

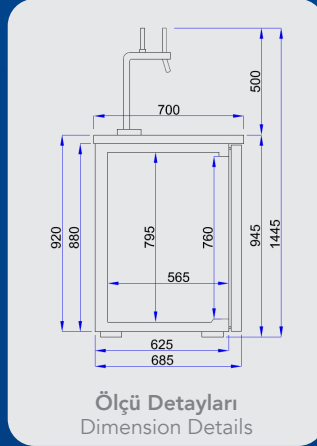

KGN3-2E-R-TA-TO



Bar Line Series

Çekmece Seçenekleri / Drawer Options



- 3D** 1/3 Çekmece - 1/3 Drawers 637 €
- 2D** 1/2 Çekmece - 1/2 Drawers 504 €
- G** Cam Kapı - Glass Door 371 €
- 2/3D** 2/3 Çekmece - 2/3 Drawers 530 €

Çekmeceler Sadece Üretim Aşamasında Takılabilir
Drawer Option is Only Possible During Production

Bilgi

- * 35-40 Kg/m³ Çevre Dostu HCFC İçermeyen Poliüretan İzolasyon
- * Dijital Kumanda Paneli
- * Özel Bira Damlalığı
- * Bira Kulesi Ekleme Opsiyonu
- * 30x50 Eveye
- * Musluk Ekleme Seçeneği
- * Elektrik Rezistanslı Otomatik Defrost
- * Özel Su Buharlaştırma Sistemi
- * Temizlenebilir ve Sökülebilir Manyetik Kapı Contası
- * Dış Ortam Sıcaklığı: + 43°C & % 65 Nem

Info

- * 35-40 Kg/m³ Ecology Friendly HCFC Free Polyurethane Insulation
- * Digital Control Panel
- * Special Beer Dripper
- * Possibility to Add Beer Tower
- * 30x50 Sink
- * Possibility to Add Top
- * Electrical Resistor Automatic Defrost
- * Special Water Evaporation
- * Removable and Easy Cleaning Magnetic Gaskets
- * Ambient Temperature: + 43°C %65 Humidity

Kod Özellikleri Available Codes

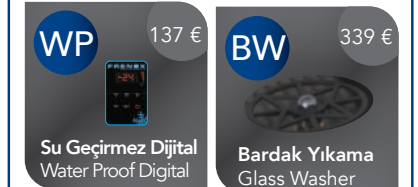

Model Models	İç Sıcaklık Temperature °C	Brüt Hacim Gross volume Lt.	Ölçüler Dimensions Cm.	Paket Ölçüsü Packing Dim. Cm.	Ağırlık Weight Kg.	Paslanmaz Özelliği Stainless Steel Type	
	KGN2-2E-R	-2/+8	2 Fiç/ Keg	195x70x94,5	205x80x110	225	430
	KGN2-2E-L	-2/+8	2 Fiç/ Keg	195x70x94,5	205x80x110	225	430
	KGN3-2E-R	-2/+8	3 Fiç/ Keg	250x70x94,5	260x80x110	287	430
	KGN3-2E-L	-2/+8	3 Fiç/ Keg	250x70x94,5	260x80x110	287	430

Musluk ve kule fiyata dahil değildir.

İzolasyon Kalınlığı Insulation Thickness	Raf Adedi Shelf Unit	Soğutma Gazı Cooling Gas	Voltaj Voltage	Fiyat Price €	Model Models	Fiyat Price
60 mm	2	R134A	220 V / 50 Hz	2.932 €	KGN2-2E-R-R290	2.907 €
60 mm	2	R134A	220 V / 50 Hz	2.932 €	KGN2-2E-L-R290	2.907 €
60 mm	3	R134A	220 V / 50 Hz	3.835 €	KGN3-2E-R-R290	3.809 €
60 mm	3	R134A	220 V / 50 Hz	3.835 €	KGN3-2E-L-R290	3.809 €

Tap and tower not included.

Bira Soğutucu Buzdolabı - Tek Evyeli

Keg Refrigerator - One Sink



BBN3-E-R-5D-T-TO-TA-BW

Touch Dijital standart üretiminde mevcut değildir. Fiyat için yan sayfaya bakınız.
Touch Digital is not available in standart production. Check the options for the price.

Option : 189 €

115 V / 60 Hz

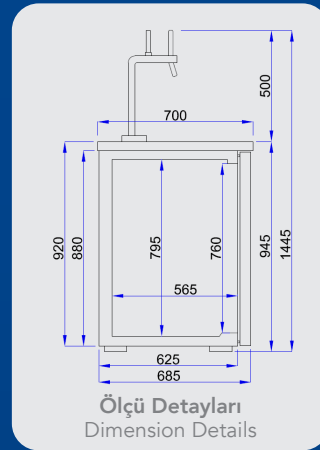

Ölçü Detayları
Dimension Details

Özel Kilit Sistemi
Special Lock System



Bar Line Series

Çekmece Seçenekleri / Drawer Options

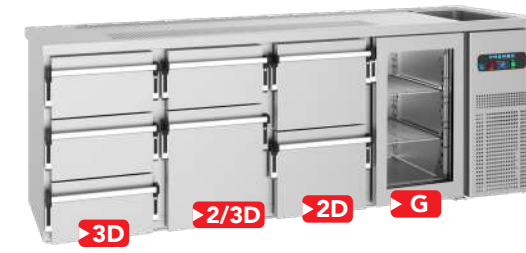

- 3D** 1/3 Çekmece - 1/3 Drawers 902 €
- 2D** 1/2 Çekmece - 1/2 Drawers 658 €
- G** Cam Kapı - Glass Door 345 €
- 2/3D** 2/3 Çekmece - 2/3 Drawers 759 €

Çekmeceler Sadece Üretim Aşamasında Takılabilir
Drawer Option is Only Possible During Production

Bilgi

- * 35-40 Kg/m³ Çevre Dostu HCFC İçermeyen Poliüretan İzolasyon
- * Dijital Kumanda Paneli
- * Bara Uygun Kilit Sistemi
- * Özel Bira Damlalığı
- * Bira Kulesi Ekleme Opsiyonu
- * 30x50 Evye
- * Musluk Ekleme Seçeneği
- * Elektrik Rezistanslı Otomatik Defrost
- * Özel Su Buharlaştırma Sistemi
- * Temizlenebilir ve Sökülebilir Manyetik Kapı Contası
- * Dış Ortam Sıcaklığı: + 43°C & % 65 Nem

Info

- * 35-40 Kg/m³ Ecology Friendly HCFC Free Polyurethane Insulation
- * Digital Control Panel
- * Special Lock System Suitable For Bar Usage
- * Special Beer Dripper
- * Possibility to Add Beer Tower
- * 30x50 Sink
- * Possibility to Add Top
- * Electrical Resistor Automatic Defrost
- * Special Water Evaporation
- * Removable and Easy Cleaning Magnetic Gaskets
- * Ambient Temperature: + 43°C %65 Humidity

Kod Özellikleri Available Codes

- Raf ve Raf Kızağı Shelf and Shelf Holder** 49 €
- T** 217 €
- Touch Dijital Touch Digital**

- F** 2 Door - 424 €
3 Door - 463 €
4 Door - 502 €
- BT** 418 €
- Üst Tablasız Without Work Top**
- Wi-Fi Dijital Wi-Fi Digital**

- WP** 137 €
- BW** 339 €
- Su Geçirmez Dijital Water Proof Digital**
- Bardak Yıkama Glass Washer**

- TA** 339 €
- 60hz** 56 €
- Musluk / Tap**
- 220 V 60 hz**

- TO** 1623 €/Unt
- Kule Tower**

Model Models	İç Sıcaklık Temperature °C	Brüt Hacim Gross volume Lt.	Ölçüler Dimensions Cm.	Paket Ölçüsü Packing Dim. Cm.	Ağırlık Weight Kg.	Paslanmaz Özelligi Stainless Steel Type
	BBN2-E-R	-2/+8	2 Fiçi / Keg	155x70x94,5	165x80x110	200 430
	BBN2-E-L	-2/+8	2 Fiçi / Keg	155x70x94,5	165x80x110	200 430
	BBN3-E-R	-2/+8	3 Fiçi / Keg	210x70x94,5	220x80x110	251 430
	BBN3-E-L	-2/+8	3 Fiçi / Keg	210x70x94,5	220x80x110	251 430
	BBN4-E-R	-2/+8	4 Fiçi / Keg	265x70x94,5	275x80x110	300 430
	BBN4-E-L	-2/+8	4 Fiçi / Keg	265x70x94,5	275x80x110	300 430

Ürün düz tabla alındığı takdirde fiyattan %10 indirim yapılacaktır. / Musluk ve kule fiyata dahil değildir.

İzolasyon Kalınlığı Insulation Thickness	Raf Adedi Shelf Unit	Soğutma Gazı Cooling Gas	Voltaj Voltage	Fiyat Price €	Model Models	Fiyat Price
60 mm	2	R134A	220 V / 50 Hz	3.171 €	BBN2-E-R-R290	3.240 €
60 mm	2	R134A	220 V / 50 Hz	3.171 €	BBN2-E-L-R290	3.240 €
60 mm	3	R134A	220 V / 50 Hz	3.774 €	BBN3-E-R-R290	3.862 €
60 mm	3	R134A	220 V / 50 Hz	3.774 €	BBN3-E-L-R290	3.862 €
60 mm	4	R134A	220 V / 50 Hz	4.394 €	BBN4-E-R-R290	4.500 €
60 mm	4	R134A	220 V / 50 Hz	4.394 €	BBN4-E-L-R290	4.500 €

When ordered with straight work top, there will be %10 discount. / Tap and tower not included.

Bira Soğutucu Buzdolabı - Çift Evyeli

Keg Refrigerator - Double Sink



Sol evye
opsiyonu
Left sink
option



Option : 189 €

115 V / 60 Hz

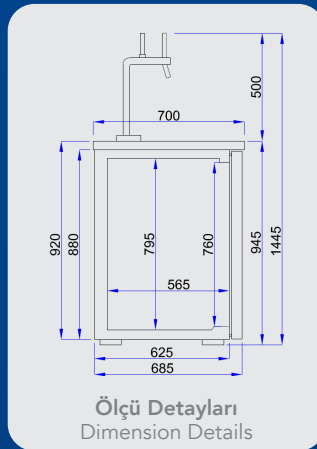

Ölçü Detayları
Dimension Details



BBN2-2E-5D-TO-TA

Özel Kilit Sistemi
Special Lock System



Bar Line Series

Çekmece Seçenekleri / Drawer Options

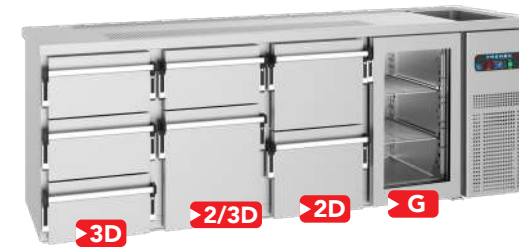

- 3D** 1/3 Çekmece - 1/3 Drawers 902 €
- 2D** 1/2 Çekmece - 1/2 Drawers 658 €
- G** Cam Kapı - Glass Door 345 €
- 2/3D** 2/3 Çekmece - 2/3 Drawers 759 €

Çekmeceler Sadece Üretim Aşamasında Takılabilir
Drawer Option is Only Possible During Production

Bilgi

- * 35-40 Kg/m³ Çevre Dostu HCFC İçermeyen Poliüretan İzolasyon
- * Dijital Kumanda Paneli
- * Bara Uygun Kilit Sistemi
- * Özel Bira Damlalığı
- * Bira Kulesi Ekleme Opsiyonu
- * 30x50 Evye
- * Musluk Ekleme Seçeneği
- * Elektrik Rezistanslı Otomatik Defrost
- * Özel Su Buharlaştırma Sistemi
- * Temizlenebilir ve Sökülebilir Manyetik Kapı Contası
- * Dış Ortam Sıcaklığı: + 43°C & % 65 Nem

Info

- * 35-40 Kg/m³ Ecology Friendly HCFC Free Polyurethane Insulation
- * Digital Control Panel
- * Special Lock System Suitable For Bar Usage
- * Special Beer Dripper
- * Possibility to Add Beer Tower
- * 30x50 Sink
- * Possibility to Add Top
- * Electrical Resistor Automatic Defrost
- * Special Water Evaporation
- * Removable and Easy Cleaning Magnetic Gaskets
- * Ambient Temperature: + 43°C %65 Humidity

Kod Özellikleri
Available Codes

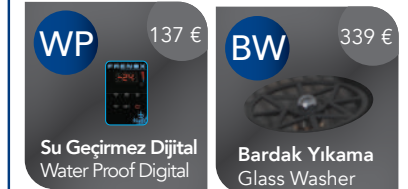

Model Models	İç Sıcaklık Temperature °C	Brüt Hacim Gross volume Lt.	Ölçüler Dimensions Cm.	Paket Ölçüsü Packing Dim. Cm.	Ağırlık Weight Kg.	Paslanmaz Özelliği Stainless Steel Type
 BBN2-2E-R	-2/+8	2 Fiç/ Keg	195x70x94,5	205x80x110	225	430
 BBN2-2E-L	-2/+8	2 Fiç/ Keg	195x70x94,5	205x80x110	225	430
 BBN3-2E-R	-2/+8	3 Fiç/ Keg	250x70x94,5	260x80x110	287	430
 BBN3-2E-L	-2/+8	3 Fiç/ Keg	250x70x94,5	260x80x110	287	430

Musluk ve kule fiyata dahil değildir.

İzolasyon Kalınlığı Insulation Thickness	Raf Adedi Shelf Unit	Soğutma Gazı Cooling Gas	Voltaj Voltage	Fiyat Price €	Model Models	Fiyat Price
60 mm	2	R134A	220 V / 50 Hz	4.032 €	BBN2-2E-R-R290	4.007 €
60 mm	2	R134A	220 V / 50 Hz	4.032 €	BBN2-2E-L-R290	4.007 €
60 mm	3	R134A	220 V / 50 Hz	4.465 €	BBN3-2E-R-R290	4.439 €
60 mm	3	R134A	220 V / 50 Hz	4.465 €	BBN3-2E-L-R290	4.439 €

Tap and tower not included.

Bira Fıçı Soğutucusu

Beer Keg Refrigerator



FRENOX
PROFESSIONAL REFRIGERATION

Bar Line Series

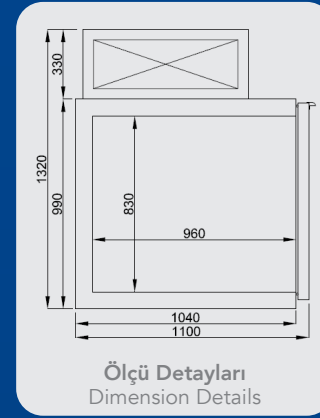

Option : 189 €

115 V / 60 Hz

Modüler
Panel
Buzdolabı
Modular
Panel



MB200 + KEG-6

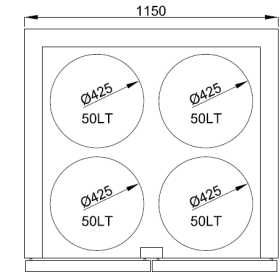

KEG4

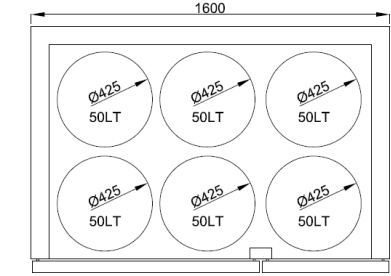

KEG6

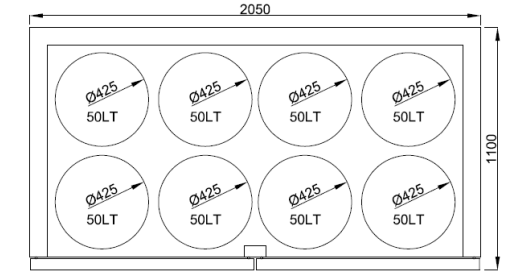

KEG8

Bilgi

- * 35-40 Kg/m³ Çevre Dostu HCFC İçermeyen Poliüretan İzolasyon
- * Dijital Kumanda Paneli
- * Elektrik Rezistanslı Otomatik Defrost
- * Özel Su Buharlaştırma Sistemi
- * Özel, Kapı Mentеше Sistemi
- * Temizlenebilir ve Sökülebilir Manyetik Kapı Contası
- * Dış Ortam Sıcaklığı: + 43°C & % 65 Nem

Info

- * 35-40 Kg/m³ Ecology Friendly HCFC Free Polyurethane İsolasyon
- * Digital Control Panel
- * Electrical Resistor Automatic Defrost
- * Special Water Evaporation
- * Special Hinges and Door System
- * Removable and Easy Cleaning Magnetic Gaskets
- * Ambient Temperature: + 43°C % 65 Humidity

Kod Özellikleri

Available Codes



Model Models	İç Sıcaklık Temperature °C	50 Lt. Keg Fıçı 50 Lt. Keg Beer	Ölçüler Dimensions Cm.	Paket Ölçüsü Packing Dim. Cm.	Ağırlık Weight Kg.	Paslanmaz Özelliği Stainless Steel Type
MB200	-2/+8	-	65X78X34	75X88X44	45	430
KEG-4	-	4 Ad.	115x110x99	125x120x117	120	430
KEG-6	-	6 Ad.	160x110x99	170x120x117	140	430
KEG-8	-	8 Ad.	205x110x99	215x120x117	160	430

İzolasyon Kalınlığı Insulation Thickness	Raf Adedi Shelf Unit	Soğutma Gazı Cooling Gas	Voltaj Voltage	Fiyat Price €
80 mm	-	R134A	220-230	1.293 €
80 mm	-	R134A	220-230	1.408 €
80 mm	-	R134A	220-230	1.902 €
80 mm	-	R134A	220-230	2.254 €

Model Models	Fiyat Price
MB200-R290	1.232 €

Fiçi Soğutucu Keg Cooler



Bar Line Series

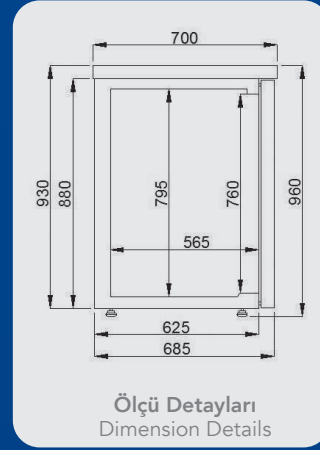

SGN4-TO

Option : 189 €

115 V / 60 Hz

Çekmece Seçenekleri / Drawer Options

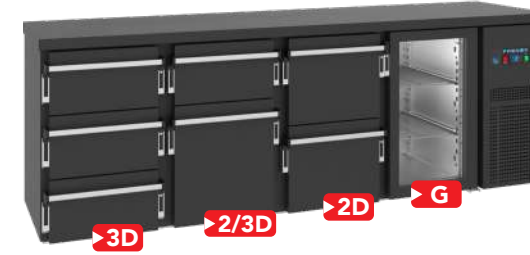

3D 1/3 Çekmece - 1/3 Drawers 791 €

2D 1/2 Çekmece - 1/2 Drawers 573 €

G Cam Kapı - Glass Door 302 €

2/3D 2/3 Çekmece - 2/3 Drawers 658 €

Çekmeceler Sadece Üretim Aşamasında Takılabilir
Drawer Option is Only Possible During Production

Bilgi

- * Dış Gövde Siyah PVC Kaplı Galvaniz Sac
- * 35-40 Kg/m³ Çevre Dostu HCFC İçermeyen Poliüretan İzolasyon
- * Fanlı Soğutma
- * Dijital Termometre & Termostat
- * Otomatik Defrost
- * Kapılarda Kilit
- * Yüksekliği Ayarlanabilir Ayaklar
- * Özel, Kapı Menteşe Sistemi
- * Temizlenebilir ve Sökülebilir Manyetik Kapı Contası
- * Plastik Kaplı Çelik Raf
- * Dış Ortam Sıcaklığı: + 32°C

Info

- * Outside Body Black PVC Coated Galvanized Sheet
- * 35-40 Kg/m³ Ecology Friendly HCFC Free Polyurethane Insulation
- * Fan Cooling
- * Digital Thermometer & Thermostat
- * Automatic Defrost
- * Locks on Each Door
- * Legs Adjustable For Height
- * Special Door and Hinge Systems
- * Removable and Easy Cleaning Magnetic Gaskets
- * Plastic Coated Steel Shelf
- * Ambient Temperature: + 32°C

Kod Özellikleri / Available Codes

Raf ve Raf Kızağı / Shelf and Shelf Holder 49 €	GR 2 Door 853 € 3 Door 1057 € 4 Door 1446 €
A 498 €	PL 2 Door 825 € 3 Door 1010 € 4 Door 1380 €
MR 2 Door 498 € 3 Door 531 € 4 Door 727 €	TO 1623 €/Unt
F 2 Door -139 € 3 Door -160 € 4 Door -182 €	T 217 €
BW 339 €	BT 418 €
WP 137 €	60hz 56 €
L 30 €	

Model Models	İç Sıcaklık Temperature °C	Brüt Hacim Gross volume Lt.	Ölçüler Dimensions Cm.	Paket Ölçüsü Packing Dim. Cm.	Ağırlık Weight Kg.	Paslanmaz Özelliği Stainless Steel Type
SGN1	-2/+8	1 Fiçi / Keg	111x70x96	121x80x110	145	Outside : Black Inside : 430
SGN2	-2/+8	2 Fiçi / Keg	155x70x96	165x80x110	160	Outside : Black Inside : 430
SGN3	-2/+8	3 Fiçi / Keg	208x70x96	218x80x110	185	Outside : Black Inside : 430
SGN4	-2/+8	4 Fiçi / Keg	265x70x96	275x80x110	220	Outside : Black Inside : 430

İzolasyon Kalınlığı Insulation Thickness	Raf Adedi Shelf Unit	Soğutma Gazı Cooling Gas	Voltaj Voltage	Fiyat Price €	Model Models	Fiyat Price
60 mm	2	R134A	220 V / 50 Hz	2.213 €	SGN1-R290	2.186 €
60 mm	4	R134A	220 V / 50 Hz	2.535 €	SGN2-R290	2.507 €
60 mm	6	R134A	220 V / 50 Hz	2.745 €	SGN3-R290	2.717 €
60 mm	8	R134A	220 V / 50 Hz	3.428 €	SGN4-R290	3.400 €

Yatay Buzdolapları

Counter Type Refrigerators

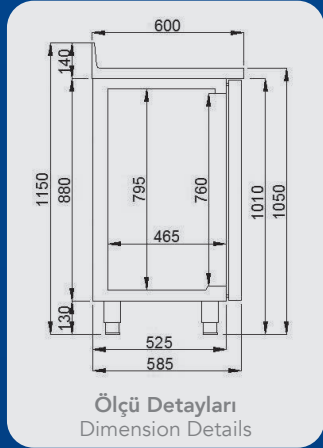

KGN3-K-G

Option : 189 €

115 V / 60 Hz



Bar Line Series

Çekmece Seçenekleri / Drawer Options



- 3D** 1/3 Çekmece - 1/3 Drawers 597 €
- 2D** 1/2 Çekmece - 1/2 Drawers 469 €
- G** Cam Kapı - Glass Door 228 €
- 2/3D** 2/3 Çekmece - 2/3 Drawers 564 €

Bilgi

- * 35-40 Kg/m³ Çevre Dostu HCFC İçermeyen Poliüretan İzolasyon
- * Dijital Kumanda Paneli
- * Elektrik Rezistanslı Otomatik Defrost
- * Özel Su Buharlaştırma Sistemi
- * Yüksekliği Ayarlanabilir Paslanmaz Ayaklar
- * Özel, Kapı Mentеше Sistemi
- * Temizlenebilir ve Sökülebilir Manyetik Kapı Contası
- * Dış Ortam Sıcaklığı: + 43°C & % 65 Nem

Info

- * 35-40 Kg/m³ Ecology Friendly HCFC Free Polyurethane Insulation
- * Digital Control Panel
- * Electrical Resistor Automatic Defrost
- * Special Water Evaporation
- * Stainless Steel Legs Adjustable For Height
- * Special Hinges and Door System
- * Removable and Easy Cleaning Magnetic Gaskets
- * Ambient Temperature: + 43°C %65 Humidity

Kod Özellikleri

Available Codes

Raf ve Raf Kızağı Shelf and Shelf Holder 49 €

GR 2 Door 858 €
3 Door 1057 €
4 Door 1374 €

Granit Üst Tabla Granite Work Top

DZ 0 €

Düz Üst Tabla Straight Work Top

PL 2 Door 780 €
3 Door 1014 €
4 Door 1316 €

Polietilen Üst Tabla Polyethylene Work Top

MR 2 Door 418 €
3 Door 502 €
4 Door 727 €

Mermer Üst Tabla Marble Work Top

DKP 30 €

Dijital Koruma Plastiği Digital Cover

F 2 Door -109 €
3 Door -182 €
4 Door -221 €

Üst Tablasız Without Work Top

WP 137 €

Su Geçirmez Dijital Water Proof Digital

T 217 €

Touch Dijital Touch Digital

BT 418 €

Wi-Fi Dijital Wi-Fi Digital

W 90 €



Tekerlekli Wheels

K 70 €/Unt

Kilitli Kapı With Lock

60_{hz} 56 €

220 V
60 hz

Model Models	İç Sıcaklık Temperature °C	Brüt Hacim Gross volume Lt.	Ölçüler Dimensions Cm.	Paket Ölçüsü Packing Dim. Cm.	Ağırlık Weight Kg.	Paslanmaz Özellikli Stainless Steel Type
 KSN2-K	-2/+8	550	158x60x105	168x70x115	170	430
 KSN3-K	-2/+8	632	213,5x60x105	223,5x70x115	200	430
 KSN4-K	-2/+8	710	269x60x105	279x70x115	244	430

İzolasyon Kalınlığı Insulation Thickness	Raf Adedi Shelf Unit	Soğutma Gazı Cooling Gas	Voltaj Voltage	Enerji Sınıfı Energy Rating	Fiyat Price €	Model Models	Fiyat Price
60 mm	4	R134A	220 V / 50 Hz	D	2.858 €	KSN2-K-R290	2.831 €
60 mm	6	R134A	220 V / 50 Hz	D	3.230 €	KSN3-K-R290	3.204 €
60 mm	8	R134A	220 V / 50 Hz	D	3.661 €	KSN4-K-R290	3.634 €

G : Cam Kapı / G : Glass Door

Şişe Soğutucu Bottle Coolers

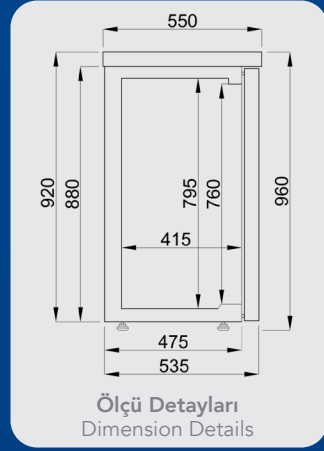

Option : 189 €

115 V / 60 Hz

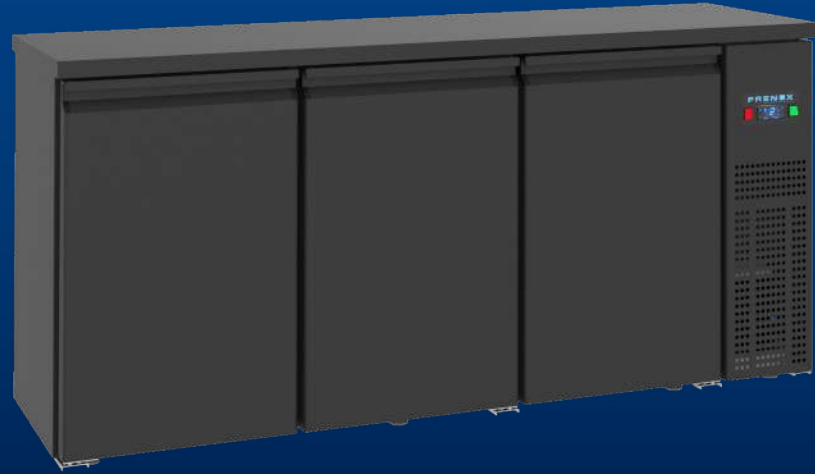

SSN3-55-SH



Bar Line Series

Çekmece Seçenekleri / Drawer Options

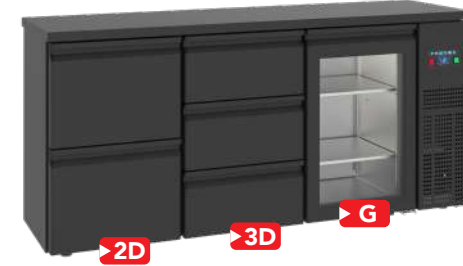

SSN3-55-SH-5D-G

- 3D** 1/3 Çekmece - 1/3 Drawers 576 €
- 2D** 1/2 Çekmece - 1/2 Drawers 461 €
- G** Cam Kapı - Glass Door 218 €

Çekmeceler Sadece Üretim Aşamasında Takılabilir
Drawer Option is Only Possible During Production

Bilgi





- * Dış Gövde Siyah PVC Kaplı Galvaniz Sac
- * 35-40 Kg/m³ Çevre Dostu HCFC İçermeyen Poliüretan İzolasyon
- * Fanlı Soğutma
- * Dijital Termometre & Termostat
- * Otomatik Defrost
- * Kapılarda Kilit
- * Yüksekliği Ayarlanabilir Ayaklar
- * Özel, Kapı Mentеше Sistemi
- * Temizlenebilir ve Sökülebilir Manyetik Kapı Contası
- * Plastik Kaplı Çelik Raf
- * Dış Ortam Sıcaklığı: + 32°C

Info

- * Outside Body Black PVC Coated Galvanized Sheet
- * 35-40 Kg/m³ Ecology Friendly HCFC Free Polyurethane Insulation
- * Fan Cooling
- * Digital Thermometer & Thermostat
- * Automatic Defrost
- * Locks on Each Door
- * Legs Adjustable For Height
- * Special Door and Hinge Systems
- * Removable and Easy Cleaning Magnetic Gaskets
- * Plastic Coated Steel Shelf
- * Ambient Temperature: + 32°C

Kod Özellikleri Available Codes



Model Models	İç Sıcaklık Temperature °C	Brüt Hacim Gross volume Lt.	Ölçüler Dimensions Cm.	Paket Ölçüsü Packing Dim. Cm.	Ağırlık Weight Kg.	Paslanmaz Özellikli Stainless Steel Type
 SSN1-55	-2/+8	140	113x55x95	123x65x110	140	Outside: Black Inside: 430
 SSN2-55-SH	-2/+8	320	138x55x95	148x65x110	150	Outside: Black Inside: 430
 SSN3-55-SH	-2/+8	500	194x55x95	204x65x110	160	Outside: Black Inside: 430
 SSN4-55-SH	-2/+8	680	249x55x95	259x65x110	180	Outside: Black Inside: 430

İzolasyon Kalınlığı Insulation Thickness	Raf Adedi Shelf Unit	Soğutma Gazı Cooling Gas	Voltaj Voltage	Enerji Sınıfı Energy Rating	Fiyat Price €	Model Models	Fiyat Price
60 mm	2	R290	220 V / 50 Hz	D	2.242 €	SSN1-55-R290	2.215 €
60 mm	4	R134A	220 V / 50 Hz	D	2.456 €	SSN2-55-SH-R290	2.429 €
60 mm	6	R134A	220 V / 50 Hz	D	2.916 €	SSN3-55-SH-R290	2.888 €
60 mm	8	R134A	220 V / 50 Hz	D	3.282 €	SSN4-55-SH-R290	3.254 €

Şişe Soğutucu - Arkası Kapılı

Bottle Coolers - With Back Door

Option : 189 €

115 V / 60 Hz

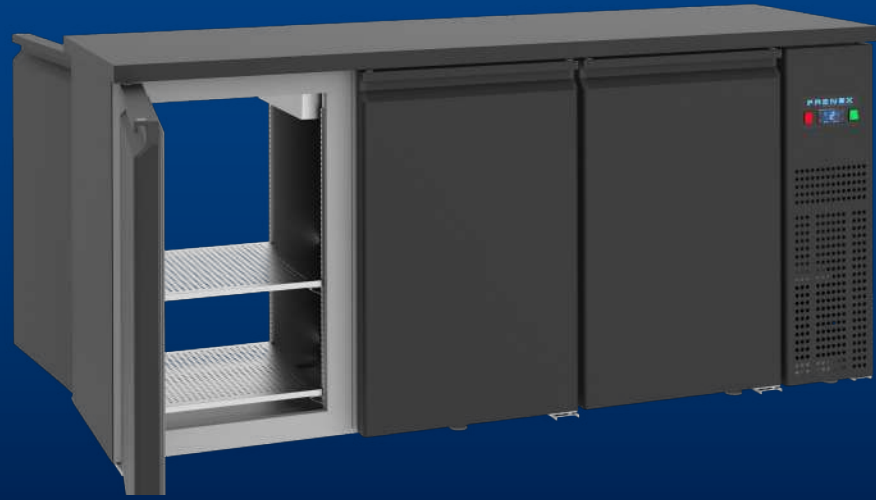
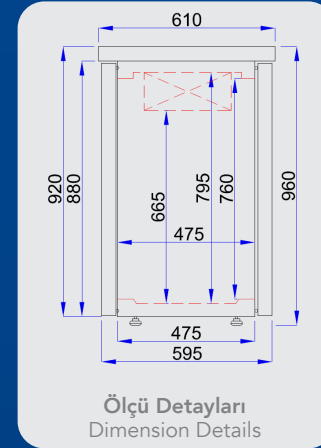

SSN3-61-2-SH



Bar Line Series

Çekmece Seçenekleri / Drawer Options



SSN3-5D-G

G Cam Kapı - Glass Door 244 €

Çekmeceler Sadece Üretim Aşamasında Takılabilir
Drawer Option is Only Possible During Production

Bilgi



- * Dış Gövde Siyah PVC Kaplı Galvaniz Sac
- * 35-40 Kg/m³ Çevre Dostu HCFC İçermeyen Poliüretan İzolasyon
- * Fanlı Soğutma
- * Dijital Termometre & Termostat
- * Otomatik Defrost
- * Kapılarda Kilit
- * Yüksekliği Ayarlanabilir Ayaklar
- * Özel, Kapı Menteşe Sistemi
- * Temizlenebilir ve Sökülebilir Manyetik Kapı Contası
- * Plastik Kaplı Çelik Raf
- * Dış Ortam Sıcaklığı: + 32°C

Info

- * Outside Body Black PVC Coated Galvanized Sheet
- * 35-40 Kg/m³ Ecology Friendly HCFC Free Polyurethane Insulation
- * Fan Cooling
- * Digital Thermometer & Thermostat
- * Automatic Defrost
- * Locks on Each Door
- * Legs Adjustable For Height
- * Special Door and Hinge Systems
- * Removable and Easy Cleaning Magnetic Gaskets
- * Plastic Coated Steel Shelf
- * Ambient Temperature: + 32°C

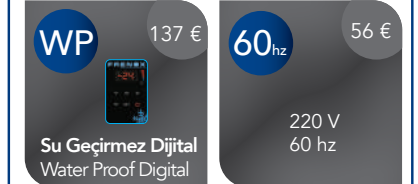
Kod Özellikleri Available Codes



Model Models	İç Sıcaklık Temperature °C	Brüt Hacim Gross volume Lt.	Ölçüler Dimensions Cm.	Paket Ölçüsü Packing Dim. Cm.	Ağırlık Weight Kg.	Paslanmaz Özelliği Stainless Steel Type
 SSN2-61-2-SH	-2/+8	320	138x61x96	148x71x116	170	Outside: Black Inside: 430
 SSN3-61-2-SH	-2/+8	500	194x 61x96	204x71x116	180	Outside: Black Inside: 430
 SSN4-61-2-SH	-2/+8	680	249x61x96	259x71x116	200	Outside: Black Inside: 430

İzolasyon Kalınlığı Insulation Thickness	Raf Adedi Shelf Unit	Soğutma Gazı Cooling Gas	Voltaj Voltage	Enerji Sınıfı Energy Rating	Fiyat Price €	Model Models	Fiyat Price
60 mm	4	R134A	220 V / 50 Hz	D	2.748 €	SSN2-61-2-SH	2.737 €
60 mm	6	R134A	220 V / 50 Hz	D	3.596 €	SSN3-61-2-SH	3.586 €
60 mm	8	R134A	220 V / 50 Hz	D	4.275 €	SSN4-61-2-SH	4.265 €

Şişe Soğutucu 1 Kapılı

Bottle Coolers 1 Door



SB300

Option : 189 €

115 V / 60 Hz

41 Adet Raf
Kapasitesi.
2,5 cm Aralıklı.
41 Unit Shelf
Holder Capacity.
2,5 cm Spaced.



FRENOX
PROFESSIONAL REFRIGERATION

Bar Line Series

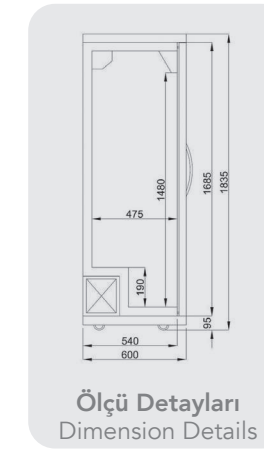

Ölçü Detayları
Dimension Details



SS300

Bilgi

- * 35-40 Kg/m³ Çevre Dostu HCFC İçermeyen Poliüretan İzolasyon
- * Enerji Tasarruflu LED Aydınlatma
- * Fanlı Soğutma
- * Dijital Termometre & Termostat
- * Otomatik Defrost
- * Kapılarda Kilit
- * Yüksekliği Ayarlanabilir Ayaklar
- * Özel, Kapı Menteşe Sistemi
- * Temizlenebilir ve Sökülebilir Manyetik Kapı Contası
- * Plastik Kaplı Çelik Raf
- * Dış Ortam Sıcaklığı: + 32°C

Info

- * 35-40 Kg/m³ Ecology Friendly HCFC Free Polyurethane Insulation
- * Energy Saving LED Lighting
- * Fan Cooling
- * Digital Thermometer & Thermostat
- * Automatic Defrost
- * Locks on Each Door
- * Legs Adjustable For Height
- * Special Door and Hinges System
- * Removable and Easy Cleaning Magnetic Gaskets
- * Plastic Coated Steel Shelf
- * Ambient Temperature: + 32°C

Kod Özellikleri



Available Codes

Raf ve Raf Kızağı
Shelf and
Shelf
Holder 49 €

BT
Wi-Fi Dijital
Wi-Fi Digital 418 €

L
Sol Kapı
(Dikey)
Left Door
(Upright) 30 €

60_{hz}
220 V
60 hz 56 €

Model Models	İç Sıcaklık Temperature °C	Brüt Hacim Gross volume Lt.	Ölçüler Dimensions Cm.	Paket Ölçüsü Packing Dim. Cm.	Ağırlık Weight Kg.	Paslanmaz Özelliği Stainless Steel Type
 SB300	+2/+12	400	60x66x183,5	65x72x200	120	Out Side : Black In Side : 430
 SS300	+2/+12	400	60x66x183,5	65x72x200	120	430

İzolasyon Kalınlığı Insulation Thickness	Raf Adedi Shelf Unit	Soğutma Gazı Cooling Gas	Voltaaj Voltage	Kapı Adedi Door Unit	Fiyat Price €	Model Models	Fiyat Price
50 mm	4	R134A	220 V / 50 Hz	1	2.324 €	SB300-R290	2.297 €
50 mm	4	R134A	220 V / 50 Hz	1	2.440 €	SS300-R290	2.414 €

Bar Buzdolapları / PVC Kaplı Gövde

Bar Refrigerators / PVC Coated Body

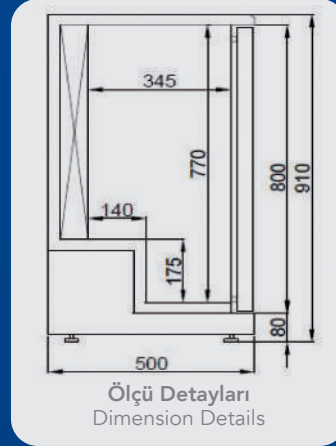

Option : 189 €

115 V / 60 Hz

Özel Önden Hava Alma Özelliği
Special Front Air Inlet Feature



BB350



Bar Line Series



BB250SL



BB150-SS

Kod Özellikleri

Available Codes

1 Kapı / 1 Door Raf ve Raf Dikmesi Shelf and Shelf Holder	42 €	2 Kapı / 2 Door Raf ve Raf Dikmesi Shelf and Shelf Holder	56 €
---	------	---	------

3 Kapı / 3 Door Raf ve Raf Dikmesi Shelf and Shelf Holder	78 €	R134a	178 €
---	------	-------	-------

60hz	56 €
------	------

Bilgi

- * 35-40 Kg/m³ Çevre Dostu HCFC İçermeyen Poliüretan İzolasyon
- * Enerji Tasarruflu LED Aydınlatma
- * Fanlı Soğutma
- * Dijital Termometre & Termostat
- * Otomatik Defrost
- * Kapılarda Kilit
- * Yüksekliği Ayarlanabilir Ayaklar
- * Özel, Kapı Menteşe Sistemi
- * Temizlenebilir ve Sökülebilir Manyetik Kapı Contası
- * Plastik Kaplı Çelik Raf
- * Dış Ortam Sıcaklığı: + 32°C
- * SS Modellerde : Kapı ve Alt Panel Paslanmaz

Info

- * 35-40 Kg/m³ Ecology Friendly HCFC Free Polyurethane Insulation
- * Energy Saving LED Lighting
- * Fan Cooling
- * Digital Thermometer & Thermostat
- * Automatic Defrost
- * Locks on Each Door
- * Legs Adjustable For Height
- * Special Door and Hinge Systems
- * Removable and Easy Cleaning Magnetic Gaskets
- * Plastic Coated Steel Shelf
- * Ambient Temperature: + 32°C
- * SS Models : Door + Lower Panel in Stainless Steel

Model Models	İç Sıcaklık Temperature °C	Brüt Hacim Gross volume Lt.	Ölçüler Dimensions Cm.	Paket Ölçüsü Packing Dim. Cm.	Ağırlık Weight Kg.	
	BB150-R290	+2/+12	110	59,5x50x91	70x60x105	63
	BB150SS-R290	+2/+12	110	59,5x50x91	70x60x105	68
	BB250-R290	+2/+12	210	92x50x91	102x60x105	91
	BB250SS-R290	+2/+12	210	92x50x91	102x60x105	94
	BB250SL-R290	+2/+12	210	92x50x91	102x60x105	91
	BB350-R290	+2/+12	310	138x50x91	150x60x105	126
	BB350SS-R290	+2/+12	310	138x50x91	150x60x105	129
	BB350SL-R290	+2/+12	310	138x50x91	150x60x105	129

SL : Sürgü Cam Kapı / SL : Sliding Glas Door

Paslanmaz Özelliği Stainless Steel Type	İzolasyon Kalınlığı Insulation Thickness	Raf Adedi Shelf Unit	Soğutma Gazı Cooling Gas	Volтаж Voltage	Fiyat Price €
Dış Gövde / Out Side :Siyah/Black İç Gövde / Inside : Gri / Gray	30 mm	2	R290	220 V / 50 Hz	1.199 €
Dış Gövde / Out Side :Siyah/Black İç Gövde / Inside : Gri / Gray	30 mm	2	R290	220 V / 50 Hz	1.305 €
Dış Gövde / Out Side :Siyah/Black İç Gövde / Inside : Gri / Gray	30 mm	2	R290	220 V / 50 Hz	1.549 €
Dış Gövde / Out Side :Siyah/Black İç Gövde / Inside : Gri / Gray	30 mm	2	R290	220 V / 50 Hz	1.761 €
Dış Gövde / Out Side :Siyah/Black İç Gövde / Inside : Gri / Gray	30 mm	2	R290	220 V / 50 Hz	1.867 €
Dış Gövde / Out Side :Siyah/Black İç Gövde / Inside : Gri / Gray	30 mm	2	R290	220 V / 50 Hz	2.111 €
Dış Gövde / Out Side :Siyah/Black İç Gövde / Inside : Gri / Gray	30 mm	2	R290	220 V / 50 Hz	2.429 €
Dış Gövde / Out Side :Siyah/Black İç Gövde / Inside : Gri / Gray	30 mm	2	R290	220 V / 50 Hz	2.493 €

SS : Kapı ve Ön Kanopi Paslanmaz / SS : Front and Doors are Stainless Steel

Bar Buzdolapları / Paslanmaz Gövde

Bar Refrigerators / Stainless Steel Body



Bar Line Series

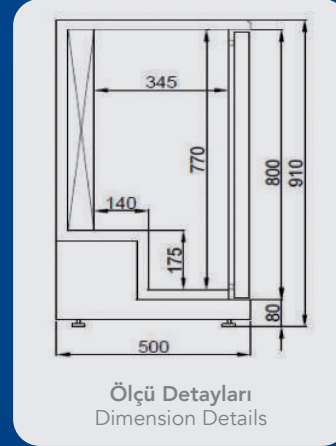

Option : 189 €

115 V / 60 Hz

Özel Önden
Hava Alma
Özelliği
Special Front
Air Inlet
Feature



SS350



SS150



SS250

Kod Özellikleri Available Codes

1 Kapı / 1 Door Raf ve Raf Dikmesi Shelf and Shelf Holder	42 €	2 Kapı / 2 Door Raf ve Raf Dikmesi Shelf and Shelf Holder	56 €
---	------	---	------

3 Kapı / 3 Door Raf ve Raf Dikmesi Shelf and Shelf Holder	78 €	R134a 178 € R134a
---	------	-------------------------



60 hz	56 €
220 V 60 hz	

Bilgi

- * 35-40 Kg/m³ Çevre Dostu HCFC İçermeyen Poliüretan İzolasyon
- * Enerji Tasarruflu LED Aydınlatma
- * Fanlı Soğutma
- * Dijital Termometre & Termostat
- * Otomatik Defrost
- * Kapılarda Kilit
- * Yüksekliği Ayarlanabilir Ayaklar
- * Özel, Kapı Menteşe Sistemi
- * Temizlenebilir ve Sökülebilir Manyetik Kapı Contası
- * Plastik Kaplı Çelik Raf
- * Dış Ortam Sıcaklığı: + 32°C

Info

- * 35-40 Kg/m³ Ecology Friendly HCFC Free Polyurethane Insulation
- * Energy Saving LED Lighting
- * Fan Cooling
- * Digital Thermometer & Thermostat
- * Automatic Defrost
- * Locks on Each Door
- * Legs Adjustable For Height
- * Special Door and Hinge Systems
- * Removable and Easy Cleaning Magnetic Gaskets
- * Plastic Coated Steel Shelf
- * Ambient Temperature: + 32°C

Model Models	İç Sıcaklık Temperature °C	Brüt Hacim Gross volume Lt.	Ölçüler Dimensions Cm.	Paket Ölçüsü Packing Dim. Cm.	Ağırlık Weight Kg.
 SS150-R290	+2/+12	110	59,5x50x91	70x60x105	63
 SS250-R290	+2/+12	210	92x50x91	102x60x105	95
 SS350-R290	+2/+12	310	138x50x91	150x60x105	123

Paslanmaz Özelliği Stainless Steel Type	İzolasyon Kalınlığı Insulation Thickness	Raf Adedi Shelf Unit	Soğutma Gazı Cooling Gas	Voltaj Voltage	Fiyat Price €
430	30 mm	2	R290	220 V / 50 Hz	1.538 €
430	30 mm	2	R290	220 V / 50 Hz	1.899 €
430	30 mm	2	R290	220 V / 50 Hz	2.440 €

Bar Buzdolapları / Paslanmaz Gövde

Bar Refrigerators / Stainless Steel Body

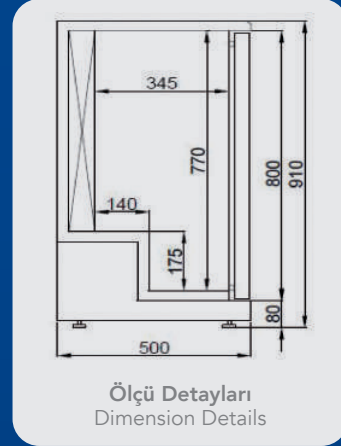

Option : 189 €

115 V / 60 Hz



ST250

Özel Önden
Hava Alma
Özelliği
Special Front
Air Inlet
Feature



FRENOX
PROFESSIONAL REFRIGERATION

Bar Line Series



ST250



ST350

Kod Özellikleri Available Codes

1 Kapı /
1 Door
Raf ve
Raf
Dikmesi
Shelf and
Shelf Holder

42 €

2 Kapı /
2 Door
Raf ve
Raf
Dikmesi
Shelf and
Shelf Holder

56 €

3 Kapı /
3 Door
Raf ve
Raf
Dikmesi
Shelf and
Shelf Holder

78 €

R134a
R134a

178 €

60
hz

56 €



220 V
60 Hz

Bilgi

- * 35-40 Kg/m³ Çevre Dostu HCFC İçermeyen Poliüretan İzolasyon
- * Enerji Tasarruflu LED Aydınlatma
- * Fanlı Soğutma
- * Dijital Termometre & Termostat
- * Otomatik Defrost
- * Kapılarda Kilit
- * Yüksekliği Ayarlanabilir Ayaklar
- * Özel, Kapı Menteşe Sistemi
- * Temizlenebilir ve Sökülebilir Manyetik Kapı Contası
- * Plastik Kaplı Çelik Raf
- * Dış Ortam Sıcaklığı: + 32°C

Info

- * 35-40 Kg/m³ Ecology Friendly HCFC Free Polyurethane Insulation
- * Energy Saving LED Lighting
- * Fan Cooling
- * Digital Thermometer & Thermostat
- * Automatic Defrost
- * Locks on Each Door
- * Legs Adjustable For Height
- * Special Door and Hinge Systems
- * Removable and Easy Cleaning Magnetic Gaskets
- * Plastic Coated Steel Shelf
- * Ambient Temperature: + 32°C

Model Models	İç Sıcaklık Temperature °C	Brüt Hacim Gross volume Lt.	Ölçüler Dimensions Cm.	Paket Ölçüsü Packing Dim. Cm.	Ağırlık Weight Kg.
 ST150-R290	+2/+12	110	59,5x50x91	70x60x105	30
 ST250-R290	+2/+12	210	92x50x91	102x60x105	42
 ST350-R290	+2/+12	310	138x50x91	150x60x105	52

Paslanmaz Özelliği Stainless Steel Type	İzolasyon Kalınlığı Insulation Thickness	Raf Adedi Shelf Unit	Soğutma Gazı Cooling Gas	Voltaj Voltage	Fiyat Price €
430	30 mm	2	R290	220 V / 50 Hz	1.528 €
430	30 mm	2	R290	220 V / 50 Hz	1.812 €
430	30 mm	2	R290	220 V / 50 Hz	2.334 €

Bar Buzdolapları - Bardak Soğutucu

Bar Refrigerators - Glass Frosters



Bar Line Series

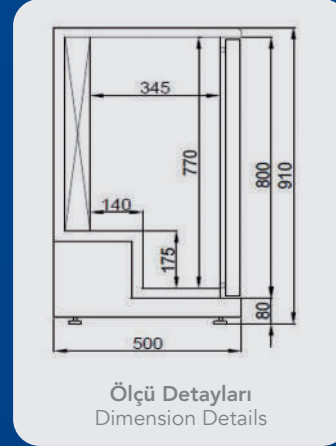

Option : 189 €

115 V / 60 Hz



SL-150-G



SL-150

Bilgi

- * 35-40 Kg/m³ Çevre Dostu HCFC İçermeyen Poliüretan İzolasyon
- * Enerji Tasarruflu LED Aydınlatma
- * Fanlı Soğutma
- * Dijital Termometre & Termostat
- * Otomatik Defrost
- * Kapılarda Kilit
- * Yüksekliği Ayarlanabilir Ayaklar
- * Özel, Kapı Mentеше Sistemi
- * Temizlenebilir ve Sökülebilir Manyetik Kapı Contası
- * Plastik Kaplı Çelik Raf
- * Dış Ortam Sıcaklığı: + 32°C

Info



- * 35-40 Kg/m³ Ecology Friendly HCFC Free Polyurethane Insulation
- * Energy Saving LED Lighting
- * Fan Cooling
- * Digital Thermometer & Thermostat
- * Automatic Defrost
- * Locks on Each Door
- * Legs Adjustable For Height
- * Special Door and Hinge Systems
- * Removable and Easy Cleaning Magnetic Gaskets
- * Plastic Coated Steel Shelf
- * Ambient Temperature: + 32°C

Kod Özellikleri

Available Codes

Raf ve Raf Kızağı Shelf and Shelf Holder	49 €	60 ^{hz}	56 €
		220 V	60 hz

SL-150-G

Model Models	İç Sıcaklık Temperature °C	Brüt Hacim Gross volume Lt.	Standart Ölçüler Standart Dimensions Cm.	Paket Ölçüsü Packing Dim. Cm.	Ağırlık Weight Kg.	Paslanmaz Özelliği Stainless Steel Type
 SL-150-G	-10/-15	150	59,5x50x91	69,5x60x101	72	430
 SL-150	-10/-15	150	59,5x50x91	69,5x60x101	68	430

İzolasyon Kalınlığı Insulation Thickness	Raf Adedi Shelf Unit	Soğutma Gazı Cooling Gas	Voltaj Voltage	Fiyat Price €	Model Models	Fiyat Price
30 mm	1	R404A	220 V / 50 Hz	2.633 €	SL-150-G-R290	2.606 €
30 mm	1	R404A	220 V / 50 Hz	2.202 €	SL-150-R290	2.176 €

Tezgahaltı Slim Buzdolapları

Slim Refrigerators



Bar Line Series

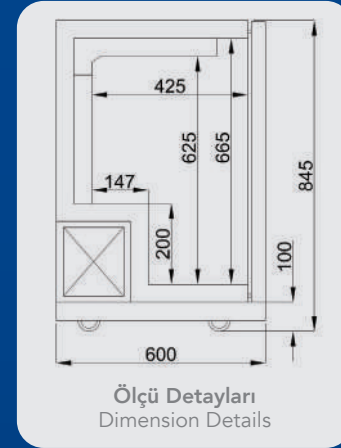

Option : 189 €

115 V / 60 Hz



Dondurma Saklama Opsiyonu
Ice Cream Storage Option

704 €

Cam kapakta mevcut değildir.
Not available in glass door.



BSN1



BSN1-G

Bilgi

- * 35-40 Kg/m³ Çevre Dostu HCFC İçermeyen Poliüretan İzolasyon
- * Fanlı Soğutma
- * Dijital Termometre & Termostat
- * Otomatik Defrost
- * Yüksekliği Ayarlanabilir Ayaklar
- * Özel, Kapı Menteşe Sistemi
- * Temizlenebilir ve Sökülebilir Manyetik Kapı Contası
- * Plastik Kaplı Çelik Raf
- * Dış Ortam Sıcaklığı: + 43°C

Info

- * 35-40 Kg/m³ Ecology Friendly HCFC Free Polyurethane Isolation
- * Fan Cooling
- * Digital Thermometer & Thermostat
- * Automatic Defrost
- * Legs Adjustable For Height
- * Special Door and Hinge Systems
- * Removable and Easy Cleaning Magnetic Gaskets
- * Plastic Coated Steel Shelf
- * Ambient Temperature: + 43°C

Kod Özellikleri

Available Codes

Raf ve Raf Kızağı
Shelf and Shelf Holder

49 €

60hz

56 €

220 V
60 hz





K

70 €



Kilitli Kapı
With Lock

BSN1

Model Models	İç Sıcaklık Temperature °C	Brüt Hacim Gross volume Lt.	Ölçüler Dimensions Cm.	Paket Ölçüsü Packing Dim. Cm.	Ağırlık Weight Kg.	Paslanmaz Özellikli Stainless Steel Type
 BSN1	-2/+8	110	60x60x84,5	65x65x103	68	430
 BSL1	-10/-15	110	60x60x84,5	65x65x103	75	430
 BSN1-G	-2/+8	110	60x60x84,5	65x65x103	68	430
 BSL1-G	-10/-15	110	60x60x84,5	65x65x103	75	430

İzolasyon Kalınlığı Insulation Thickness	Raf Adedi Shelf Unit	Soğutma Gazı Cooling Gas	Voltaj Voltage	Fiyat Price €
50 mm	1	R134A	220 V / 50 Hz	1.435 €
50 mm	1	R404A	220 V / 50 Hz	1.647 €
50 mm	1	R134A	220 V / 50 Hz	1.716 €
50 mm	1	R404A	220 V / 50 Hz	2.633 €

Model Models	Fiyat Price €
BSN1-R290	1.408 €
BSL1-R290	1.620 €
BSN1-G-R290	1.690 €
BSL1-G-R290	2.606 €

Kokteyl Tezgahı

Cocktail Refrigerator



FRENOX
PROFESSIONAL REFRIGERATION

Bar Line Series

Çekmece Seçenekleri / Drawer Options



1D 1/1 Çekmece - 1/1 Drawers 328 €

2D 1/2 Çekmece - 1/2 Drawers 431 €

1/2 Çekmecelerde kapı kilidi yoktur.
1/2 drawers don't have lock option.

CKT2-3D-WK-WP

Bilgi

- * İç Derinlik: 43 Cm / 53 Cm (GN 1/1 Kapasiteli)
- * 35-40 Kg/m³ Çevre Dostu HCFC İçermeyen Poliüretan İzolasyon
- * Dijital Kumanda Paneli
- * Elektrik Rezistanslı Otomatik Defrost
- * Özel Su Buharlaştırma Sistemi
- * Yüksekliği Ayarlanabilir Paslanmaz Ayaklar
- * Özel, Kapı Menteşe Sistemi
- * Temizlenebilir ve Sökülebilir Manyetik Kapı Contası
- * Dış Ortam Sıcaklığı: + 43°C & % 65 Nem

Info

- * Inside Depth: 43 Cm / 53 Cm (GN 1/1 Capacity)
- * 35-40 Kg/m³ Ecology Friendly HCFC Free Polyurethane Insulation
- * Digital Control Panel
- * Electrical Resistor Automatic Defrost
- * Special Water Evaporation
- * Stainless Steel Legs Adjustable For Height
- * Special Door and Hinge Systems
- * Removable and Easy Cleaning Magnetic Gaskets
- * Ambient Temperature: + 43°C %65 Humidity

Kod Özellikleri

Available Codes

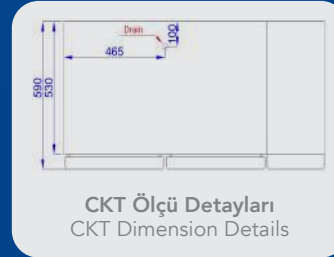
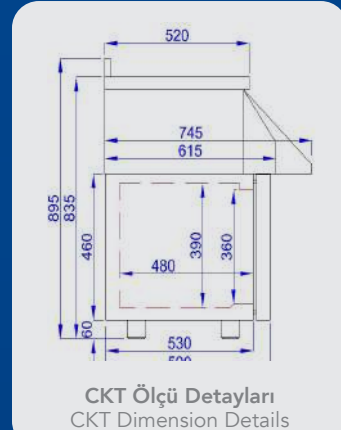
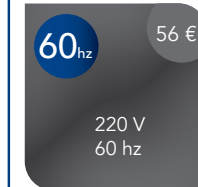

Option : 189 €



115 V / 60 Hz

Değişebilir Yükseklik
Adjustable Height **189 €**



CKT2-W-K-WP

Standart Yükseklik: 85 cm Min. Yükseklik: 89 cm
Standard Height: 85 cm Min. Height: 89 cm

Model Models	İç Sıcaklık Temperature °C	Brüt Hacim Gross volume Lt.	Standart Ölçüler Standart Dimensions Cm.	Paket Ölçüsü Packing Dim. Cm.	Ağırlık Weight Kg.	Paslanmaz Özelliği Stainless Steel Type
 CKT2-W-K-WP	-2/+8	150	120x60x85	130x70x100	110	304
 CKT3-W-K-WP	-2/+8	235	160x60x85	170x70x100	150	304

İzolasyon Kalınlığı Insulation Thickness	Raf Adedi Shelf Unit	Soğutma Gazı Cooling Gas	Voltaj Voltage	Enerji Sınıfı Energy Rating	Fiyat Price €	Model Models	Fiyat Price
50 mm	2	R134A	220 V / 50 Hz	-	5.052 €	CKT2-K-R290	5.024 €
50 mm	3	R134A	220 V / 50 Hz	-	6.087 €	CKT3-K-R290	6.060 €

Yatay Panel Buzdolabı - (Vakum Çekmece / Kapı İle)

Counter Panel Refrigerator - (With Vacuum Drawer / Door)



Çekmece Seçenekleri / Drawer Options

Bar Line Series



100 cm

Option : 189 €

115 V / 60 Hz

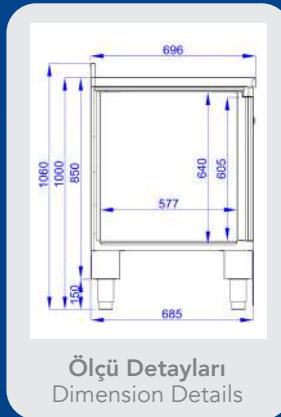

Ölçü Detayları
Dimension Details



Değişebilir Yükseklik
Adjustable Height

85 cm



GVN3-85-5D

TEZ2-85-GD-CD

Min. Yükseklik: 73 cm Standart Yükseklik: 85/100 cm
Min. Height: 73 cm Standard Height: 85/100 cm



3D 1/3 Çekmece - 1/3 Drawers 743 €
2D 1/2 Çekmece - 1/2 Drawers 552 €
1K 1/1 Kapı - 1/1 Door 191 €

Bilgi

- * İç Derinlik: 58 Cm
- * 35-40 Kg/m³ Çevre Dostu HCFC İçermeyen Poliüretan İzolasyon
- * Dijital Kumanda Paneli
- * Elektrik Rezistanslı Otomatik Defrost
- * Özel Su Buharlaştırma Sistemi
- * Yüksekliği Ayarlanabilir Paslanmaz Ayaklar
- * Özel, Kapı Mentеше Sistemi
- * Temizlenebilir ve Sökülebilir Manyetik Kapı Contası
- * Dış Ortam Sıcaklığı: +32°C & %55 Nem

Info

- * Inside Depth: 58 Cm
- * 35-40 Kg/m³ Ecology Friendly HCFC Free Polyurethane Insulation
- * Digital Control Panel
- * Electrical Resistor Automatic Defrost
- * Special Water Evaporation
- * Stainless Steel Legs Adjustable For Height
- * Special Door and Hinge Systems
- * Removable and Easy Cleaning Magnetic Gaskets
- * Ambient Temperature: + 32°C %55 Humidity

Kod Özellikleri / Available Codes

MI + %15 Ayna Sacı Gövdesi Mirror Body	60hz 56 € 220 V 60 hz
DZ 0 € Düz Üst Tabla Straight Work Top	GR 2 Door 858 € 3 Door 1057 € 4 Door 1374 € Granit Üst Tabla Granite Work Top
MR 2 Door 418 € 3 Door 531 € 4 Door 727 € Mermer Üst Tabla Marble Work Top	PL 2 Door 780 € 3 Door 1014 € 4 Door 1316 € Polietilen Üst Tabla Polyethylene Work Top
F 2 Door -109 € 3 Door -139 € 4 Door -182 € Üst Tablasız Without Work Top	DKP 30 € Dijital Koruma Plastiği Digital Cover

Model Models	İç Sıcaklık Temperature °C	Brüt Hacim Gross volume Lt.	Ölçüler Dimensions Cm.	Paket Ölçüsü Packing Dim. Cm.	Ağırlık Weight Kg.	Paslanmaz Özelligi Stainless Steel Type
	GVN2-85	-2/+8	143x70x85	153x80x105	160	430
	GVN2-100	-2/+8	143x70x100	153x80x120	170	430
	GVN3-85	-2/+8	191x70x85	200x80x105	190	430
	GVN3-100	-2/+8	191x70x100	200x80x120	200	430
	GVN4-85	-2/+8	238x70x85	248x80x105	220	430
	GVN4-100	-2/+8	238x70x100	248x80x120	230	430

İzolasyon Kalınlığı Insulation Thickness	Raf Adedi Shelf Unit	Soğutma Gazı Cooling Gas	Voltaj Voltage	Enerji Sınıfı Energy Rating	Fiyat Price €	Model Models	Fiyat Price
50 mm	2	R134A	220 V / 50 Hz	E	2.254 €	GVN2-85-R290	2.228 €
50 mm	2	R134A	220 V / 50 Hz	E	2.361 €	GVN2-100-R290	2.334 €
50 mm	3	R134A	220 V / 50 Hz	E	2.679 €	GVN3-85-R290	2.652 €
50 mm	3	R134A	220 V / 50 Hz	E	2.785 €	GVN3-100-R290	2.758 €
50 mm	6	R134A	220 V / 50 Hz	E	3.315 €	GVN4-85-R290	3.289 €
50 mm	6	R134A	220 V / 50 Hz	E	3.421 €	GVN4-100-R290	3.395 €

WP 137 €
Su Geçirmez Dijital
Water Proof Digital

BT 418 €
Wi-Fi Dijital
Wi-Fi Digital

159 €
Yan Kapama Sacı
Side Covering Sheet

Yatay Panel Nötr Dolap - 70 cm

Counter Panel Neutral Cabinet - 70 cm



GEZ3-100-5D

100 cm

Option : 189 €

115 V / 60 Hz

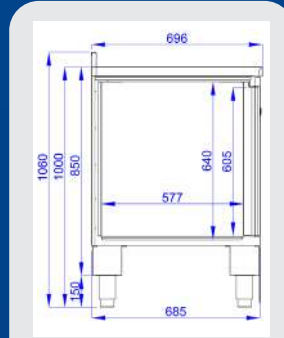

Ölçü Detayları
Dimension Details

Değişebilir Yükseklik
Adjustable Height

85 cm



GEZ2-85-GD-CD

GEZ3-85-5D

Tamamı izole alt taban
maksimum hijyen
sağlamaktadır

All closed bottom
stainless steel part produces
maximum hygiene

Min. Yükseklik: 73 cm Standart Yükseklik: 85/100 cm
Min. Height: 73 cm Standard Height: 85/100 cm



Bar Line Series

Çekmece Seçenekleri / Drawer Options



- GD** Çöp Çekmecesi - GARBAGE DRAWERS 508 €
- CD** Kahve Çekmecesi - COFFEA DRAWERS 337 €
- 3D** 1/3 Çekmece - 1/3 Drawers 743 €
- 2D** 1/2 Çekmece - 1/2 Drawers 552 €
- 1D** 1/1 Çekmece - 1/1 Drawers 191 €

Kod Özellikleri
Available Codes

F 2 Door -109 €
3 Door -139 €
4 Door -182 €

MI + %15
Ayna Sacı Gövdesi
Mirror Body

Üst Tablasız
Without Work Top

DZ 0 €
Düz Üst Tabla
Straight Work Top

GR 2 Door 858 €
3 Door 1057 €
4 Door 1374 €
Granit Üst Tabla
Granite Work Top

MR 2 Door 418 €
3 Door 531 €
4 Door 727 €
Mermer Üst Tabla
Marble Work Top

PL 2 Door 780 €
3 Door 1014 €
4 Door 1316 €
Polietilen Üst Tabla
Polyethylene Work Top

159 €
Yan Kapama Sacı
Side Covering Sheet

Bilgi

- * İç Derinlik: 58 Cm
- * 35-40 Kg/m³ Çevre Dostu HCFC İçermeyen Poliüretan İzolasyon
- * Yüksekliği Ayarlanabilir Paslanmaz Ayaklar
- * Özel, Kapı Menteşe Sistemi
- * Temizlenebilir ve Sökülebilir Manyetik Kapı Contası

Info

- * Inside Depth: 58 Cm
- * 35-40 Kg/m³ Ecology Friendly HCFC Free Polyurethane Insulation
- * Stainless Steel Legs Adjustable For Height
- * Special Door and Hinge Systems
- * Removable and Easy Cleaning Magnetic Gaskets

Model Models	İç Sıcaklık Temperature °C	Brüt Hacim Gross volume Lt.	Ölçüler Dimensions Cm.	Paket Ölçüsü Packing Dim. Cm.	Ağırlık Weight Kg.	Paslanmaz Özelligi Stainless Steel Type
	GEZ2-85	240	102x70x85	112x80x105	120	430
	GEZ2-100	240	102x70x100	112x80x120	125	430
	GEZ3-85	360	150x70x85	160x80x105	150	430
	GEZ3-100	360	150x70x100	160x80x120	155	430
	GEZ4-85	480	197x70x85	207x80x105	180	430
	GEZ4-100	480	197x70x100	207x80x120	185	430

İzolasyon Kalınlığı Insulation Thickness	Raf Adedi Shelf Unit	Soğutma Gazı Cooling Gas	Voltaj Voltage	Enerji Sınıfı Energy Rating	Fiyat Price €
50 mm	2	-	-	-	1.772 €
50 mm	2	-	-	-	1.878 €
50 mm	3	-	-	-	2.313 €
50 mm	3	-	-	-	2.419 €
50 mm	4	-	-	-	2.886 €
50 mm	4	-	-	-	2.992 €

Yatay Panel Buzdolabı - (Vakum Çekmece / Kapı İle)

Counter Panel Refrigerator - (With Vacuum Drawer / Door)



Çekmece Seçenekleri / Drawer Options

Bar Line Series



100 cm

Option : 189 €

115 V / 60 Hz

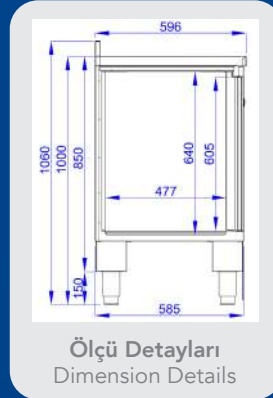

Ölçü Detayları
Dimension Details



3D 1/3 Çekmece - 1/3 Drawers 743 €

2D 1/2 Çekmece - 1/2 Drawers 552 €

1K 1/1 Kapı - 1/1 Door 191 €

Kod Özellikleri Available Codes

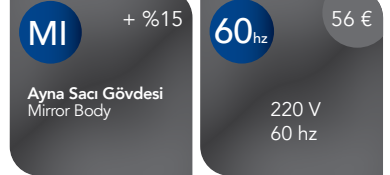

Değişebilir Yükseklik
Adjustable Height

85 cm



BVN3-85-5D

TEZ2-85-GD-CD

Min. Yükseklik: 73 cm Standart Yükseklik: 85/100 cm
Min. Height: 73 cm Standard Height: 85/100 cm

Bilgi

- * İç Derinlik: 48 Cm
- * 35-40 Kg/m³ Çevre Dostu HCFC İçermeyen Poliüretan İzolasyon
- * Dijital Kumanda Paneli
- * Elektrik Rezistanslı Otomatik Defrost
- * Özel Su Buharlaştırma Sistemi
- * Yüksekliği Ayarlanabilir Paslanmaz Ayaklar
- * Özel, Kapı Mentеше Sistemi
- * Temizlenebilir ve Sökülebilir Manyetik Kapı Contası
- * Dış Ortam Sıcaklığı: +32°C & %55 Nem

Info

- * Inside Depth: 58 Cm
- * 35-40 Kg/m³ Ecology Friendly HCFC Free Polyurethane Insulation
- * Digital Control Panel
- * Electrical Resistor Automatic Defrost
- * Special Water Evaporation
- * Stainless Steel Legs Adjustable For Height
- * Special Door and Hinge Systems
- * Removable and Easy Cleaning Magnetic Gaskets
- * Ambient Temperature: +32°C %55 Humidity

Model Models	İç Sıcaklık Temperature °C	Brüt Hacim Gross volume Lt.	Ölçüler Dimensions Cm.	Paket Ölçüsü Packing Dim. Cm.	Ağırlık Weight Kg.	Paslanmaz Özelliği Stainless Steel Type
BVN2-85	-2/+8	281	143x60x85	153x70x105	150	430
BVN2-100	-2/+8	281	143x60x100	153x70x120	160	430
BVN3-85	-2/+8	474	190x60x85	200x70x105	180	430
BVN3-100	-2/+8	474	190x60x100	200x70x120	190	430
BVN4-85	-2/+8	632	238x60x85	248x70x105	210	430
BVN4-100	-2/+8	632	238x60x100	248x70x120	220	430

İzolasyon Kalınlığı Insulation Thickness	Raf Adedi Shelf Unit	Soğutma Gazı Cooling Gas	Voltaj Voltage	Enerji Sınıfı Energy Rating	Fiyat Price €	Model Models	Fiyat Price
50 mm	2	R134A	220 V / 50 Hz	E	2.201 €	BVN2-85-R290	2.175 €
50 mm	2	R134A	220 V / 50 Hz	E	2.307 €	BVN2-100-R290	2.281 €
50 mm	3	R134A	220 V / 50 Hz	E	2.573 €	BVN3-85-R290	2.546 €
50 mm	3	R134A	220 V / 50 Hz	E	2.679 €	BVN3-100-R290	2.652 €
50 mm	4	R134A	220 V / 50 Hz	E	3.209 €	BVN4-85-R290	3.183 €
50 mm	4	R134A	220 V / 50 Hz	E	3.315 €	BVN4-100-R290	3.289 €

Yatay Panel Nötr Dolap - 60 cm

Counter Panel Neutral Cabinet - 60 cm



100 cm

TEZ3-100-5D

Option : 189 €

115 V / 60 Hz

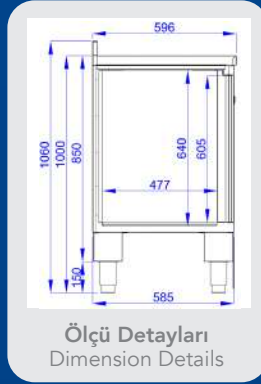

Ölçü Detayları
Dimension Details

Değişebilir Yükseklik
Adjustable Height



85 cm

TEZ3-85-5D

TEZ2-85-GD-CD

Tamamı izole alt taban maksimum hijyen sağlamaktadır

All closed bottom stainless steel part produces maximum hygiene

Min. Yükseklik: 73 cm Standart Yükseklik: 85/100 cm
Min. Height: 73 cm Standard Height: 85/100 cm



FRENOX
PROFESSIONAL REFRIGERATION

Bar Line Series

Çekmece Seçenekleri / Drawer Options



- GD** Çöp Çekmece - GARBAGE DRAWERS 508 €
- CD** Kahve Çekmece - COFFEE DRAWERS 337 €
- 3D** 1/3 Çekmece - 1/3 Drawers 743 €
- 2D** 1/2 Çekmece - 1/2 Drawers 552 €
- 1D** 1/1 Çekmece - 1/1 Drawers 191 €

Bilgi

- * İç Derinlik: 48 Cm
- * 35-40 Kg/m³ Çevre Dostu HCFC İçermeyen Poliüretan İzolasyon
- * Yüksekliği Ayarlanabilir Paslanmaz Ayaklar
- * Özel, Kapı Menteşe Sistemi
- * Temizlenebilir ve Sökülebilir Manyetik Kapı Contası

Info

- * Inside Depth: 48 Cm
- * 35-40 Kg/m³ Ecology Friendly HCFC Free Polyurethane Insulation
- * Stainless Steel Legs Adjustable For Height
- * Special Door and Hinge Systems
- * Removable and Easy Cleaning Magnetic Gaskets

Kod Özellikleri Available Codes

F 2 Door 109 €
3 Door 139 €
4 Door 182 €

MI + %15
Ayna Sacı Gövdesi
Mirror Body

Üst Tablasız
Without Work Top

DZ 0 €
Düz Üst Tabla
Straight Work Top

GR 2 Door 858 €
3 Door 1057 €
4 Door 1374 €
Granit Üst Tabla
Granite Work Top

MR 2 Door 418 €
3 Door 531 €
4 Door 727 €
Mermer Üst Tabla
Marble Work Top

PL 2 Door 780 €
3 Door 1014 €
4 Door 1316 €
Polietilen Üst Tabla
Polyethylene Work Top

159 €
Yan Kapama Sacı
Side Covering Sheet

Model Models	İç Sıcaklık Temperature °C	Brüt Hacim Gross volume Lt.	Ölçüler Dimensions Cm.	Paket Ölçüsü Packing Dim. Cm.	Ağırlık Weight Kg.	Paslanmaz Özelliği Stainless Steel Type
	TEZ2-85	240	102x60x85	112x70x105	110	430
	TEZ2-100	240	102x60x100	112x70x120	115	430
	TEZ3-85	360	150x60x85	160x70x105	140	430
	TEZ3-100	360	150x60x100	160x70x120	145	430
	TEZ4-85	480	197x60x85	207x70x105	170	430
	TEZ4-100	480	197x60x100	207x70x120	175	430

İzolasyon Kalınlığı Insulation Thickness	Raf Adedi Shelf Unit	Soğutma Gazı Cooling Gas	Voltaj Voltage	Enerji Sınıfı Energy Rating	Fiyat Price €
50 mm	2	-	-	-	1.750 €
50 mm	2	-	-	-	1.857 €
50 mm	3	-	-	-	2.281 €
50 mm	3	-	-	-	2.387 €
50 mm	4	-	-	-	2.854 €
50 mm	4	-	-	-	2.960 €

Özel Meşrubat Dolabı / PVC Kaplı Gövde

Special Beverage Refrigerator / PVC Coated Body



BG100



50 Db

Sessiz Çalışma Özelliği
Silent Operation Feature

318 €

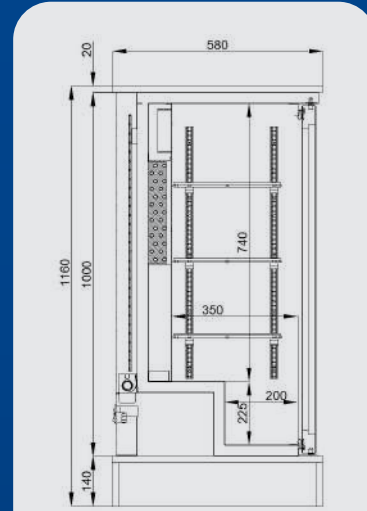

Ölçü Detayları
Dimension Details

Option : 189 €

115 V / 60 Hz



Bar Line Series

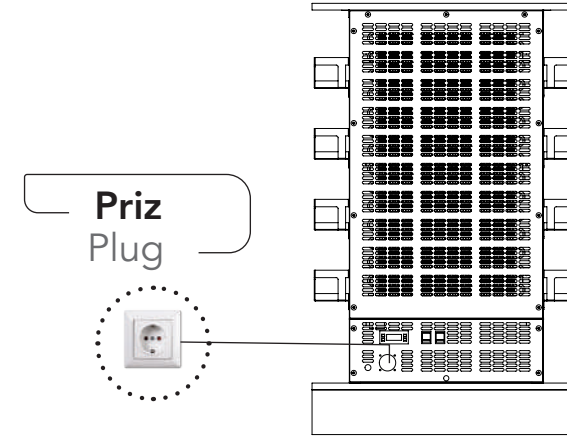

Arka Görünüm / Back View



BG100

Bilgi

- * 35-40 Kg/m³ Çevre Dostu HCFC İçermeyen Poliüretan İzolasyon
- * Fanlı Soğutma
- * Dijital Termometre & Termostat
- * Otomatik Defrost
- * Kapılarda Kilit
- * Özel, Kapı Mentеше Sistemi
- * Temizlenebilir ve Sökülebilir Manyetik Kapı Contası
- * Plastik Kaplı Çelik Raf
- * Dış Ortam Sıcaklığı: + 32°C
- * Ahşap Taban ve Tavan
- * Özel Bardak Tutucu Paslanmaz Raf

Info

- * 35-40 Kg/m³ Ecology Friendly HCFC Free Polyurethane Insulation
- * Fan Cooling
- * Digital Thermometer & Thermostat
- * Automatic Defrost
- * Locks on Each Door
- * Special Door and Hinge Systems
- * Removable and Easy Cleaning Magnetic Gaskets
- * Plastic Coated Steel Shelf
- * Ambient Temperature: + 32°C
- * Wood Floor and Ceiling
- * Special Stainless Steel Cup Holder

Model Models	İç Sıcaklık Temperature °C	Brüt Hacim Gross volume Lt.	Ölçüler Dimensions Cm.	Paket Ölçüsü Packing Dim. Cm.	Ağırlık Weight Kg.	Paslanmaz Özelliği Stainless Steel Type
 BG100	+2/+12	110	72x58x120	92x78x140	63	Dış Gövde / Out Side :Siyah/Black İç Gövde / Inside : Gri / Gray

İzolasyon Kalınlığı Insulation Thickness	Raf Adedi Shelf Unit	Soğutma Gazı Cooling Gas	Voltaj Voltage	Fiyat Price €
50 mm	3	R290	220 V / 50 Hz	2.108 €

176-178 **Özel Ölçüde Ankastre Ahşap Kaplama Şarap Buzdolabı**
Custom Size Built-In Wooden Cover Wine Cabinets



Şarap Buzdolapları
Wine Cabinets

178-180



181-183

Şarap Buzdolapları Çift Taraflı Kapı
Wine Cabinets Double Sided Doors



Şarap Buzdolapları Arkası Camlı
Wine Cabinets Back Side Glass

184-185



186-187

Şarap Buzdolapları Arkası Camlı
Wine Cabinets Back Side Glass



Özel Ölçüde Dry Age & Şarap Buzdolabı
Custom Size Dry Age & Wine Cabinets

188-189



190-191

Özel Ölçüde Camlı Şarap Buzdolabı
Custom Size Glass Wine Cabinets



192-193

Özel Ölçüde Camlı Şarap Buzdolabı
Custom size Glass Wine Cabinet



Özel Ölçüde Şarap Buzdolabı
Custom Size Wine Cabinets

194-195



196-197

Özel Ölçüde Dry-Age Buzdolabı
Custom Size Dry-Age



Özel Ölçüde Şarap Buzdolabı
Custom Size Wine Cabinets

198-199



200-201

Dry Age Buzdolapları
Dry Age Refrigerators



Dry Age Buzdolapları
Dry Age Refrigerators

202-203



204-205

Dry Age Buzdolapları
Dry Age Refrigerators



Dry Age Buzdolapları
Dry Age Refrigerators

206-207



208-209

Dry Age Buzdolapları
Dry Age Refrigerators



Özel Ölçüde Ankastré Ahşap Kaplama Şarap Buzdolabı

Custom Size Built-In Wooden Cover Wine Cabinets

Custom
Sizes
Options

Özel
Ölçü
Opsiyonu

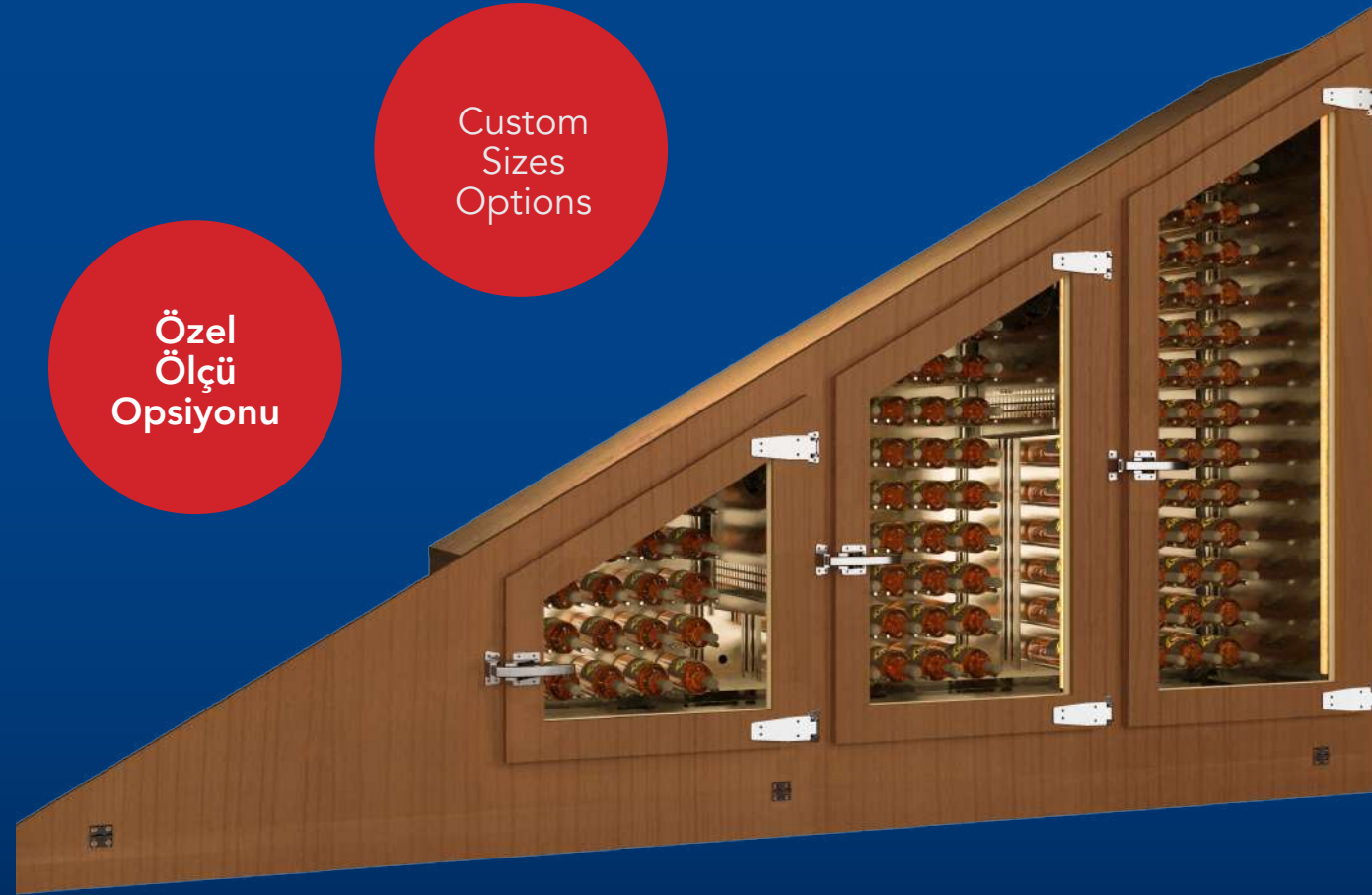

MRD10

Farklı Ahşap
Seçenekleri
Different Wooden
Options

1.175 €



FRENOX
PROFESSIONAL REFRIGERATION

Dry Age & Wine Refrigerators

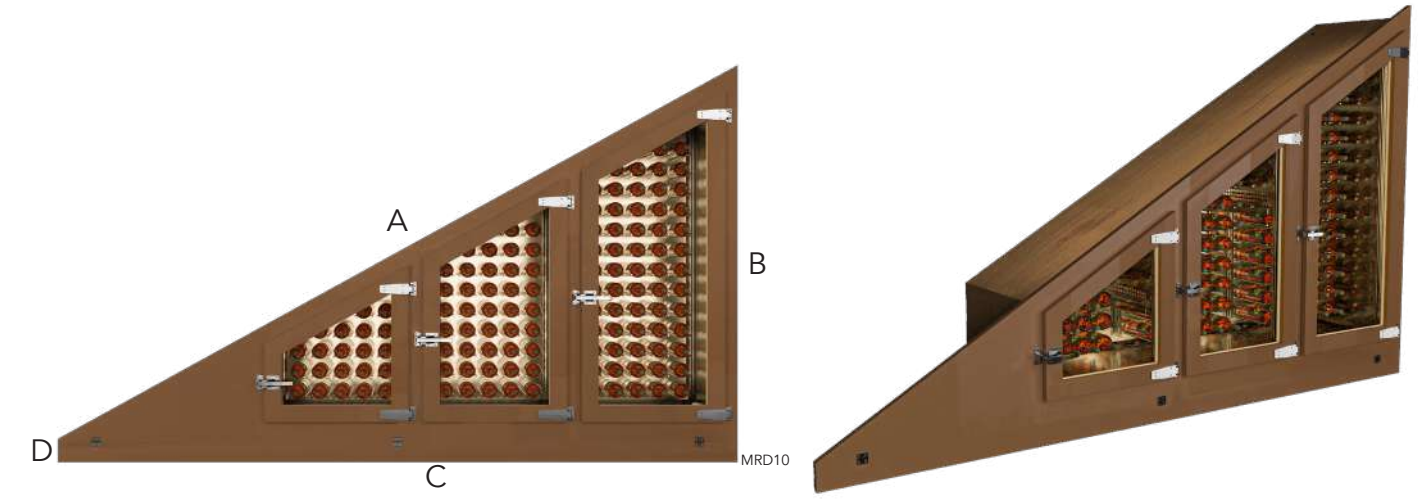

Bilgi

- * Projeye Göre Müşterinin İsteddiği Ölçülerde
- * Merdiven Altı Ankastré Özelliği
- * Aydınlatmalı LED Lamba
- * Kapıda Kilit
- * Şarap Saklama İçin Özel Raf
- * Özel Kapı ve Menteşe Sistemi
- * Temizlenebilir ve Sökülebilir Manyetik Kapı Contası
- * Dış Ortam Sıcaklığı + 30 °C & % 50 Nem
- * Sessiz Çalışma
- * Şarap İçin Üretilen Özel Teknoloji

Info

- * Custom Sizes Regarding to Customers Project
- * Built-In
- * LED Light
- * Door Lock
- * Special Railes Shelf System
- * Special Door and Hinge Systems
- * Removable and Easy Cleaning Magnetic Gasket
- * Ambient Temperature + 30 °C & % 50 Humidity
- * Minimum Noise while working
- * Specific Technology for Wine

Model Models	İç Sıcaklık Temperature °C	Brüt Hacim Gross volume Lt.	Ölçüler Dimensions Cm.	Paslanmaz Özelliği Stainless Steel Type
 MRD10	+4/+20 (Remote)	800	A= 349 B= 186 C= 302 D= 110 Projenize Uygun According to Your Project	Cam / Glass

İzolasyon Insulation	Raf Adedi Shelf Unit	Şişe Kapasitesi Bottle Capacity Lt.	Voltaj Voltage	Kapı Adedi Door Unit	Fiyat Price €	Soğutma Grubu Model Cooling Unit/Model	Fiyat Price
Ahşap Kaplama Wooden Cover	-	116 Projenize Uygun According to Your Project	220 V / 50 Hz	3 Projenize Uygun According to Your Project	7.957 €	 SPN1520 1HP (+4/+20)	3.752 €

* Soğutma grubu maksimum 5 metre uzaklığına göre hesaplanmıştır / Cooling groups can be installed max. 5 metres away from the refrigerator.

Şarap Buzdolapları Wine Cabinets



50 Db

Sessiz Çalışma Özelliği
Silent Operation Feature

318 €

Option : 189 €

Özel İki Dereceli Bölüm
Special Two Temperature Zone

115 V / 60 Hz

8 Adet Kayar Ahşap Raf.
11 cm Aralıklı.
8 Unit Wood Sliding Shelf
11 cm Spaced.

Her Raf 6 Şişe Alır.
Each Shelf Contains
6 Glasses

Ölçü Detayları
Dimension Details

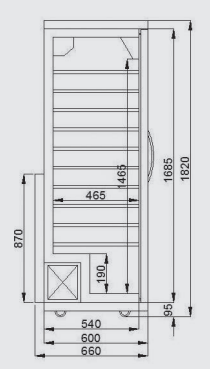

Dry Age & Wine Refrigerators

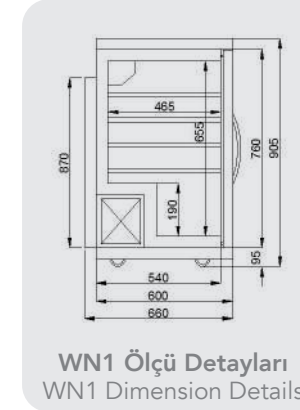

WN1 Ölçü Detayları
WN1 Dimension Details

WN1



WN4

Bilgi

- * İç Derinlik: 46,5 Cm
- * 35-40 Kg/m³ Çevre Dostu HCFC İçermeyen Poliüretan İzolasyon
- * Dijital Dokunmatik Kumanda Paneli
- * Ambianslı LED Aydınlatma
- * Kilitli Kapı
- * Otomatik Su Buharlaştırma Sistemi (Sıcak Gaz System)
- * Şarap Saklama İçin Özel Ahşap Raylı Raf
- * Özel Kapı ve Menteşe Sistemi
- * Temizlenebilir ve Sökülebilir Manyetik Kapı Contası
- * Dış Ortam Sıcaklığı + 30 °C & % 50 Nem
- * Sessiz Çalışma

Info

- * Inside Depth: 46,5 Cm
- * 35-40 Kg/m³ Ecology Friendly HCFC Free Polyurethane Insulation
- * Digital Touch Control Panel
- * Ambient LED Lighting
- * Door Lock
- * Automatic Water Evaporation System (Hot Gas System)
- * Special Wood and Railes Shelf System
- * Special Door and Hinge Systems
- * Removable and Easy Cleaning Magnetic Gasket
- * Ambient Temperature + 30 °C & % 50 Humidity
- * Minimum Noise while working

Kod Özellikleri



Available Codes

Raf ve Raf Kızağı
Shelf and Shelf Holder
49 €

L Sol Kapı (Dikey)
Left Door (Upright)
30 €

60hz 220 V
60 hz
56 €

WN4/2

Model Models	İç Sıcaklık Temperature °C	Şişe Kapasitesi Bottle Capacity	Ölçüler Dimensions Cm.	Paket Ölçüsü Packing Dim. Cm.	Ağırlık Weight Kg.	Paslanmaz Özellikli Stainless Steel Type
 WN4/2	+1/+10 +10/+20	72	60x66x182	70x76x192	150	430
 WN4	+1/+20	78	60x66x182	70x76x192	140	430
 WN1	+1/+20	30	60x66x90,5	70x76x100,5	145	430

İzolasyon Kalınlığı Insulation Thickness	Raf Adedi Shelf Unit	Soğutma Gazı Cooling Gas	Voltaj Voltage	Kapı Adedi Door Unit	Fiyat Price €	Model Models	Fiyat Price
50 mm	8	R134A	220 V / 50 Hz	1	4.935 €	WN4/2-R290	4.909 €
50 mm	8	R134A	220 V / 50 Hz	1	3.596 €	WN4-R290	3.570 €
50 mm	3	R290	220 V / 50 Hz	1	2.400 €	WN1-R290	2.373 €

Şarap Buzdolapları Wine Cabinets



50 Db

Sessiz Çalışma Özelliği
Silent Operation Feature

318 €

Option : 189 €

Özel İki Dereceli Bölüm
Special Two Temperature Zone

115 V / 60 Hz

8 Adet Kayar Ahşap Raf.
11 cm Aralıklı.
8 Unit Wood Sliding Shelf
11 cm Spaced.

Her Raf 6 Şişe Alır.
Each Shelf Contains
6 Glasses

Ölçü Detayları
Dimension Details



Dry Age & Wine Refrigerators

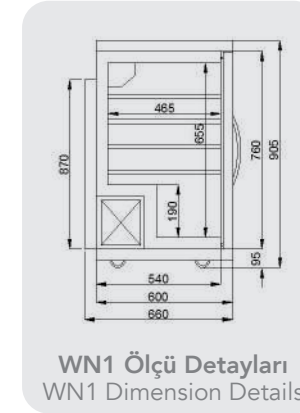

WN1 Ölçü Detayları
WN1 Dimension Details

WN1-SYS



WN4-SYS

Kod Özellikleri
Available Codes

Raf ve Raf Kızağı
Shelf and Shelf Holder 49 €

L Sol Kapı (Dikey)
Left Door (Upright) 30 €

60_{hz} 220 V
60 hz 56 €

Bilgi

- * İç Derinlik: 46,5 Cm
- * 35-40 Kg/m³ Çevre Dostu HCFC İçermeyen Poliüretan İzolasyon
- * Dijital Dokunmatik Kumanda Paneli
- * Ambianslı LED Aydınlatma
- * Kilitli Kapı
- * Otomatik Su Buharlaştırma Sistemi (Sıcak Gaz System)
- * Şarap Saklama İçin Özel Ahşap Raylı Raf
- * Özel Kapı ve Menteşe Sistemi
- * Temizlenebilir ve Sökülebilir Manyetik Kapı Contası
- * Dış Ortam Sıcaklığı + 30 °C & % 50 Nem
- * Sessiz Çalışma

Info

- * Inside Depth: 46,5 Cm
- * 35-40 Kg/m³ Ecology Friendly HCFC Free Polyurethane Insulation
- * Digital Touch Control Panel
- * Ambient LED Lighting
- * Door Lock
- * Automatic Water Evaporation System (Hot Gas System)
- * Special Wood and Railes Shelf System
- * Special Door and Hinge Systems
- * Removable and Easy Cleaning Magnetic Gasket
- * Ambient Temperature + 30 °C & % 50 Humidity
- * Minimum Noise while working

WN4/2-SYS

Model Models	İç Sıcaklık Temperature °C	Şişe Kapasitesi Bottle Capacity	Ölçüler Dimensions Cm.	Paket Ölçüsü Packing Dim. Cm.	Ağırlık Weight Kg.	Paslanmaz Özelligi Stainless Steel Type
WN4/2-SYS	+1/+10 +10/+20	72	60x66x182	70x76x192	150	Outside: Black Inside : Black
WN4-SYS	+1/+20	78	60x66x182	70x76x192	140	Outside: Black Inside : Black
WN1-SYS	+1/+20	30	60x66x90,5	70x76x100,5	145	Outside: Black Inside : Black

İzolasyon Kalınlığı Insulation Thickness	Raf Adedi Shelf Unit	Soğutma Gazı Cooling Gas	Voltaj Voltage	Kapı Adedi Door Unit	Fiyat Price €	Model Models	Fiyat Price
50 mm	8	R134A	220 V / 50 Hz	1	5.068 €	WN4-SYS-R290	5.041 €
50 mm	8	R134A	220 V / 50 Hz	1	3.729 €	WN4-SYS-R290	3.703 €
50 mm	3	R290	220 V / 50 Hz	1	2.529 €	WN4-SYS-R290	2.506 €

Şarap Buzdolapları Çift Taraflı Kapı

Wine Cabinets Double Sided Doors



FRENOX
PROFESSIONAL REFRIGERATION

Dry Age & Wine Refrigerators

Şişe Dizilimi / Bottle Placement



WN10-2-SB

WN10-2-BH

WN10-2-VB

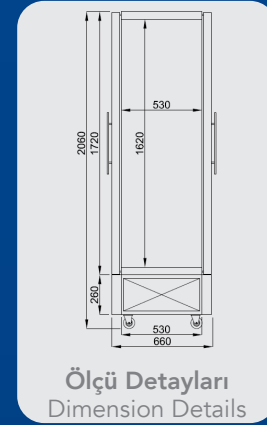

Ölçü Detayları
Dimension Details

Option : 189 €



115 V / 60 Hz

Bilgi

- * İç Derinlik: 53 Cm
- * Dijital Kontrol Paneli
- * Otomatik Su Buharlaştırma Sistemi
- * Led Lamba
- * Şarap Sergileme İçin Özel Tasarım
- * Özel Kapı ve Mentеше Sistemi
- * Temizlenebilir ve Sökülebilir Manyetik Kapı Contası
- * Dış Ortam Sıcaklığı + 30 °C & % 40 Nem
- * Sessiz Çalışma

Info

- * Inside Depth: 53 Cm
- * Digital Control Panel
- * LED Light
- * Automatic Water Evaporation System
- * Special Door and Hinge Systems
- * Special Design For The Wine Display
- * Removable and Easy Cleaning Magnetic Gasket
- * Ambient Temperature + 30 °C & % 40 Humidity
- * Minimum Noise while working

Kod Özellikleri

Available Codes

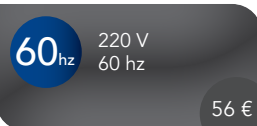
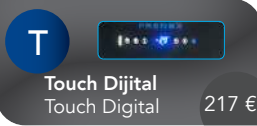
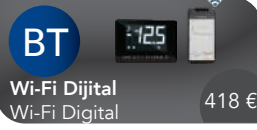



Özel Ölçü Opsiyonu

Custom Sizes Options

Işık Ayarlama Özelliği
Lighting Adjustment Feature



WN10-2-VB

Model Models	İç Sıcaklık Temperature °C	Şişe Kapasitesi Bottle Capacity	Ölçüler Dimensions Cm.	Paket Ölçüsü Packing Dim. Cm.	Ağırlık Weight Kg.	Paslanmaz Özellikler Stainless Steel Type
 WN10-2-BH	+5/+20	104	100x66x206	106x72x223	195	Cam / Glass
 WN10-2-VB	+5/+20	112	100x66x206	106x72x223	195	Cam / Glass
 WN10-2-SB	+5/+20	128	100x66x206	106x72x223	195	Cam / Glass

İzolasyon Kalınlığı Insulation Thickness	Raf Adedi Shelf Unit	Soğutma Gazı Cooling Gas	Voltaaj Voltage	Kapı Adedi Door Unit	Fiyat Price €	Model Models	Fiyat Price
4 Side Heated Glass	-	R134A	220 V / 50 Hz	4	7.844 €	WN10-2-BH-R290	7.818 €
4 Side Heated Glass	-	R134A	220 V / 50 Hz	4	8.548 €	WN10-2-VB-R290	8.522 €
4 Side Heated Glass	4	R134A	220 V / 50 Hz	4	6.435 €	WN10-2-SB-R290	6.409 €

Şarap Buzdolapları Arkası Camlı

Wine Cabinets Back Side Glass

Özel Ölçü Opsiyonu

Custom Sizes Options

Işık Ayarlama Özelliği
Lighting Adjustment Feature

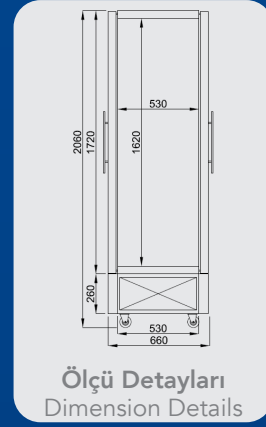
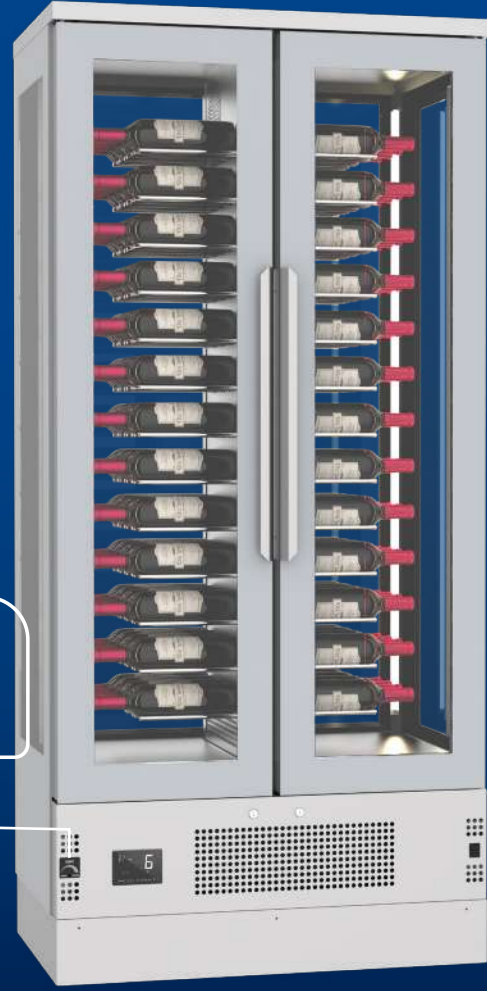

Ölçü Detayları
Dimension Details

Option : 189 €



WN10-BH



FRENOX
PROFESSIONAL REFRIGERATION

Dry Age & Wine Refrigerators

Şişe Dizilimi / Bottle Placement



WN10-SB



WN10-BH

Ø90 mm
H:380 mm

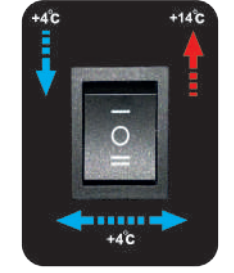

Bilgi

- * İç Derinlik: 53 Cm
- * Dijital Kontrol Paneli
- * Otomatik Su Buharlaştırma Sistemi
- * Led Lamba
- * Şarap Sergileme İçin Özel Tasarım
- * Özel Kapı ve Mentеше Sistemi
- * Temizlenebilir ve Sökülebilir Manyetik Kapı Contası
- * Dış Ortam Sıcaklığı + 30 °C & % 40 Nem
- * Sessiz Çalışma



Info

- * Inside Depth: 53 Cm
- * Digital Control Panel
- * LED Light
- * Automatic Water Evaporation System
- * Special Door and Hinge Systems
- * Special Design For The Wine Display
- * Removable and Easy Cleaning Magnetic Gasket
- * Ambient Temperature + 30 °C & % 40 Humidity
- * Minimum Noise while working

Kod Özellikleri

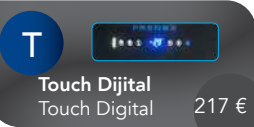
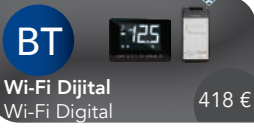
Available Codes



Model Models	İç Sıcaklık Temperature °C	Şişe Kapasitesi Bottle Capacity Lt.	Ölçüler Dimensions Cm.	Paket Ölçüsü Packing Dim. Cm.	Ağırlık Weight Kg.	Paslanmaz Özellikli Stainless Steel Type
 WN10-BH	+5/+20	104	100x62x206	106x68x223	190	Cam / Glass
 WN10-SB	+5/+20	128	100x62x206	106x68x223	190	Cam / Glass

İzolasyon Kalınlığı Insulation Thickness	Raf Adedi Shelf Unit	Soğutma Gazı Cooling Gas	Voltaj Voltage	Kapı Adedi Door Unit	Fiyat Price €	Model Models	Fiyat Price
4 Side Heated Glass	-	R134A	220 V / 50 Hz	2	7.140 €	WN10-BH-R290	7.113 €
4 Side Heated Glass	4	R134A	220 V / 50 Hz	2	5.731 €	WN10-SB-R290	5.705 €

Şarap Buzdolapları Arkası Camlı

Wine Cabinets Back Side Glass

Özel Ölçü Opsiyonu

Custom Sizes Options

Işık Ayarlama Özelliği
Lighting Adjustment Feature

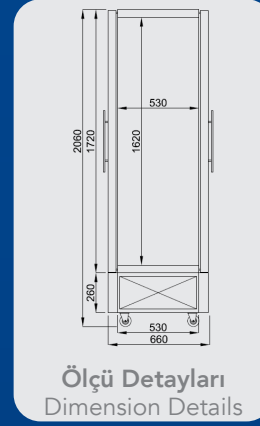

Ölçü Detayları
Dimension Details

Option : 189 €

115 V / 60 Hz

WN10-SB-SY



FRENOX
PROFESSIONAL REFRIGERATION

Dry Age & Wine Refrigerators

Şişe Dizilimi / Bottle Placement



WN10-SB-SY



WN10-BH-SY

Ø90 mm
H:380 mm

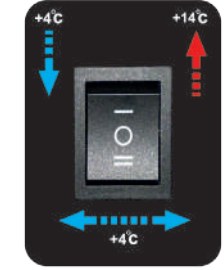

Bilgi

- * İç Derinlik: 53 Cm
- * Dijital Kontrol Paneli
- * Otomatik Su Buharlaştırma Sistemi
- * Led Lamba
- * Şarap Sergileme İçin Özel Tasarım
- * Özel Kapı ve Mentеше Sistemi
- * Temizlenebilir ve Sökülebilir Manyetik Kapı Contası
- * Dış Ortam Sıcaklığı + 30 °C & % 40 Nem
- * Sessiz Çalışma

Info

- * Inside Depth: 53 Cm
- * Digital Control Panel
- * LED Light
- * Automatic Water Evaporation System
- * Special Door and Hinge Systems
- * Special Design For The Wine Display
- * Removable and Easy Cleaning Magnetic Gasket
- * Ambient Temperature + 30 °C & % 40 Humidity
- * Minimum Noise while working

Kod Özellikleri

Available Codes

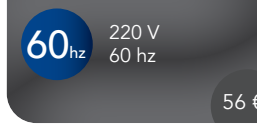

Model Models	İç Sıcaklık Temperature °C	Şişe Kapasitesi Bottle Capacity Lt.	Ölçüler Dimensions Cm.	Paket Ölçüsü Packing Dim. Cm.	Ağırlık Weight Kg.	Paslanmaz Özellikler Stainless Steel Type
 WN10-BH-SY	+5/+20	104	100x62x206	106x68x223	190	Cam / Glass
 WN10-SB-SY	+5/+20	128	100x62x206	106x68x223	190	Cam / Glass

İzolasyon Kalınlığı Insulation Thickness	Raf Adedi Shelf Unit	Soğutma Gazı Cooling Gas	Voltaj Voltage	Kapı Adedi Door Unit	Fiyat Price €	Model Models	Fiyat Price
4 Side Heated Glass	-	R134A	220 V / 50 Hz	2	7.421 €	WN10-SY-BH-R290	7.395 €
4 Side Heated Glass	4	R134A	220 V / 50 Hz	2	6.013 €	WN10-SY-SB-R290	5.987 €

Özel Ölçüde Dry Age & Şarap Buzdolabı

Custom Size Dry Age & Wine Cabinets



FRENOX
PROFESSIONAL REFRIGERATION

Dry Age & Wine Refrigerators



SPD11

Option : 189 €

115 V / 60 Hz

Özel Ölçü Opsiyonu

Custom Sizes Options

1.512 €

Farklı Renk Seçenekleri
Different Color Options



SPD11

Farklı Logo Seçenekleri
Different Logo Options

467 €

Bilgi

- * Projeye Göre Müşterinin İsteddiği Ölçülerde
- * Aydınlatmalı LED Lamba
- * Kilitli Kapı
- * Şarap Saklama İçin Özel Raf
- * Özel Kapı ve Menteşe Sistemi
- * Temizlenebilir ve Sökülebilir Manyetik Kapı Contası
- * Dış Ortam Sıcaklığı + 30 °C & % 50 Nem
- * Sessiz Çalışma
- * Hem Et Hem Şarap İçin Üretilen Özel Teknoloji

Info



- * Custom Sizes Regarding to Customers Project
- * LED Light
- * Door Lock
- * Special Railes Shelf System
- * Special Door and Hinge Systems
- * Removable and Easy Cleaning Magnetic Gasket
- * Ambient Temperature + 30 °C & % 50 Humidity
- * Minimum Noise while working
- * Specific Technology for Meat and Wine

Kod Özellikleri

Available Codes

BT
Wi-Fi Dijital
Wi-Fi Digital
418 €

60_{hz}
220 V
60 hz
56 €

Model Models	İç Sıcaklık Temperature °C	Brüt Hacim Gross volume Lt.	Ölçüler Dimensions Cm.	Paslanmaz Özelliği Stainless Steel Type
 SPD11	+4/+10 +10/+20 +0/+5 %70 RH	1100	210X85X230 Projenize Uygun According to Your Project	Cam / Glass
 SPD11-A	+0/+5 %70 RH	Custom	105X85X230 Projenize Uygun According to Your Project	Cam / Glass
 SPD11-B	+1/+10 +10/+20	Custom	105X85X230 Projenize Uygun According to Your Project	Cam / Glass

İzolasyon Kalınlığı Insulation Thickness	Raf Adedi Shelf Unit	Soğutma Gazı Cooling Gas	Voltaj Voltage	Kapı Adedi Door Unit	Fiyat Price €
Double Glaze Heated Glass	Custom	R290	220 V / 50 Hz	4	21.311 €
Double Glaze Heated Glass	Custom	R290	220 V / 50 Hz	2	13.789 €
Double Glaze Heated Glass	Custom	R290	220 V / 50 Hz	2	9.402 €

Özel Ölçüde Camlı Şarap Buzdolabı

Custom Size Glass Wine Cabinets



Ability to monitor alarms online via internet
İnternet üzerinden online alarmları izleme
Ability to control all parameters online
Tüm parametreleri kontrol etme kabiliyeti



**Özel Ölçü
Opsiyonu**
Custom
Sizes
Options

**Farklı Ahşap
Kaplama Seçenekleri**
Different Wooden
Cover Options

3.024 €

SPD6-SY



SPD6-SY



SPD6-SY



SPD6 (Ahşap Kaplama)
(Wooden Cover)



SPD6 (Ahşap Kaplama)
(Wooden Cover)

Bilgi

- * Projeye Göre Müşterinin İsteddiği Ölçülerde
- * Aydınlatmalı LED Lamba
- * Kilitli Kapı
- * Şarap Saklama İçin Özel Raf
- * Özel Kapı ve Menteşe Sistemi
- * Temizlenebilir ve Sökülebilir Manyetik Kapı Contası
- * Dış Ortam Sıcaklığı + 30 °C & % 50 Nem
- * Sessiz Çalışma
- * Şarap İçin Üretilen Özel Teknoloji

Info

- * Custom Sizes Regarding to Customers Project
- * LED Light
- * Door Lock
- * Special Railes Shelf System
- * Special Door and Hinge Systems
- * Removable and Easy Cleaning Magnetic Gasket
- * Ambient Temperature + 30 °C & % 50 Humidity
- * Minimum Noise while working
- * Specific Technology for Wine

Model Models	İç Sıcaklık Temperature °C	Brüt Hacim Gross volume Lt.	Ölçüler Dimensions Cm.	Paslanmaz Özelliği Stainless Steel Type
 SPD6-SY	+1/+10 +10/+20 (Remote)	600	120X60X230 Projenize Uygun According to Your Project	Cam / Glass

İzolasyon Insulation	Raf Adedi Shelf Unit	Soğutma Gazı Cooling Gas	Voltaj Voltage	Kapı Adedi Door Unit	Fiyat Price €	Soğutma Grubu Model Cooling Unit/Model	Fiyat Price
Cam Kaplama Glass Cover	Custom	R404A	220 V / 50 Hz	4	13.261 €	 SPN1520 1HP (+4/+20)	3.752 €

Özel Ölçüde Camlı Şarap Buzdolabı

Custom Size Glass Wine Cabinets



SPD11-100-VB

Ability to monitor alarms online via internet
İnternet üzerinden online alarmları izleme
Ability to control all parameters online
Tüm parametreleri kontrol etme kabiliyeti



Özel Ölçü Opsiyonu
Custom Sizes Options

Farklı Renk Seçenekleri
Different Color Options

1.910 €



SPD11-SY-100-SB



SPD11-100-VB

Bilgi

- * Projeye Göre Müşterinin İstediği Ölçülerde
- * Aydınlatmalı LED Lamba
- * Kilitli Kapı
- * Şarap Saklama İçin Özel Raf
- * Özel Kapı ve Mentеше Sistemi
- * Temizlenebilir ve Sökülebilir Manyetik Kapı Contası
- * Dış Ortam Sıcaklığı + 30 °C & % 50 Nem
- * Sessiz Çalışma
- * Şarap İçin Üretilen Özel Teknoloji

Info

- * Custom Sizes Regarding to Customers Project
- * LED Light
- * Door Lock
- * Special Railes Shelf System
- * Special Door and Hinge Systems
- * Removable and Easy Cleaning Magnetic Gasket
- * Ambient Temperature + 30 °C & % 50 Humidity
- * Minimum Noise while working
- * Specific Technology for Wine

Model Models	İç Sıcaklık Temperature °C	Şişe Kapasitesi Lt	Ölçüler Dimensions Cm.	Paslanmaz Özelliği Stainless Steel Type
 SPD11-100-VB	+1/+20	120	100X71X225	Cam/Glass
 SPD11-100-SB	+1/+20	240	100X71X225	Cam/Glass
 SPD11-SY-100-VB	+1/+20	120	100X71X225	Cam/Glass
 SPD11-SY-100-SB	+1/+20	240	100X71X225	Cam/Glass

İzolasyon Kalınlığı Insulation Thickness	Raf Adeti Shelf Unit	Soğutma Gazı Cooling Gas	Voltaj Voltage	Kapı Adeti Door Unit	Fiyat Price €
50mm Isıtmalı Cam Heated Glass	10	R290	230V/1+N/50Hz	2	14.853 €
50mm Isıtmalı Cam Heated Glass	4	R290	230V/1+N/50Hz	2	13.261 €
50mm Isıtmalı Cam Heated Glass	10	R290	230V/1+N/50Hz	2	15.383 €
50mm Isıtmalı Cam Heated Glass	4	R290	230V/1+N/50Hz	2	13.792 €

Özel Ölçüde Şarap Buzdolabı

Custom Size Wine Cabinets



SPD11-240

Ability to monitor alarms online via internet
İnternet üzerinden online alarmları izleme

Ability to control all parameters online
Tüm parametreleri kontrol etme kabiliyeti

Özel Ölçü Opsiyonu
Custom Sizes Options

1.512 €

Farklı Renk Seçenekleri
Different Color Options



FRENOX
PROFESSIONAL REFRIGERATION

Dry Age & Wine Refrigerators



SPD11-240





SPD11-240-SS

Bilgi

- * Projeye Göre Müşterinin İsteddiği Ölçülerde
- * Aydınlatmalı LED Lamba
- * Kilitli Kapı
- * Şarap Saklama İçin Özel Raf
- * Özel Kapı ve Mentеше Sistemi
- * Temizlenebilir ve Sökülebilir Manyetik Kapı Contası
- * Dış Ortam Sıcaklığı + 30 °C & % 50 Nem
- * Sessiz Çalışma
- * Şarap İçin Üretilen Özel Teknoloji

Info

- * Custom Sizes Regarding to Customers Project
- * LED Light
- * Door Lock
- * Special Railes Shelf System
- * Special Door and Hinge Systems
- * Removable and Easy Cleaning Magnetic Gasket
- * Ambient Temperature + 30 °C & % 50 Humidity
- * Minimum Noise while working
- * Specific Technology for Wine

Model Models	İç Sıcaklık Temperature °C	Brüt Hacim Gross volume Lt.	Ölçüler Dimensions Cm.	Paslanmaz Özelliği Stainless Steel Type
 SPD11-240	0 / +5 +5 / +12 +12 / +20	1000 (Custom)	240x70x220 Projenize Uygun According to Your Project	Cam & 304
 SPD11-240-SS	+4/+10 +10/+20	1000 (Custom)	240x70x220 Projenize Uygun According to Your Project	Cam ve Altın Boyalı Kaplama Glass and Gold Painted Cover

İzolasyon Kalınlığı Insulation Thickness	Raf Adedi Shelf Unit	Soğutma Gazı Cooling Gas	Voltaj Voltage	Kapı Adedi Door Unit	Fiyat Price €
4 cm	Custom	R290	220 V / 50 Hz	3	20.003 €
4 cm	Custom	R290	220 V / 50 Hz	3	20.003 €

Özel Ölçüde Dry-Age Buzdolabı

Custom Size Dry-Age



FRENOX
PROFESSIONAL REFRIGERATION

Dry Age & Wine Refrigerators



Ability to monitor alarms online via internet
İnternet üzerinden online alarmları izleme
Ability to control all parameters online
Tüm parametreleri kontrol etme kabiliyeti

Özel Ölçü Opsiyonu

Custom Sizes Options

0 / +5
%65 RH

1.512 €

Farklı Renk Seçenekleri
Different Color Options

SPD11-217



SPD11-217 Arka (Back)

Bilgi

- * Projeye Göre Müşterinin İsteddiği Ölçülerde
- * Aydınlatmalı LED Lamba
- * Kilitli Kapı
- * Şarap Saklama İçin Özel Raf
- * Özel Kapı ve Menteşe Sistemi
- * Temizlenebilir ve Sökülebilir Manyetik Kapı Contası
- * Dış Ortam Sıcaklığı + 30 °C & % 50 Nem
- * Sessiz Çalışma
- * Özel Tuzlu Ürün

Info

- * Custom Sizes Regarding to Customers Project
- * LED Light
- * Door Lock
- * Special Railes Shelf System
- * Special Door and Hinge Systems
- * Removable and Easy Cleaning Magnetic Gasket
- * Ambient Temperature + 30 °C & % 50 Humidity
- * Minimum Noise while working
- * With Special Salt

Model Models	İç Sıcaklık Temperature °C	Brüt Hacim Gross volume Lt.	Ölçüler Dimensions Cm.	Paslanmaz Özelliği Stainless Steel Type
 SPD11-217	0 / +5 %75 RH	1350 (Custom)	217x80x220 Projenize Uygun According to Your Project	İçi: 316 SS Dışı: Siyah Boyalı Paslanmaz Inside: 316 SS Outside: Black Painted SS

İzolasyon Insulation	Raf Adedi Shelf Unit	Soğutma Gazı Cooling Gas	Voltaj Voltage	Kapı Adedi Door Unit	Fiyat Price €
4 cm	Custom	R290	220 V / 50 Hz	4	23.874 €

Özel Ölçüde Şarap Buzdolabı

Custom Size Wine Cabinets



FRENOX
PROFESSIONAL REFRIGERATION

Dry Age & Wine Refrigerators



Özel Şişe Vitrini
Special Glass Display



4 Ayrı Derece
4 Different Temperature

Özel Ölçü Opsiyonu
Custom Sizes Options

1.512 €

Farklı Renk Seçenekleri
Different Color Options

SPD11-330

Bilgi

- * Projeye Göre Müşterinin İsteddiği Ölçülerde
- * LED Aydınlatma
- * Kilitli Kapı
- * Şarap Saklama İçin Özel Raf
- * Özel Kapı ve Menteşe Sistemi
- * Temizlenebilir ve Sökülebilir Manyetik Kapı Contası
- * Dış Ortam Sıcaklığı + 30 °C & % 50 Nem
- * Sessiz Çalışma
- * Şarap İçin Üretilen Özel Teknoloji

Info

- * Custom Sizes Regarding to Customers Project
- * LED Light
- * Door Lock
- * Special Railes Shelf System
- * Special Door and Hinge Systems
- * Removable and Easy Cleaning Magnetic Gasket
- * Ambient Temperature + 30 °C & % 50 Humidity
- * Minimum Noise while working
- * Specific Technology for Wine

Model Models	İç Sıcaklık Temperature °C	Brüt Hacim Gross volume Lt.	Ölçüler Dimensions Cm.	Paslanmaz Özelliği Stainless Steel Type
 SPD11-330	0 / +5 +5 / +10 +10 / +15 +15 / +20	1500 (Custom)	330x70x220 Projenize Uygun According to Your Project	Cam & 304 Glass & 304

İzolasyon Insulation	Raf Adedi Shelf Unit	Soğutma Gazı Cooling Gas	Voltaj Voltage	Kapı Adedi Door Unit	Fiyat Price €	Soğutma Grubu Model Cooling Unit Model	Fiyat Price
4 cm	Custom	R404A	220 V / 50 Hz	4	22.197 €	 SPN1520 1HP (+4/+20)	3.752 €

Dry Age Buzdolapları

Dry Age Refrigerators



DR13-G

Option : 189 €

115 V / 60 Hz

41 Adet Raf Kapasitesi.
2,5 cm Aralıklı.
41 Unit Shelf Holder Capacity
2,5 cm Spaced

Nem Kontrolü
Humidity Control

304 SS Raf
304 SS Shelves

Özel Rezistanslı
Isı Cam

Special Heated
Glass



FRENOX
PROFESSIONAL REFRIGERATION

Dry Age & Wine Refrigerators

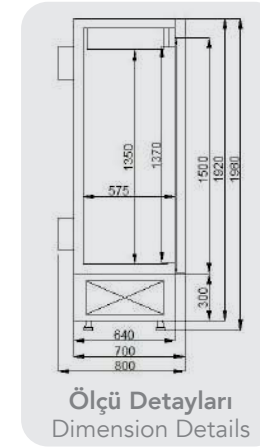

DR250-G

Kod Özellikleri
Available Codes

304 Paslanmaz Raf
304 Stainless Steel

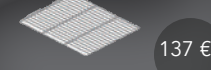

BT
Wi-Fi Dijital
Wi-Fi Digital

418 €

60^{hz}
220 V
60 hz

56 €

Bilgi

- * 35-40 Kg/m³ Çevre Dostu HCFC İçermeyen poliüretan İzolasyon
- * Özel Kumanda Sistemi – İç nem ve Sıcaklık Ayarı
- * Otomatik Su Buharlaştırma Sistemi (Sıcak Gaz)
- * Otomatik Defrost System
- * LED Aydınlatma
- * Temizlenebilir ve Sökülebilir Özel Conta Sistemi
- * Dış Ortam Sıcaklığı : + 32 C° & % 40 Nem
- * Özel Rezistanslı Isı Cam

Info

- * 35-40 Kg/m³ Ecology Friendly HCFC Free Polyurethane Insulation
- * Special Control System for Inside Humidity and Temperatur Setting.
- * Automatic Water Evaporation System (Hot Gas)
- * Automatic Defrost System
- * LED lighting
- * Removable and Easy Cleaning Magnetic Gaskets
- * Ambient Temperature. +32 C° & % 40 Humidity.
- * Special Heated Glass

Model Models	İç Sıcaklık Temperature °C	Nem Humidity	Brüt Hacim Gross volume Lt.	Ölçüler Dimensions Cm.	Paket Ölçüsü Packing Dim. Cm.	Ağırlık Weight Kg.	Paslanmaz Özelligi Stainless Steel Type
 DR13-G	0/+5	%65-%85 RH	1300	140x80x198	150x90x220	289	304
 DR6-G	0/+5	%65-%85 RH	600	70x80x198	85x85x220	179	304
 DR250-G	0/+5	%65-%85 RH	198	92x55x91	102x65x105	110	304

İzolasyon Kalınlığı Insulation Thickness	Raf Adedi Shelf Unit	Soğutma Gazı Cooling Gas	Voltaj Voltage	Kapı Adedi Door Unit	Fiyat Price €
60 mm	5	R404A	220 V / 50 Hz	2	9.855 €
60 mm	5	R404A	220 V / 50 Hz	1	7.195 €
60 mm	2	R404A	220 V / 50 Hz	2	4.536 €

Model Models	Fiyat Price €
DR13-G-R290	9.828 €
DR6-G-R290	7.168 €
DR250-G-R290	4.508 €

Dry Age Buzdolapları Özel Tuzlu

Dry Age Refrigerators Special Salt



FRENOX
PROFESSIONAL REFRIGERATION



SY13-G-HM

**ÖZEL
TUZLU
SPECIAL
SALT**

Option : 189 €

115 V / 60 Hz

Nem Kontrolü
Humidity Control

304 SS Raf
304 SS Shelves

Özel Rezistanslı
Isı Cam

Et Askısı

Special Heated
Glass

Meat Bar

Touch Dijital standart üretiminde mevcut değildir.
Fiyat için yan sayfaya bakınız.

Touch Digital is not available in standart production.
Check the options for the price.

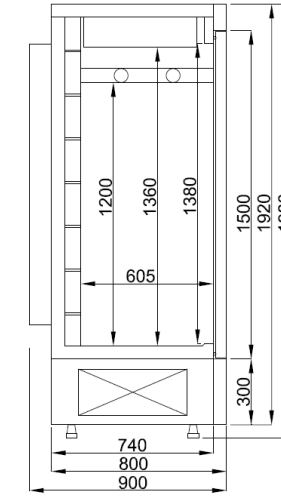

Dry Age & Wine Refrigerators

SY6-G-HM

Bilgi

- * 35-40 Kg/m³ Çevre Dostu HCFC İçermeyen Poliüretan İzolasyon
- * Özel Kumanda Sistemi – İç nem ve Sıcaklık Ayarı
- * Otomatik Su Buharlaştırma Sistemi (Sıcak Gaz)
- * Otomatik Defrost Sistemi
- * LED Aydınlatma
- * Temizlenebilir ve Sökülebilir Özel Conta Sistemi
- * Dış Ortam Sıcaklığı : + 32 C° & % 40 Nem
- * Özel Rezistanslı Isı Cam

Info

- * 35-40 Kg/m³ Ecology Friendly HCFC Free Polyurethane Insulation
- * Special Control System for Inside Humidity and Temperatur Setting.
- * Automatic Water Evaporation System (Hot Gas)
- * Automatic Defrost System
- * LED lighting
- * Removable and Easy Cleaning Magnetic Gaskets
- * Ambient Temperature. +32 C° & % 40 Humidity.
- * Special Heated Glass

Kod Özellikleri

Available Codes

316 Paslanmaz Raf
316 Stainless Steel

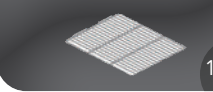



137 €

60hz 220 V
60 hz



56 €

Model Models	İç Sıcaklık Temperature °C	Nem Humidity	Brüt Hacim Gross volume Lt.	Ölçüler Dimensions Cm.	Paket Ölçüsü Packing Dim. Cm.	Ağırlık Weight Kg.	Paslanmaz Özelligi Stainless Steel Type
 SY13-G-HM	0/+5	%65-%85 RH	1300	140x90x198	150x100x220	289	316
 SY6-G-HM	0/+5	%65-%85 RH	600	70x90x198	80x100x220	179	316

İzolasyon Kalınlığı Insulation Thickness	Raf Adedi Shelf Unit	Soğutma Gazı Cooling Gas	Voltaj Voltage	Kapı Adedi Door Unit	Fiyat Price €	Model Models	Fiyat Price
60 mm	5	R404A	220 V / 50 Hz	2	11.924 €	SY13-G-HM-R290	11.897 €
60 mm	5	R404A	220 V / 50 Hz	1	10.447 €	SY6-G-HM-R290	10.419 €

Dry Age Buzdolapları

Dry Age Refrigerators

ARKA CAM
OPSİYONLU
OPTION BACK
GLASS



DR10-SY-G-HM

Nem Kontrolü
Humidity Control

304 SS Raf
304 SS Shelves

Özel Rezistanslı
Isı Cam

Special Heated
Glass

Et Askısı

Meat Bar

Özel
Ölçü
Opsiyonu

Custom
Sizes
Options

Option : 189 €

115 V / 60 Hz

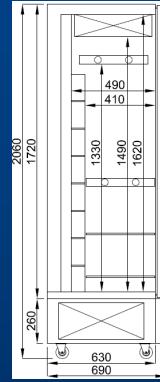

FRENOX
PROFESSIONAL REFRIGERATION

Dry Age & Wine Refrigerators



DR10-G



DR10-G

Bilgi

- * 35-40 Kg/m³ Çevre Dostu HCFC İçermeyen Poliüretan İzolasyon
- * Özel Kumanda Sistemi – İç nem ve Sıcaklık Ayarı
- * Otomatik Su Buharlaştırma Sistemi (Sıcak Gaz)
- * Otomatik Defrost Sistemi
- * LED Aydınlatma
- * Temizlenebilir ve Sökülebilir Özel Conta Sistemi
- * Dış Ortam Sıcaklığı : + 32 C° & % 40 Nem
- * Özel Rezistanslı Isı Cam

Info

- * 35-40 Kg/m³ Ecology Friendly HCFC Free Polyurethane Insulation
- * Special Control System for Inside Humidity and Temperatur Setting.
- * Automatic Water Evaporation System (Hot Gas)
- * Automatic Defrost System
- * LED lighting
- * Removable and Easy Cleaning Magnetic Gaskets
- * Ambient Temperature. +32 C° & % 40 Humidity.
- * Special Heated Glass

Kod Özellikleri
Available Codes

316 Paslanmaz Raf
316 Stainless Steel

137 €

WP

Su Geçirmez Dijital
Water Proof Digital

137 €

BT



Wi-Fi Dijital
Wi-Fi Digital

418 €

60hz

220 V
60 hz

56 €

Model Models	İç Sıcaklık Temperature °C	Nem Humidity	Brüt Hacim Gross volume Lt.	Ölçüler Dimensions Cm.	Paket Ölçüsü Packing Dim. Cm.	Ağırlık Weight Kg.	Paslanmaz Özellikçi Stainless Steel Type
 DR10-SY-G-HM	0/+5	%65-%85 RH	630	100x69x209	110x80x220	289	316
 DR10-G	0/+5	%65-%85 RH	680	100x69x209	110x80x220	179	316

İzolasyon Kalınlığı Insulation Thickness	Raf Adedi Shelf Unit	Soğutma Gazı Cooling Gas	Voltaj Voltage	Kapı Adedi Door Unit	Fiyat Price €	Model Models	Fiyat Price
60 mm	5	R404A	220 V / 50 Hz	2	13.874 €	DR10-G-HM-R290	13.847 €
60 mm	5	R404A	220 V / 50 Hz	2	13.149 €	DR10-G-R290	13.122 €

Dry Age Buzdolapları

Dry Age Refrigerators



DR4-SY

Option : 189 €

115 V / 60 Hz

Nem Kontrolü
Humidity Control

304 SS Raf
304 SS Shelves

Özel Rezistanslı
Isı Cam

Et Askısı

Special Heated
Glass

Meat Bar



Dry Age & Wine Refrigerators

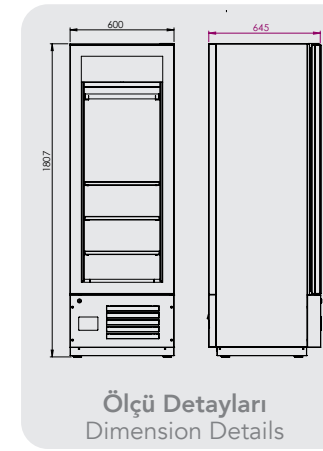

DR4-SY

Bilgi

- * 35-40 Kg/m³ Çevre Dostu HCFC İçermeyen Poliüretan İzolasyon
- * Özel Kumanda Sistemi – İç nem ve Sıcaklık Ayarı
- * Otomatik Su Buharlaştırma Sistemi (Sıcak Gaz)
- * Otomatik Defrost Sistemi
- * LED Aydınlatma
- * Temizlenebilir ve Sökülebilir Özel Conta Sistemi
- * Dış Ortam Sıcaklığı : + 32 C° & % 40 Nem
- * Özel Rezistanslı Isı Cam

Info

- * 35-40 Kg/m³ Ecology Friendly HCFC Free Polyurethane Insulation
- * Special Control System for Inside Humidity and Temperatur Setting.
- * Automatic Water Evaporation System (Hot Gas)
- * Automatic Defrost System
- * LED lighting
- * Removable and Easy Cleaning Magnetic Gaskets
- * Ambient Temperature. +32 C° & % 40 Humidity.
- * Special Heated Glass

Kod Özellikleri

Available Codes

316 Paslanmaz Raf
316 Stainless Steel
137 €

60 hz 220 V
60 hz
56 €

Model Models	İç Sıcaklık Temperature °C	Nem Humidity	Brüt Hacim Gross volume Lt.	Ölçüler Dimensions Cm.	Paket Ölçüsü Packing Dim. Cm.	Ağırlık Weight Kg.	Paslanmaz Özelliği Stainless Steel Type
 DR4-SY	0/+5	%65-%85 RH	600	65x60x180	70x65x190	128	316

İzolasyon Kalınlığı Insulation Thickness	Raf Adedi Shelf Unit	Soğutma Gazı Cooling Gas	Voltaj Voltage	Kapı Adedi Door Unit	Fiyat Price €	Model Models	Fiyat Price
60 mm	5	R290	220 V / 50 Hz	1	8.450 €	DR4-SY-R290	8.450 €

Dry Age Buzdolapları Özel Tuzlu

Dry Age Refrigerators Special Salt

ÖZEL
TUZLU
SPECIAL
SALT

Option : 189 €

115 V / 60 Hz



SY250-G-HM

Nem Kontrolü
Humidity Control

304 SS Raf
304 SS Shelves

Özel Rezistanslı
Isı Cam

Et Askısı

Special Heated
Glass

Meat Bar



FRENOX
PROFESSIONAL REFRIGERATION

Dry Age & Wine Refrigerators

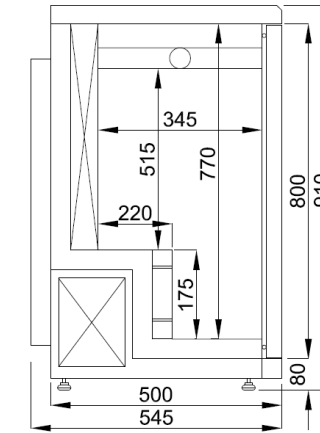

SY150-G-HM

Bilgi

- * 35-40 Kg/m³ Çevre Dostu HCFC İçermeyen Poliüretan İzolasyon
- * Özel Kumanda Sistemi – İç nem ve Sıcaklık Ayarı
- * Otomatik Su Buharlaştırma Sistemi (Sıcak Gaz)
- * Otomatik Defrost Sistemi
- * LED Aydınlatma
- * Temizlenebilir ve Sökülebilir Özel Conta Sistemi
- * Dış Ortam Sıcaklığı : + 32 C° & % 40 Nem
- * Özel Rezistanslı Isı Cam

Info

- * 35-40 Kg/m³ Ecology Friendly HCFC Free Polyurethane Insulation
- * Special Control System for Inside Humidity and Temperatur Setting.
- * Automatic Water Evaporation System (Hot Gas)
- * Automatic Defrost System
- * LED lighting
- * Removable and Easy Cleaning Magnetic Gaskets
- * Ambient Temperature. +32 C° & % 40 Humidity.
- * Special Heated Glass

Kod Özellikleri Available Codes

316 Paslanmaz Raf
316 Stainless Steel

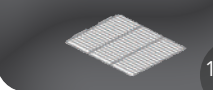



137 €

60hz 220 V
60 hz



56 €

Model Models	İç Sıcaklık Temperature °C	Nem Humidity	Brüt Hacim Gross volume Lt.	Ölçüler Dimensions Cm.	Paket Ölçüsü Packing Dim. Cm.	Ağırlık Weight Kg.	Paslanmaz Özelligi Stainless Steel Type
 SY250-G-HM	0/+5	%85	198	92x55x91	102x65x105	110	316
 SY150-G-HM	0/+5	%85	103	59,5x50x91	70x65x105	80	316

İzolasyon Kalınlığı Insulation Thickness	Raf Adedi Shelf Unit	Soğutma Gazı Cooling Gas	Voltaj Voltage	Kapı Adedi Door Unit	Fiyat Price €	Model Models	Fiyat Price
30	1	R404	220 V 50 HZ	1	5.900 €	SY250-G-HM-R290	5.873 €
30	1	R404		1	5.030 €	SY150-G-HM-R290	5.003 €



Çikolata / Pasta Vitrin Buzdolabı
Jewellery Showcase Refrigerator

212-213

222-223

Dik Vitrin Buzdolabı / Derin Dondurucu
Vertical Display Refrigerator / Freezer



214-215

Çikolata / Pasta Vitrin Buzdolabı
Jewellery Showcase Refrigerator



Dik Vitrin Buzdolabı / Derin Dondurucu
Vertical Display Refrigerator / Freezer

224-225



Vitrin Buzdolabı
Display Refrigerator

216-217

226-227

Yatay Buzdolapları - Önü Camlı
Counter Type Refrigerators - Front Glass



218-219

Önü Açık Vitrin Buzdolabı
Display Refrigerator with Open Front



Paslanmaz Metal Gövde Vitrin Buzdolabı
Stainless Steel Display Refrigerator

220-221

Çikolata / Pasta Vitrin Buzdolabı Jewellery Showcase Refrigerator

Özel
Ölçü
Opsiyonu

Custom Sizes
Options



Option : 189 €

115 V / 60 Hz



Farklı kaplama seçenekleri
Different cover options

JB130-T



FRENOX
PROFESSIONAL REFRIGERATION

Display Refrigerators

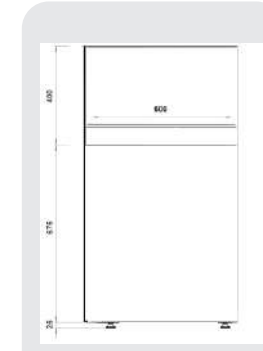

Ölçü Detayları
Dimension Details



JB130-T Back



JB90-T Back

Bilgi



- * Poliüretansız Yapı
- * Dijital Kumanda Paneli
- * Otomatik Su Buharlaştırma Sistemi
- * Otomatik Defrost
- * Özel Camlı Çekmece
- * Pasta ve Çikolataya Uygun
- * Dış Ortam Sıcaklığı + 30°C & % 40 Nem
- * Temizlik amaçlı kolay açılabilen sürgü kapılar
- * Güçlü Aydınlatma

Info

- * Free Polyurethane Insulation
- * Digital Control Panel
- * Automatic Water Evaporation System
- * Automatic Defrost
- * Special Glass Drawer
- * Designed for Chocolate & Cake
- * Ambient Temperature + 30°C & % 40 Nem
- * Removable and Easy Cleaning Sliding Door
- * Strong Lighting

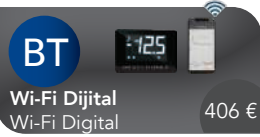
Kod Özellikleri Available Codes



Model Models	İç Sıcaklık Temperature °C	Büt Hacim Gross volume Lt.	Ölçüler Dimensions Cm.	Paket Ölçüsü Packing Dim. Cm.	Ağırlık Weight Kg.	Paslanmaz Özelliği Stainless Steel Type
 JB130-T	+4/+10	130	130x70x110	140x90x130	300	Cam Glass
 JB90-T	+4/+10	90	90x70x110	100x90x130	280	Cam Glass
 JB130-CK	+10/+16 LESS THAN %65 RH	130	130x70x110	140x90x130	300	Cam Glass
 JB90-CK	+10/+16 LESS THAN %65 RH	90	90x70x110	100x90x130	280	Cam Glass

Soğutma Şekli Cooling Type	Raf Adedi Shelf Unit	Soğutma Gazı Cooling Gas	Voltaj Voltage	Çekmece Adedi Drawer Unit	Fiyat Price €
Fanlı Ventilated	-	R290	220 V / 50 Hz	2	4.774 €
Fanlı Ventilated	-	R290	220 V / 50 Hz	1	4.031 €
Fanlı Ventilated	-	R290	220 V / 50 Hz	2	5.039 €
Fanlı Ventilated	-	R290	220 V / 50 Hz	1	4.244 €

Çikolata / Pasta Vitrin Buzdolabı

Jewellery Showcase Refrigerator

Özel Ölçü Opsiyonu

Custom Sizes Options

Option : 189 €

115 V / 60 Hz

DR

Drop-In Option
- %5

Farklı kaplama seçenekleri
Different cover options

JB130-SY-T



FRENOX
PROFESSIONAL REFRIGERATION

Display Refrigerators

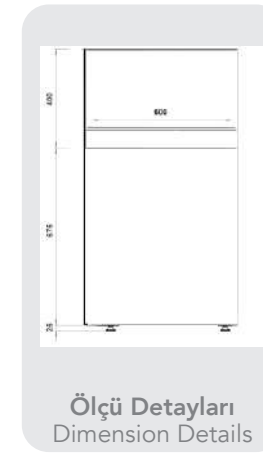

Ölçü Detayları
Dimension Details



JB130-SY-T Back



JB90-SY-T Back

Bilgi

- * Poliüretansız Yapı
- * Dijital Kumanda Paneli
- * Otomatik Su Buharlaştırma Sistemi
- * Otomatik Defrost
- * Özel Camlı Çekmece
- * Pasta ve Çikolataya Uygun
- * Dış Ortam Sıcaklığı + 30°C & % 40 Nem
- * Temizlik amaçlı kolay açılabilen sürgü kapılar
- * Güçlü Aydınlatma

Info

- * Free Polyurethane Insulation
- * Digital Control Panel
- * Automatic Water Evaporation System
- * Automatic Defrost
- * Special Glass Drawer
- * Designed for Chocolate & Cake
- * Ambient Temperature + 30°C & % 40 Nem
- * Removable and Easy Cleaning Sliding Door
- * Strong Lighting

Kod Özellikleri Available Codes

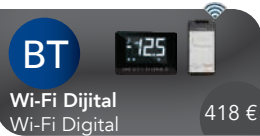

Model Models	İç Sıcaklık Temperature °C	Brüt Hacim Gross volume Lt.	Ölçüler Dimensions Cm.	Paket Ölçüsü Packing Dim. Cm.	Ağırlık Weight Kg.	Paslanmaz Özellikler Stainless Steel Type
 JB130-SY-T	+4/+10	130	130x70x110	140x90x130	300	Cam Glass
 JB90-SY-T	+4/+10	90	90x70x110	100x90x130	280	Cam Glass
 JB130-SY-CK	+10/+16 LESS THAN %65 RH	130	130x70x110	140x90x130	300	Cam Glass
 JB90-SY-CK	+10/+16 LESS THAN %65 RH	90	90x70x110	100x90x130	280	Cam Glass

Soğutma Şekli Cooling Type	Raf Adedi Shelf Unit	Soğutma Gazı Cooling Gas	Voltaj Voltage	Çekmece Adedi Drawer Unit	Fiyat Price €
Fanlı Ventilated	-	R290	220 V / 50 Hz	2	4.562 €
Fanlı Ventilated	-	R290	220 V / 50 Hz	1	3.819 €
Fanlı Ventilated	-	R290	220 V / 50 Hz	2	4.933 €
Fanlı Ventilated	-	R290	220 V / 50 Hz	1	4.138 €

Vitrin Buzdolabı

Display Refrigerator



VTN80-SY

Özel Ölçü Opsiyonu

Option : 189 €



Custom Sizes Options



Farklı kaplama seçenekleri
Different cover options

Ön ızgara yok.
No front grill



FRENOX
PROFESSIONAL REFRIGERATION

Display Refrigerators

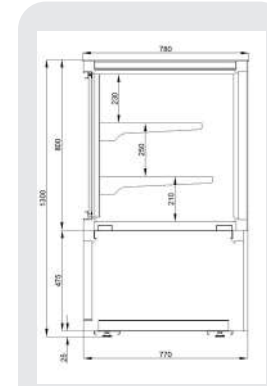

Ölçü Detayları
Dimension Details



VTN 200-SY

Sürgü Kapılar Otomatik Kapanmaz. / Sliding Glass Door Closed Manually.

Bilgi

- * 35-40 Kg/m³ Çevre Dostu HCFC İçermeyen Poliüretan İzolasyon
- * Dijital Kumanda Paneli
- * Kilitli Kapı
- * Otomatik Su Buharlaştırma Sistemi
- * Otomatik Defrost
- * Özel Sürgü Kapılı
- * Kapalı Ön Kanopü
- * Dış Ortam Sıcaklığı + 30°C & % 40 Nem
- * Temizlik amaçlı kolay açılabilen sürgü kapılar
- * Güçlü Aydınlatma

Info

- * 35-40 Kg/m³ Ecology Friendly HCFC Free Polyurethane Insulation
- * Digital Control Panel
- * Door Lock
- * Automatic Water Evaporation System
- * Automatic Defrost
- * Special Sliding Door
- * Closed Front Panel
- * Ambient Temperature + 30°C & % 40 Nem
- * Removable and Easy Cleaning Sliding Door
- * Strong Lighting

Kod Özellikleri

Available Codes

T Touch Dijital
Touch Digital 217 €

BT Wi-Fi Dijital
Wi-Fi Digital 418 €

60_{hz} 220 V
60 hz 56 €

WP Su Geçirmez Dijital
Water Proof Digital 137 €

Model Models	İç Sıcaklık Temperature °C	Brüt Hacim Gross volume Lt.	Ölçüler Dimensions Cm.	Paket Ölçüsü Packing Dim. Cm.	Ağırlık Weight Kg.	Paslanmaz Özelliği Stainless Steel Type
 VTN80-SY	+2/+10	300	80x78x130	100x98x150	100	Cam Glass
 VTN100-SY	+2/+10	375	100x78x130	120x98x150	105	Cam Glass
 VTN120-SY	+2/+10	450	120x78x130	140x98x150	110	Cam Glass
 VTN160-SY	+2/+10	600	160x78x130	180x98x150	115	Cam Glass
 VTN200-SY	+2/+10	750	200x78x130	220x98x150	120	Cam Glass

Soğutma Şekli Cooling Type	Raf Adedi Shelf Unit	Soğutma Gazı Cooling Gas	Voltaj Voltage	Kapı Adedi Door Unit	Fiyat Price €
Fanlı Ventilated	2	R290	220 V / 50 Hz	Sürgü Cam Sliding Glass	3.247 €
Fanlı Ventilated	2	R290	220 V / 50 Hz	Sürgü Cam Sliding Glass	3.689 €
Fanlı Ventilated	2	R290	220 V / 50 Hz	Sürgü Cam Sliding Glass	3.985 €
Fanlı Ventilated	2	R290	220 V / 50 Hz	Sürgü Cam Sliding Glass	5.702 €
Fanlı Ventilated	2	R290	220 V / 50 Hz	Sürgü Cam Sliding Glass	6.199 €

Önü Açık Vitrin Buzdolabı

Display Refrigerator with Open Front

Option : 189 €

115 V / 60 Hz

Özel Ölçü Opsiyonu

Custom Sizes Options



VTN190-OP-SY



FRENOX
PROFESSIONAL REFRIGERATION

Display Refrigerators

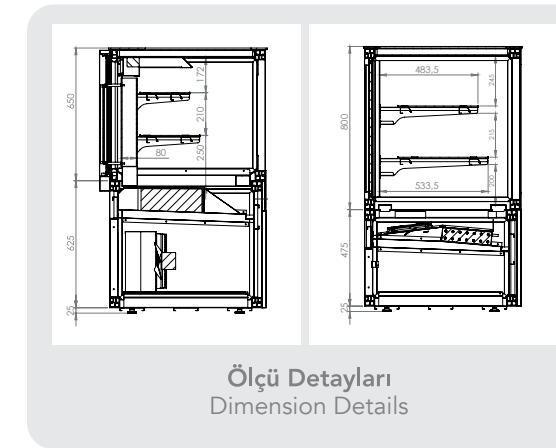

Ölçü Detayları
Dimension Details



VTN90-OP-SY

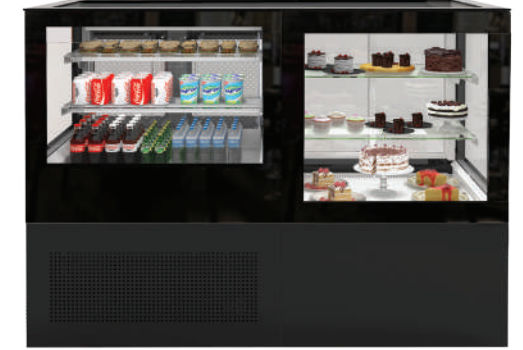

VTN170-OP-SY

Bilgi

- * 35-0 Kg/m³ Çevre Dostu HCFC İçermeyen Poliüretan İzolasyon
- * Dijital Kumanda Paneli
- * Açık Taraflı Gece Perdesi
- * Otomatik Su Buharlaştırma Sistemi
- * Otomatik Defrost
- * Özel Sürgü Kapılı
- * Kapalı Ön Kanopli
- * Dış Ortam Sıcaklığı + 30°C & % 40 Nem
- * Güçlü Aydınlatma

Info

- * 35-40 Kg/m³ Ecology Friendly HCFC Free Polyurethane Insulation
- * Digital Control Panel
- * Curtain in Open Side
- * Automatic Water Evaporation System
- * Automatic Defrost
- * Special Sliding Door
- * Closed Front Panel
- * Ambient Temperature + 30°C & % 40 Nem
- * Strong Lighting

Kod Özellikleri Available Codes

T
Touch Dijital
Touch Digital 217 €

BT
Wi-Fi Dijital
Wi-Fi Digital 418 €

60_{hz}
220 V
60 hz 56 €

WP
Su Geçirmez Dijital
Water Proof Digital 137 €

Model Models	İç Sıcaklık Temperature °C	Brüt Hacim Gross volume Lt.	Ölçüler Dimensions Cm.	Paket Ölçüsü Packing Dim. Cm.	Ağırlık Weight Kg.	Paslanmaz Özelligi Stainless Steel Type
 VTN90-OP-SY	+2/+10	300	90x78x130	120x100x150	100	Cam Glass
 VTN170-OP-SY	+2/+10	675	170x78x130	200x100x150	200	Cam Glass
 VTN190-OP-SY	+2/+10	700	190x78x130	220x100x150	220	Cam Glass

Soğutma Şekli Cooling Type	Raf Adedi Shelf Unit	Soğutma Gazı Cooling Gas	Voltaj Voltage	Kapı Adedi Door Unit	Fiyat Price €
Fanlı Ventilated	2	R452A	220 V / 50 Hz	2	4.774 €
Fanlı Ventilated	4	R452A R290	220 V / 50 Hz	4	7.957 €
Fanlı Ventilated	4	R452A R290	220 V / 50 Hz	4	8.487 €

Paslanmaz Metal Gövde Vitrin Buzdolabı

Stainless Steel Display Refrigerator

Option : 189 €

115 V / 60 Hz

Özel Ölçü Opsiyonu

Custom Sizes Options

Paslanmaz Metal Gövde
Stainless Steel

VTN90-G-SS



FRENOX
PROFESSIONAL REFRIGERATION

Display Refrigerators

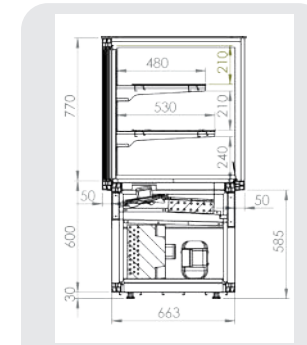

Ölçü Detayları
Dimension Details



VTN90-G-SS

Sürgü Kapılar Otomatik Kapanmaz. / Sliding Glass Door Closed Manually.

Bilgi

- * 35-40 Kg/m³ Çevre Dostu HCFC İçermeyen Poliüretan İzolasyon
- * Dijital Kumanda Paneli
- * Otomatik Su Buharlaştırma Sistemi
- * Otomatik Defrost
- * Özel Sürgü Kapılı
- * Kapalı Ön Kanopi
- * Dış Ortam Sıcaklığı + 30°C & % 40 Nem
- * Güçlü Aydınlatma
- * 430 SS

Info

- * 35-40 Kg/m³ Ecology Friendly HCFC Free Polyurethane Insulation
- * Digital Control Panel
- * Automatic Water Evaporation System
- * Automatic Defrost
- * Special Sliding Door
- * Closed Front Panel
- * Ambient Temperature + 30°C & % 40 Nem
- * Strong Lighting
- * 430 SS

Kod Özellikleri



Available Codes

T
Touch Dijital
Touch Digital 217 €

BT
Wi-Fi Dijital
Wi-Fi Digital 418 €

60_{hz}
220 V
60 hz 56 €

WP
Su Geçirmez Dijital
Water Proof Digital 137 €

Model Models	İç Sıcaklık Temperature °C	Brüt Hacim Gross volume Lt.	Ölçüler Dimensions Cm.	Paket Ölçüsü Packing Dim. Cm.	Ağırlık Weight Kg.	Paslanmaz Özelliği Stainless Steel Type
 VTN90-G-SS	+2/+15	300	90x78x140	120x100x160	100	Cam Glass
 VTN120-G-SS	+2/+15	400	120x78x140	140x100x160	120	Cam Glass
 VTN160-G-SS	+2/+15	540	130x78x140	151x100x160	220	Cam Glass

Soğutma Şekli Cooling Type	Raf Adedi Shelf Unit	Soğutma Gazı Cooling Gas	Voltaaj Voltage	Sürgü Kapı Sliding Door	Fiyat Price €
Fanlı Ventilated	2	R290	220 V / 50 Hz	2	3.713 €
Fanlı Ventilated	2	R290	220 V / 50 Hz	2	4.138 €
Fanlı Ventilated	2	R290	220 V / 50 Hz	2	5.570 €

Dik Vitrin Buzdolabı / Derin Dondurucu

Vertical Display Refrigerator / Freezer



Display Refrigerators



DN4

Option : 189 €

115 V / 60 Hz

Özel Ölçü Opsiyonu

Custom Sizes Options

5 Adet Raf Kapasiteli

5 Shelves Capacity

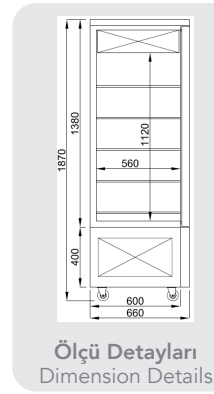

Ölçü Detayları
Dimension Details



DN4



DN4-CK



DL4

Bilgi

- * 35-40 Kg/m³ Çevre Dostu HCFC İçermeyen Poliüretan İzolasyon
- * Dijital Kumanda Paneli
- * Kilitli Kapı
- * Otomatik Su Buharlaştırma Sistemi
- * Otomatik Defrost
- * Özel Kapı ve Menteşe Sistemi
- * Temizlenebilir ve Sökülebilir Manyetik Kapı Contası
- * Dış Ortam Sıcaklığı + 30°C & % 40 Nem
- * Çikolata saklama için özel gösterge

Info

- * 35-40 Kg/m³ Ecology Friendly HCFC Free Polyurethane Insulation
- * Digital Control Panel
- * Door Lock
- * Automatic Water Evaporation System
- * Automatic Defrost
- * Special Door and Hinge Systems
- * Removable and Easy Cleaning Magnetic Gasket
- * Ambient Temperature + 30°C & % 40 Nem
- * Special Display for Chocolate Storage

Kod Özellikleri Available Codes

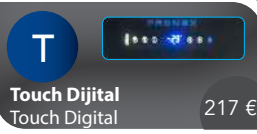



217 €



418 €



56 €

Model Models	İç Sıcaklık Temperature °C	Brüt Hacim Gross volume Lt.	Ölçüler Dimensions Cm.	Paket Ölçüsü Packing Dim. Cm.	Ağırlık Weight Kg.	Paslanmaz Özelligi Stainless Steel Type
 DN4	+2/+10	400	80x66x187	86x72x205	140	Cam Glass
 DL4	-15/-18	400	80x66x187	86x72x205	145	Cam Glass
 DN4-CK	+10/+14	400	80x66x187	86x72x205	140	Cam Glass

Soğutma Şekli Cooling Type	Raf Adedi Shelf Unit	Soğutma Gazı Cooling Gas	Voltaj Voltage	Kapı Adedi Door Unit	Fiyat Price €	Model Models	Fiyat Price
Fanlı Ventilated	5	R134A	220 V / 50 Hz	1	4.347 €	DN4-R290	4.320 €
Fanlı Ventilated	5	R404A	220 V / 50 Hz	1	6.078 €	DL4-R452A	6.051 €
Fanlı Ventilated	5	R134A	220 V / 50 Hz	1	4.749 €	DN4-CK-R290	4.723 €

Dik Vitrin Buzdolabı / Derin Dondurucu

Vertical Display Refrigerator / Freezer

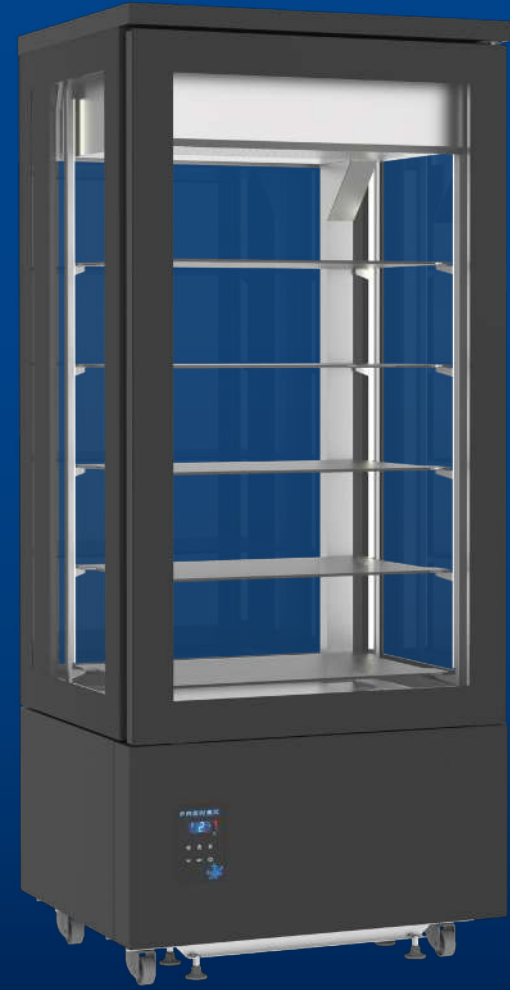

DN4-SY

Özel Ölçü Opsiyonu

Custom Sizes Options

Option : 189 €

115 V / 60 Hz

5 Adet Raf Kapasiteli

5 Shelves Capacity



Display Refrigerators

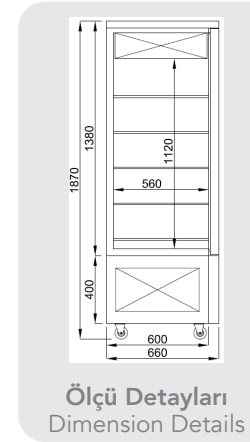

Ölçü Detayları
Dimension Details



DN4-SY



DL4-SY



DN4-CK-SY

Bilgi



- * 35-40 Kg/m³ Çevre Dostu HCFC İçermeyen Poliüretan İzolasyon
- * Dijital Kumanda Paneli
- * Kilitli Kapı
- * Otomatik Su Buharlaştırma Sistemi
- * Otomatik Defrost
- * Özel Kapı ve Menteşe Sistemi
- * Temizlenebilir ve Sökülebilir Manyetik Kapı Contası
- * Dış Ortam Sıcaklığı + 30°C & % 40 Nem
- * Çikolata saklama için özel gösterge

Info

- * 35-40 Kg/m³ Ecology Friendly HCFC Free Polyurethane Insulation
- * Digital Control Panel
- * Door Lock
- * Automatic Water Evaporation System
- * Automatic Defrost
- * Special Door and Hinge Systems
- * Removable and Easy Cleaning Magnetic Gasket
- * Ambient Temperature + 30°C & % 40 Nem
- * Special Display for Chocolate Storage

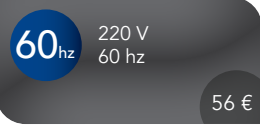
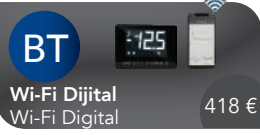
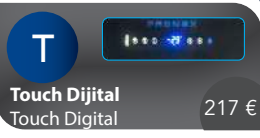
Kod Özellikleri Available Codes



Model Models	İç Sıcaklık Temperature °C	Brüt Hacim Gross volume Lt.	Ölçüler Dimensions Cm.	Paket Ölçüsü Packing Dim. Cm.	Ağırlık Weight Kg.	Paslanmaz Özelligi Stainless Steel Type
 DN4-SY	+2/+10	400	80x66x187	86x72x205	140	Cam Glass
 DL4-SY	-15/-25	400	80x66x187	86x72x205	145	Cam Glass
 DN4-CK-SY	+10/+14	400	80x66x187	86x72x205	140	Cam Glass

Soğutma Şekli Cooling Type	Raf Adedi Shelf Unit	Soğutma Gazı Cooling Gas	Voltaj Voltage	Kapı Adedi Door Unit	Fiyat Price €	Model Models	Fiyat Price
Fanlı Ventilated	5	R134A	220 V / 50 Hz	1	4.380 €	DN4-SY-R290	4.354 €
Fanlı Ventilated	5	R404A	220 V / 50 Hz	1	6.186 €	DL4-SY-R452A	6.159 €
Fanlı Ventilated	5	R134A	220 V / 50 Hz	1	4.837 €	DN4-SY-CK-R290	4.810 €

Yatay Buzdolapları - Önü Camlı

Counter Type Refrigerators - Front Glass



Option : 189 €

115 V / 60 Hz

KF
143€
Fanlı Kanopi
Canopy With Fan

CGN2-BG-DZ



Display Refrigerators

Kapı Seçenekleri / Door Options



G Cam Kapı - Glass Door 228 €

Bilgi

- * İç Derinlik: 43 Cm / 53 Cm (GN 1/1 Kapasiteli)
- * 35-40 Kg/m³ Çevre Dostu HCFC İçermeyen Poliüretan İzolasyon
- * Dijital Kumanda Paneli
- * Elektrik Rezistanslı Otomatik Defrost
- * Özel Su Buharlaştırma Sistemi
- * Yüksekliği Ayarlanabilir Paslanmaz Ayaklar
- * Özel, Kapı Mentеше Sistemi
- * Temizlenebilir ve Sökülebilir Manyetik Kapı Contası
- * Dış Ortam Sıcaklığı: + 43°C & % 65 Nem

Info

- * Inside Depth: 43 Cm / 53 Cm (GN 1/1 Capacity)
- * 35-40 Kg/m³ Ecology Friendly HCFC Free Polyurethane Insulation
- * Digital Control Panel
- * Electrical Resistor Automatic Defrost
- * Special Water Evaporation
- * Stainless Steel Legs Adjustable For Height
- * Special Door and Hinge Systems
- * Removable and Easy Cleaning Magnetic Gaskets
- * Ambient Temperature: + 43°C %65 Humidity

Kod Özellikleri

Available Codes

WP 137 €
Su Geçirmez Dijital
Water Proof Digital

Raf ve Raf Kızağı 49 €
Shelf and Shelf Holder

K 70 €/Unt
Kilitli Kapı
With Lock

A 70 €
10 cm Yuvarlatılmış
Sırtlı Tabla
10 cm Curved
Splashback Work Top

GR 2 Door 858 €
3 Door 1057 €
4 Door 1374 €
Granit Üst Tabla
Granite Work Top

MR 2 Door 418 €
3 Door 531 €
4 Door 727 €
Mermer Üst Tabla
Marble Work Top

PL 2 Door 780 €
3 Door 1014 €
4 Door 1316 €
Polietilen Üst Tabla
Polyethylene Work Top

F 2 Door 109 €
3 Door 139 €
4 Door 182 €
Üst Tablasız
Without Work Top

DKP 30 €
Dijital Koruma Plastiği
Digital Cover

T 217 €
Touch Dijital
Touch Digital

BT 418 €
Wi-Fi Dijital
Wi-Fi Digital

W 90 €
Tekerlekli
Wheels

60hz 56 €
220 V
60 Hz

Model Models	İç Sıcaklık Temperature °C	Brüt Hacim Gross volume Lt.	Ölçüler Dimensions Cm.	Paket Ölçüsü Packing Dim. Cm.	Ağırlık Weight Kg.	Paslanmaz Özelligi Stainless Steel Type
 CGN2-BG-DZ	-2/+8	281	140x70x85	150x80x100	140	304
 CSN2-BG-DZ	-2/+8	250	140x60x85	150x70x100	135	304
 CGN3-BG-DZ	-2/+8	474	186,5x70x85	197x80x100	170	304
 CSN3-BG-DZ	-2/+8	400	186,5x60x85	197x70x100	165	304
CGN4-BG-DZ	-2/+8	632	233x70x85	243x80x100	205	304
CSN4-BG-DZ	-2/+8	550	233x60x85	243x70x100	200	304

İzolasyon Kalınlığı Insulation Thickness	Raf Adedi Shelf Unit	Soğutma Gazı Cooling Gas	Voltaj Voltage	Fiyat Price €	Model Models	Fiyat Price
50 mm	2	R134A	220 V / 50 Hz	2.829 €	CGN2-BG-DZ-R290	2.802 €
50 mm	2	R134A	220 V / 50 Hz	2.755 €	CSN2-BG-DZ-R290	2.729 €
50 mm	3	R134A	220 V / 50 Hz	3.419 €	CGN3-BG-DZ-R290	3.392 €
50 mm	3	R134A	220 V / 50 Hz	3.345 €	CSN3-BG-DZ-R290	3.319 €
50 mm	4	R134A	220 V / 50 Hz	4.098 €	CGN4-BG-DZ-R290	4.071 €
50 mm	4	R134A	220 V / 50 Hz	4.009 €	CSN4-BG-DZ-R290	3.982 €



Dik Buzdolapları - 56 Adet 40x60 Tepsi Kapasite
Vertical Refrigerators - 56 Units 40x60 Tray Capacity

230-231

232-233

Dik Buzdolapları - 112 Adet 40x60 Tepsi Kapasite
Vertical Refrigerators - 112 Units 40x60 Tray Capacity



Pasta Şoklama Dondurucu - 60x80 Kapasite
Cake Shock Freezer - 60x80 Capacity

234-235

236-237

Dik Buzdolapları - 40x60 Tepsi
Vertical Refrigerators - 40x60 Trays



Pizza Buzdolapları 40x60 Tepsi Kapasitesi/Make-Up
Pizza Refrigerators 40x60 Tray Capacity/Make-Up

238-239

240-241

Pizza Buzdolapları 40x60 Tepsi Kapasitesi
Pizza Refrigerators 40x60 Tray Capacity



Pizza Buzdolapları 40x60 Tepsi Kapasitesi/5 Çekmeceli
Pizza Refrigerators 40x60 Tray Capacity/5 Drawers

242-243

244-245

Pizza Buzdolapları 40x60 Tepsi Kapasitesi/3 Çekmece
Pizza Refrigerators 40x60 Tray Capacity/3 Drawers



246-247

Teşhir Buzdolapları
Display Refrigerators



Pizza Buzdolapları 40x60 Tepsi Kapasitesi/Tezgah Tip
Pizza Refrigerators 40x60 Tray Capacity/Counter Type

248-249

250-251

Mayalama Buzdolabı
Retarder Prover Refrigerators



Mayalama Buzdolabı
Retarder Prover Refrigerators

252-253



Dik Buzdolapları - 56 Adet 40x60 Tepsi Kapasite

Vertical Refrigerators - 56 Units 40x60 Tray Capacity



40x60
Tepsi
Tray

Option : 189 €

115 V / 60 Hz

KF



89€

Fanlı Kanopi
Canopy With Fan

28 Adet Raf
Kapasitesi.
4,5 cm Aralıklı.
28 Unit Shelf
Holder Capacity.
4,5 cm Spaced.

İçerde gözüken 40x60 plastik tepsi fiyatı dahil değildir.
The plastic 40x60 trays inside are not included in the price.

VN8-P



FRENOX
PROFESSIONAL REFRIGERATION

40x60 Line Series

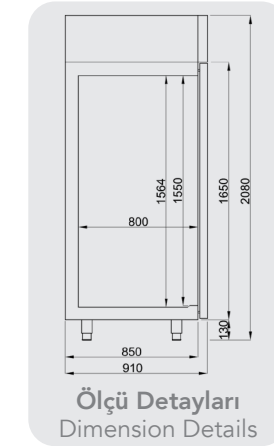

Ölçü Detayları
Dimension Details



Monoblok
Soğutma Sistemi
Monoblock Cooling
Group



Ekstra Kuvvetli Dayanıklı
Fanlar Yüksek Hava Akışı
Strong Fans with maximum
air speed

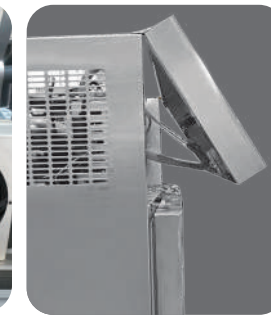

Açılabilir Kanopiyle
Kolay Müdahale Olanığı
Front Cover Can be
Opened For Easy Access

Kod Özellikleri
Available Codes

40x60
Tepsi
Shelf
Tray 56 €

W
Tekerlekli / Wheels 80 €

T
Touch Dijital
Touch Digital 217 €

SE
Görüntü
Appearance 56 €

V
Görüntü
Appearance 56 €

WP
Su Geçirmez Dijital
Water Proof Digital 137 €

BT
Wi-Fi Dijital
Wi-Fi Digital 418 €

L
Sol Kapı
(Dikey)
Left Door
(Upright) 30 €

60hz
220 V
60 hz 56 €

Bilgi

- * İç Derinlik: 40x60 Tepsi Kapasiteli (28 Adet)
- * 35-40 Kg/m³ Gazlı Çevre Dostu HCFC İçermeyen Poliüretan İzolasyon
- * Dijital Kumanda Paneli
- * Otomatik Su Buharlaştırma Sistemi (Elektrikli Rezistans)
- * Elektrikli Otomatik Defrost
- * Yüksekliği Ayarlanabilir Paslanmaz Ayaklar
- * Kapı Açıldığında Otomatik İç Aydınlatma
- * Özel, Kapı Menteşe Sistemi
- * Temizlenebilir ve Sökülebilir Manyetik Kapı Contası
- * Dış Ortam Sıcaklığı: + 32°C & % 50 Nem

Info

- * Inside Depth: 40x60 Tray Capacity (28 Units)
- * 35-40 Kg/m³ Ecology Friendly HCFC Free Polyurethane Insulation
- * Digital Control Panel
- * Automatic Water Evaporation System (Electrical Resistor)
- * Electrical Automatic Defrost
- * Stainless Steel Legs Adjustable For Height
- * Automatic Lighting Inside When Door is Open
- * Special Door and Hinge Systems
- * Removable and Easy Cleaning Magnetic Gaskets
- * Ambient Temperature: + 32°C & % 50 Humidity

Model Models	İç Sıcaklık Temperature °C	Brüt Hacim Gross volume Lt.	Ölçüler Dimensions Cm.	Paket Ölçüsü Packing Dim. Cm.	Ağırlık Weight Kg.	Paslanmaz Özelliği Stainless Steel Type
	VN8-P	-2/+8	850	82x92x208	90x101x225	169 304
	VL8-P	-10/-20	850	82x92x208	90x101x225	176 304
	BN8-P	-2/+8	850	82x92x208	90x101x225	169 430
	BL8-P	-10/-20	850	82x92x208	90x101x225	176 430
	VN8-P-G	-2/+8	850	82x92x208	90x101x225	176 304
	VL8-P-G	-10/-20	850	82x92x208	90x101x225	190 304
	BN8-P-G	-2/+8	850	82x92x208	90x101x225	176 430
	BL8-P-G	-10/-20	850	82x92x208	90x101x225	190 430

İzolasyon Kalınlığı Insulation Thickness	Raf Kızağı Shelf Holder	Soğutma Gazı Cooling Gas	Voltaj Voltage	Enerji Sınıfı Energy Rating	Kapı Adedi Door Unit	Model Models	Fiyat Price
80 mm	28	R290	220 V / 50 Hz	E	1	VN8-P-R290	2.655 €
80 mm	28	R290	220 V / 50 Hz	E	1	VL8-P-R290	3.339 €
80 mm	28	R290	220 V / 50 Hz	E	1	BN8-P-R290	2.355 €
80 mm	28	R290	220 V / 50 Hz	E	1	BL8-P-R290	3.082 €
80 mm	28	R290	220 V / 50 Hz	E	1	VN8-P-G-R290	2.755 €
80 mm	28	R290	220 V / 50 Hz	E	1	VL8-P-G-R290	3.539 €
80 mm	28	R290	220 V / 50 Hz	E	1	BN8-P-G-R290	2.455 €
80 mm	28	R290	220 V / 50 Hz	E	1	BL8-P-G-R290	3.282 €

EF: Bu modellerde energy efficiency kondenser fanı kullanılmaktadır. / These models have energy efficiency condenser fans.

Dik Buzdolapları - 112 Adet 40x60 Tepsi Kapasite

Vertical Refrigerators - 112 Units 40x60 Tray Capacity



VN16-P

40x60
Tepsi
Tray

Option : 189 €

115 V / 60 Hz

28 Adet Raf
Kapasitesi.
4,5 cm Aralıklı.
28 Unit Shelf
Holder Capacity.
4,5 cm Spaced.

KF



89€

Fanlı Kanopi
Canopy With Fan

İçerde gözükken 40x60 plastik tepsi fiyatı dahil değildir.
The plastic 40x60 trays inside are not included in the price.



FRENOX
PROFESSIONAL REFRIGERATION

40x60 Line Series

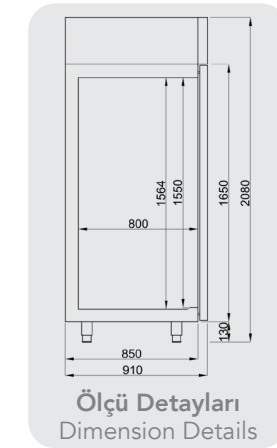

Ölçü Detayları
Dimension Details



Monoblok
Soğutma Sistemi
Monoblock Cooling
Group



Ekstra Kuvvetli Dayanıklı
Fanlar Yüksek Hava Akışı
Strong Fans with maximum
air speed

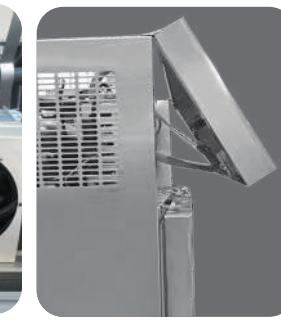

Açılabilir Kanopiyle
Kolay Müdahale Olanığı
Front Cover Can be
Opened For Easy Access

Kod Özellikleri Available Codes

40x60
Tepsi
Shelf
Tray 56 €

W
Tekerlekli / Wheels 90 €

T
Touch Dijital
Touch Digital 217 €

SE
Görüntü
Appearance 56 €

V
Görüntü
Appearance 56 €

WP
Su Geçirmez Dijital
Water Proof Digital 137 €

BT
Wi-Fi Dijital
Wi-Fi Digital 418 €

L
Sol Kapı
(Dikey)
Left Door
(Upright) 30 €

60hz
220 V
60 Hz 56 €

Bilgi

- * İç Derinlik: 40x60 Tepsi Kapasiteli (28 Adet)
- * 35-40 Kg/m³ Gazlı Çevre Dostu HCFC İçermeyen Poliüretan İzolasyon
- * Dijital Kumanda Paneli
- * Otomatik Su Buharlaştırma Sistemi (Elektrikli Rezistans)
- * Elektrikli Otomatik Defrost
- * Yüksekliği Ayarlanabilir Paslanmaz Ayaklar
- * Kapı Açıldığında Otomatik İç Aydınlatma
- * Özel, Kapı Menteşe Sistemi
- * Temizlenebilir ve Sökülebilir Manyetik Kapı Contası
- * Dış Ortam Sıcaklığı: + 32°C & % 50 Nem

Info

- * Inside Depth: 40x60 Tray Capacity (28 Units)
- * 35-40 Kg/m³ Ecology Friendly HCFC Free Polyurethane Insulation
- * Digital Control Panel
- * Automatic Water Evaporation System (Electrical Resistor)
- * Electrical Automatic Defrost
- * Stainless Steel Legs Adjustable For Height
- * Automatic Lighting Inside When Door is Open
- * Special Door and Hinge Systems
- * Removable and Easy Cleaning Magnetic Gaskets
- * Ambient Temperature: + 32°C & % 50 Humidity

Model Models	İç Sıcaklık Temperature °C	Brüt Hacim Gross volume Lt.	Ölçüler Dimensions Cm.	Paket Ölçüsü Packing Dim. Cm.	Ağırlık Weight Kg.	Paslanmaz Özelligi Stainless Steel Type
	VN16-P	-2/+8	1700	172x101x211	182x110x232	300 / 304
	VL16-P	-10/-20	1700	172x101x211	182x110x232	310 / 304
	BN16-P	-2/+8	1700	172x101x211	182x110x232	300 / 430
	BL16-P	-10/-20	1700	172x101x211	182x110x232	310 / 430
	VN16-P-G	-2/+8	1700	172x101x211	182x110x232	330 / 304
	VL16-P-G	-10/-20	1700	172x101x211	182x110x232	350 / 304
	BN16-P-G	-2/+8	1700	172x101x211	182x110x232	330 / 430
	BL16-P-G	-10/-20	1700	172x101x211	182x110x232	350 / 430

İzolasyon Kalınlığı Insulation Thickness	Raf Kızağı Shelf Holder	Soğutma Gazı Cooling Gas	Voltaj Voltage	Enerji Sınıfı Energy Rating	Kapı Adedi Door Unit	Fiyat Price €	Model Models	Fiyat Price
80 mm	56	R134A	220 V / 50 Hz	E	2	6.309 €	VN16-P-R290	6.281 €
80 mm	56	R404A	220 V / 50 Hz	E	2	7.395 €	VL16-P-R290	7.168 €
80 mm	56	R134A	220 V / 50 Hz	E	2	5.351 €	BN16-P-R290	5.325 €
80 mm	56	R404A	220 V / 50 Hz	E	2	6.508 €	BL16-P-R290	6.281 €
80 mm	56	R134A	220 V / 50 Hz	E	2	7.136 €	VN16-P-G-R290	7.108 €
80 mm	56	R404A	220 V / 50 Hz	E	2	8.163 €	VL16-P-G-R290	7.936 €
80 mm	56	R134A	220 V / 50 Hz	E	2	6.512 €	BN16-P-G-R290	6.486 €
80 mm	56	R404A	220 V / 50 Hz	E	2	7.494 €	BL16-P-G-R290	7.267 €

EF: Bu modellerde energy efficiency kondenser fanı kullanılmaktadır. / These models have energy efficiency condenser fans.

Pasta Şoklama Dondurucu - 60x80 Kapasite

Cake Shock Freezer - 60x80 Capacity



PSL9-W

40x60
Tepsi
Tray

Option : 189 €

115 V / 60 Hz

-30°C

KF



89€

Fanlı Kanopi
Canopy With Fan

28 Adet Raf
Kapasitesi.
4,5 cm Aralıklı.
28 Unit Shelf
Holder Capacity.
4,5 cm Spaced.

İçerde gözüken 40x60 plastik tepsiler fiyata dahil değildir.
The plastic 40x60 trays inside are not included in the price.



FRENOX
PROFESSIONAL REFRIGERATION

40x60 Line Series

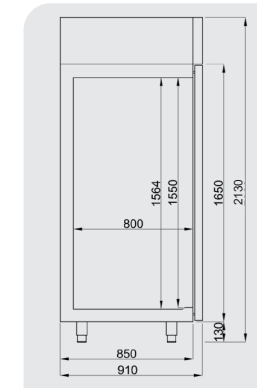

Ölçü Detayları
Dimension Details



Açılabilir Kanopiyle
Kolay Müdahale Olanağı
Front Cover Can be
Opened For Easy Access

Kod Özellikleri
Available Codes

40x60
Tepsi
Shelf
Tray 56 €

W
Tekerlekli / Wheels 90 €

T
Touch Dijital
Touch Digital 217 €

V
Görüntü
Appearance 56 €

WP
Su Geçirmez Dijital
Water Proof Digital 137 €

BT
Wi-Fi Dijital
Wi-Fi Digital 418 €

L
Sol Kapı
(Dikey)
Left Door
(Upright) 30 €

60_{hz}
220 V
60 hz 56 €



Bilgi

- * İç Derinlik: 40x60 Tepsi Kapasiteli (28 Adet)
- * 35-40 Kg/m³ Gazlı Çevre Dostu HCFC İçermeyen Poliüretan İzolasyon
- * Dijital Kumanda Paneli
- * Otomatik Su Buharlaştırma Sistemi (Elektrikli Rezistans)
- * Elektrikli Otomatik Defrost
- * Yüksekliği Ayarlanabilir Paslanmaz Ayaklar
- * Kapı Açıldığında Otomatik İç Aydınlatma
- * Özel, Kapı Menteşe Sistemi
- * Temizlenebilir ve Sökülebilir Manyetik Kapı Contası
- * Dış Ortam Sıcaklığı: + 32°C & % 50 Nem

Info

- * Inside Depth: 40x60 Tray Capacity (28 Units)
- * 35-40 Kg/m³ Ecology Friendly HCFC Free Polyurethane Insulation
- * Digital Control Panel
- * Automatic Water Evaporation System (Electrical Resistor)
- * Electrical Automatic Defrost
- * Stainless Steel Legs Adjustable For Height
- * Automatic Lighting Inside When Door is Open
- * Special Door and Hinge Systems
- * Removable and Easy Cleaning Magnetic Gaskets
- * Ambient Temperature: + 32°C & % 50 Humidity

İzolasyon Kalınlığı Insulation Thickness	Raf Adedi Shelf Unit	Soğutma Gazı Cooling Gas	Voltaj Voltage	Fiyat Price €	Model Models	Fiyat Price
80 mm	9	R404	220 V / 50 Hz	6.604 €	PSL-9-R290	6.577 €
80 mm	9	R404	220 V / 50 Hz	10.372 €	PSL-18-R290	10.344 €

Model Models	İç Sıcaklık Temperature °C	Brüt Hacim Gross volume Lt.	Ölçüler Dimensions Cm.	Paket Ölçüsü Packing Dim. Cm.	Ağırlık Weight Kg.	Paslanmaz Özelliği Stainless Steel Type
 PSL9	-10/-30	850	90x103x213	100x109x230	245	304
 PSL18	-10/-30	1700	180x103x213	190x109x230	395	304

Dik Buzdolapları - 40x60 Tepsi

Vertical Refrigerators - 40x60 Trays



40x60
Tepsi
Tray

Option : 189 €

115 V / 60 Hz

KF



89€

Fanlı Kanopi
Canopy With Fan

İçerde gözükten 40x60 plastik tepsi fiyatı dahil değildir.
The plastic 40x60 trays inside are not included in the price.

VN7-P-G



FRENOX
PROFESSIONAL REFRIGERATION

40x60 Line Series

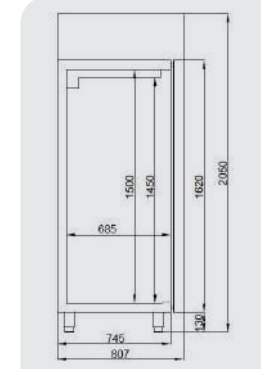

Ölçü Detayları
Dimension Details

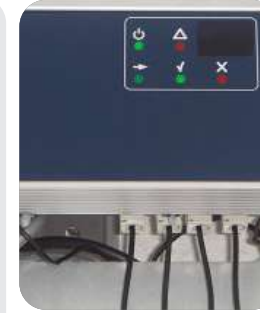

Her Ürün İçin
10 Saatlik
Performans Testi
10 Hours
performance testing



Değiştirilebilir Arasında Kir
ve Bakteri Tutmayan Yüksek
Manyetik Çekimli ÖZEL
Conta
Special designed new gaskets.
Can be removed, dirt-free

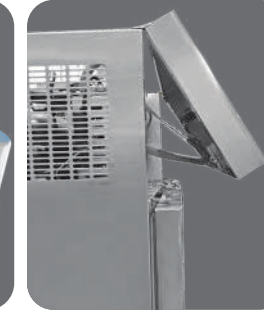

Açılabilir Kanopiyle
Kolay Müdahale Olanağı
Front Cover Can be
Opened For Easy Access

Kod Özellikleri
Available Codes

40x60
Tepsi
Shelf
Tray 56 €

W
Tekerlekli / Wheels 90 €

T
Touch Dijital
Touch Digital 217 €

SE
Görüntü
Appearance 56 €

V
Görüntü
Appearance 56 €

WP
Su Geçirmez Dijital
Water Proof Digital 137 €

-2
Yarım Kapı
Half Door 192 €

BT
Wi-Fi Dijital
Wi-Fi Digital 418 €

L
Sol Kapı
(Dikey)
Left Door
(Upright) 30 €

60hz
220 V
60 Hz 56 €

Bilgi

- * İç Derinlik: 40x60 Tepsi Kapasiteli
- * 335-40 Kg/m³ Gazlı Çevre Dostu HCFC İçermeyen Poliüretan İzolasyon
- * Dijital Kumanda Paneli
- * Otomatik Su Buharlaştırma Sistemi (Elektrikli Rezistans)
- * Elektrikli Otomatik Defrost
- * Yüksekliği Ayarlanabilir Paslanmaz Ayaklar
- * Kapı Açıldığında Otomatik İç Aydınlatma
- * Özel, Kapı Menteşe Sistemi
- * Temizlenebilir ve Sökülebilir Manyetik Kapı Contası
- * Dış Ortam Sıcaklığı: + 43oC & % 65 Nem

Info

- * Inside Depth: 40x60 Tray Capacity
- * 35-40 Kg/m³ Ecology Friendly HCFC Free Polyurethane Insulation
- * Digital Control Panel
- * Automatic Water Evaporation System (Electrical Resistor)
- * Electrical Automatic Defrost
- * Stainless Steel Legs Adjustable For Height
- * Automatic Lighting Inside When Door is Open
- * Special Door and Hinge Systems
- * Removable and Easy Cleaning Magnetic Gaskets
- * Ambient Temperature: + 43oC & % 65 Humidity

Model Models	İç Sıcaklık Temperature °C	Brüt Hacim Gross volume Lt.	Ölçüler Dimensions Cm.	Paket Ölçüsü Packing Dim. Cm.	Ağırlık Weight Kg.	Paslanmaz Özellikçi Stainless Steel Type	
	VN7-P	-2/+8	700	70x81x205	80x85x220	138	304
	VL7-P	-10/-22	700	70x81x205	80x85x220	143	304
	VN7-P-G	-2/+8	700	70x81x205	80x85x220	143	304
	VL7-P-G	-10/-22	700	70x81x205	80x85x220	165	304
	VN14-P	-2/+8	1400	140x81x205	150x85x220	217	304
	VL14-P	-10/-22	1400	140x81x205	150x85x220	231	304
	VN14-P-G	-2/+8	1400	140x81x205	150x85x220	227	304
	VL14-P-G	-10/-22	1400	140x81x205	150x85x220	260	304

G : Cam Kapı / G : Glass Door

İzolasyon Kalınlığı Insulation Thickness	Raf Kızağı Shelf Holder	Soğutma Gazı Cooling Gas	Voltaj Voltage	Enerji Sınıfı Energy Rating	Kapı Adedi Door Unit	Fiyat Price €
60 mm	10	R134A	220 V / 50 Hz	E	1	2.910 €
60 mm	10	R404A	220 V / 50 Hz	E	1	3.422 €
60 mm	10	R134A	220 V / 50 Hz	E	1	3.382 €
60 mm	10	R404A	220 V / 50 Hz	E	1	3.995 €
60 mm	20	R134A	220 V / 50 Hz	D	2	4.232 €
60 mm	20	R404A	220 V / 50 Hz	E	2	5.708 €
60 mm	20	R134A	220 V / 50 Hz	D	2	5.140 €
60 mm	20	R404A	220 V / 50 Hz	E	2	6.972 €

Pizza Buzdolapları 40x60 Tepsi Kapasitesi/Make-Up

Pizza Refrigerators 40x60 Tray Capacity/Make-Up

GN 1/3

KF



153€

Fanlı Kanopi
Canopy With Fan

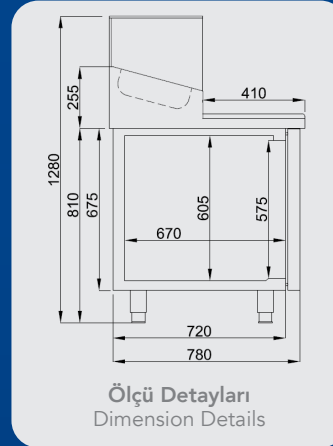

Ölçü Detayları
Dimension Details

Option : 189 €

115 V / 60 Hz



PMN-155

Gastronom kaplar fiyata dahil değildir.
Gastronom cups are not included in the price.

Sadece Raf Kızakları Mevcuttur.
Only Shelf Rails are Included.

40x60 Tepsiler fiyata dahil değildir.
40x60 Trays are not included in the price.

8 Adet Raf Kapasitesi.
6 cm Aralıklı.
8 Unit Shelf Holder Capacity.
6 cm Spaced.



FRENOX
PROFESSIONAL REFRIGERATION

40x60 Line Series

Çekmece Seçenekleri / Drawer Options



3D 1/3 Çekmece - 1/3 Drawers 658 €

2D 1/2 Çekmece - 1/2 Drawers 551 €

Bilgi





- * İç Derinlik: 63 Cm (40x60 Tepsi Kapasiteli)
- * 35-40 Kg/m³ Çevre Dostu HCFC İçermeyen Poliüretan İzolasyon
- * Dijital Kumanda Paneli
- * Elektrik Rezistanslı Otomatik Defrost
- * Yüksekliği Ayarlanabilir Paslanmaz Ayaklar
- * Özel Kapı ve Menteşe Sistemi
- * Temizlenebilir ve Sökülebilir Manyetik Kapı Contası
- * Dış Ortam Sıcaklığı + 43 °C & % 65 Nem
- * GN 1/3x150 Kapasiteli Statik Soğutma Make-Up
- * Mermer Üst Tabla
- * Cam Kapak Make-Up Üstünde

Info

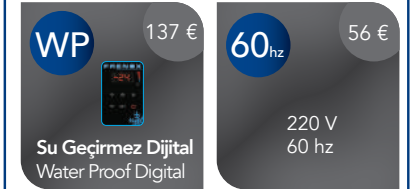
- * Inside Depth: 63 Cm (40x60 Tray Capacity)
- * 35-40 Kg/m³ Ecology Friendly HCFC Free Polyurethane Insulation
- * Digital Control Panel
- * Electrical Resistor Automatic Defrost
- * Stainless Steel Legs Adjustable for Height
- * Special Door and Hinge Systems
- * Removable and Easy Cleaning Magnetic Gasket
- * Ambient Temperature + 43 °C & % 65 Humidity
- * GN 1/3x150 Capacity Static Cooled Make-Up
- * Marble Top Front Work Top
- * Glass Cover over Make-Up

Kod Özellikleri Available Codes



Model Models	İç Sıcaklık Temperature °C	Brüt Hacim Gross volume Lt.	Ölçüler Dimensions Cm.	Paket Ölçüsü Packing Dim. Cm.	Ağırlık Weight Kg.	Paslanmaz Özellikli Stainless Steel Type
 PMN-155	-2/+8	380	155x80x128	165x90x125	160	304
 BMN-155	-2/+8	380	155x80x128	165x90x125	160	430
 PMN-210	-2/+8	615	210x80x128	220x90x125	180	304
 BMN-210	-2/+8	615	210x80x128	220x90x125	180	430

İzolasyon Kalınlığı Insulation Thickness	Raf Kızağı Takımı Shelf Rails Pair	Soğutma Gazı Cooling Gas	Voltaj Voltage	Fiyat Price €	Model Models	Fiyat Price
50 mm	6 Shelf Rails	R134A	220 V / 50 Hz	4.062 €	PMN-155-R290	4.034 €
50 mm	6 Shelf Rails	R134A	220 V / 50 Hz	3.105 €	BMN-155-R290	3.079 €
50 mm	9 Shelf Rails	R134A	220 V / 50 Hz	4.549 €	PMN-210-R290	4.522 €
50 mm	9 Shelf Rails	R134A	220 V / 50 Hz	3.721 €	BMN-210-R290	3.695 €

Pizza Buzdolapları 40x60 Tepsi Kapasitesi

Pizza Refrigerators 40x60 Tray Capacity



PZT 155 DSP 155

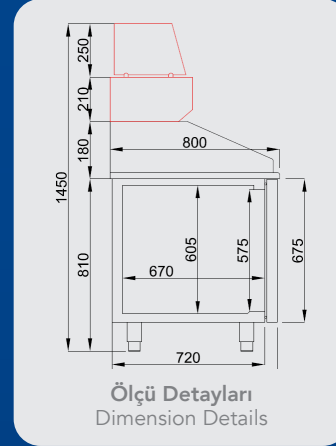

Option : 189 €

115 V / 60 Hz

8 Adet Raf Kapasitesi. 6 cm Aralıklı. 8 Unit Shelf Holder Capacity. 6 cm Spaced.

Teşhir ünitesi (DSP) ve pizza dolapları (PZT) ayrı satılmaktadır. Pizza display (DSP) and Pizza refrigerator (PZT) are sold separately.

Gastronom kaplar fiyata dahil değildir. Gastronom cups are not included in the price.

Sadece Raf Kızakları Mevcuttur. Only Shelf Rails are Included.



40x60 Line Series

Çekmece Seçenekleri / Drawer Options



3D 1/3 Çekmece - 1/3 Drawers 658 €

2D 1/2 Çekmece - 1/2 Drawers 551 €

Bilgi

- * İç Derinlik: 63 Cm (40x60 Tepsi Kapasiteli)
- * 35-40 Kg/m³ Çevre Dostu HCFC İçermeyen Poliüretan İzolasyon
- * Dijital Kumanda Paneli
- * Elektrik Rezistanslı Otomatik Defrost
- * Özel Su Buharlaştırma Sistemi
- * Yüksekliği Ayarlanabilir Paslanmaz Ayaklar
- * Özel, Kapı Mentеше Sistemi
- * Temizlenebilir ve Sökülebilir Manyetik Kapı Contası
- * Dış Ortam Sıcaklığı: + 43°C & % 65 Nem

Info

- * Inside Depth: 63 Cm (40x60 Tray Capacity)
- * 35-40 Kg/m³ Ecology Friendly HCFC Free Polyurethane Insulation
- * Digital Control Panel
- * Electrical Resistor Automatic Defrost
- * Special Water Evaporation
- * Stainless Steel Legs Adjustable For Height
- * Special Door and Hinge Systems
- * Removable and Easy Cleaning Magnetic Gaskets
- * Ambient Temperature: + 43°C %65 Humidity

Kod Özellikleri Available Codes

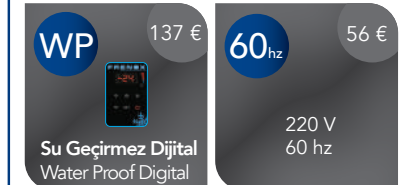

Model Models	İç Sıcaklık Temperature °C	Brüt Hacim Gross volume Lt.	Ölçüler Dimensions Cm.	Paket Ölçüsü Packing Dim. Cm.	Ağırlık Weight Kg.	Paslanmaz Özelliği Stainless Steel Type
	BZT 155	-2/+8	380	155x80x108	165x90x125	232 430
	PZT 155	-2/+8	380	155x80x108	165x90x125	232 304
	BZT 210	-2/+8	615	210x80x108	220x90x125	311 430
	PZT 210	-2/+8	615	210x80x108	220x90x125	311 304
	DSP 155	+4/+10	6 Ad. GN1/3	155x39x46	168x54x55	67 304
	DSP 210	+4/+10	10 Ad. GN1/3	210x39x46	233x54x55	108 304

İzolasyon Kalınlığı Insulation Thickness	Raf Kızağı Takımı Shelf Rails Pair	Soğutma Gazı Cooling Gas	Voltaj Voltage	Fiyat Price €	Model Models	Fiyat Price
50 mm	6 Shelf Rails	R134A	220 V / 50 Hz	3.400 €	BZT 155-R290	3.374 €
50 mm	6 Shelf Rails	R134A	220 V / 50 Hz	3.921 €	PZT 155-R290	3.893 €
50 mm	9 Shelf Rails	R134A	220 V / 50 Hz	3.998 €	BZT 210-R290	3.971 €
50 mm	9 Shelf Rails	R134A	220 V / 50 Hz	4.609 €	PZT 210-R290	4.581 €
50 mm	-	R290	220 V / 50 Hz	1.537 €		
50 mm	-	R290	220 V / 50 Hz	1.610 €		

Pizza Buzdolapları 40x60 Tepsi Kapasitesi/5 Çekmeceli

Pizza Refrigerators 40x60 Tray Capacity/5 Drawers

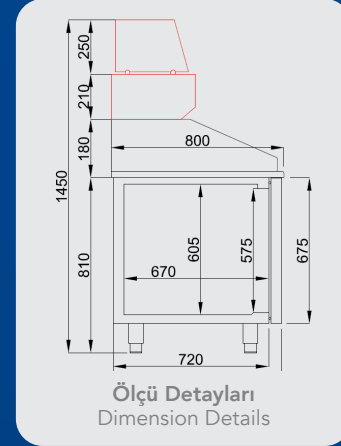

Option : 189 €

115 V / 60 Hz

Teşhir ünitesi (DSP) ve pizza dolapları (PZT) ayrı satılmaktadır.
Pizza display (DSP) and Pizza refrigerator (PZT) are sold separately.

Gastronom kaplar fiyata dahil değildir.
Gastronom cups are not included in the price.

Sadece Raf Kızakları Mevcuttur.
Only Shelf Rails are Included.

8 Adet Raf Kapasitesi.
6 cm Aralıklı.
8 Unit Shelf Holder Capacity.
6 cm Spaced.

PZT 155D DSP 155



40x60 Line Series

Çekmece Seçenekleri / Drawer Options



3D 1/3 Çekmece - 1/3 Drawers 658 €

2D 1/2 Çekmece - 1/2 Drawers 551 €

Bilgi

- * İç Derinlik: 63 Cm (40x60 Tepsi Kapasiteli)
- * 35-40 Kg/m³ Çevre Dostu HCFC İçermeyen Poliüretan İzolasyon
- * Dijital Kumanda Paneli
- * Elektrik Rezistanslı Otomatik Defrost
- * Özel Su Buharlaştırma Sistemi
- * Yüksekliği Ayarlanabilir Paslanmaz Ayaklar
- * Özel, Kapı Mentеше Sistemi
- * Temizlenebilir ve Sökülebilir Manyetik Kapı Contası
- * Dış Ortam Sıcaklığı: + 43°C & % 65 Nem

Info

- * Inside Depth: 63 Cm (40x60 Tray Capacity)
- * 35-40 Kg/m³ Ecology Friendly HCFC Free Polyurethane Insulation
- * Digital Control Panel
- * Electrical Resistor Automatic Defrost
- * Special Water Evaporation
- * Stainless Steel Legs Adjustable For Height
- * Special Door and Hinge Systems
- * Removable and Easy Cleaning Magnetic Gaskets
- * Ambient Temperature: + 43°C %65 Humidity

Kod Özellikleri Available Codes

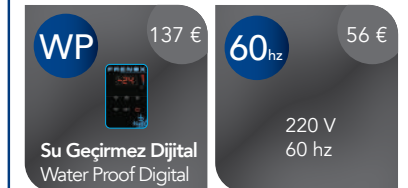

Model Models	İç Sıcaklık Temperature °C	Brüt Hacim Gross volume Lt.	Ölçüler Dimensions Cm.	Paket Ölçüsü Packing Dim. Cm.	Ağırlık Weight Kg.	Paslanmaz Özelligi Stainless Steel Type
BZT 155-D	-2/+8	380	155x80x108	165x90x125	236	430
PZT 155-D	-2/+8	380	155x80x108	165x90x125	232	304
BZT 210-D	-2/+8	615	210x80x108	220x90x125	311	430
PZT 210-D	-2/+8	615	210x80x108	220x90x125	311	304
DSP 155	+4/+10	6 Ad. GN1/3	155x39x46	168x54x55	67	304
DSP 210	+4/+10	10 Ad. GN1/3	210x39x46	233x54x55	105	304

İzolasyon Kalınlığı Insulation Thickness	Raf Kızağı Takımı Shelf Rails Pair	Soğutma Gazı Cooling Gas	Voltaj Voltage	Fiyat Price €	Model Models	Fiyat Price €
50 mm	3 Shelf Rail	R134A	220 V / 50 Hz	3.562 €	BZT 155-D-R290	3.536 €
50 mm	3 Shelf Rail	R134A	220 V / 50 Hz	4.092 €	PZT 155-D-R290	4.065 €
50 mm	6 Shelf Rail	R134A	220 V / 50 Hz	4.237 €	BZT 210-D-R290	4.211 €
50 mm	6 Shelf Rail	R134A	220 V / 50 Hz	4.889 €	PZT 210-D-R290	4.861 €
50 mm	-	R290	220 V / 50 Hz	1.537 €		
50 mm	-	R290	220 V / 50 Hz	1.610 €		

Pizza Buzdolapları 40x60 Tepsi Kapasitesi/3 Çekmeceli

Pizza Refrigerators 40x60 Tray Capacity/3 Drawers



40x60 Line Series

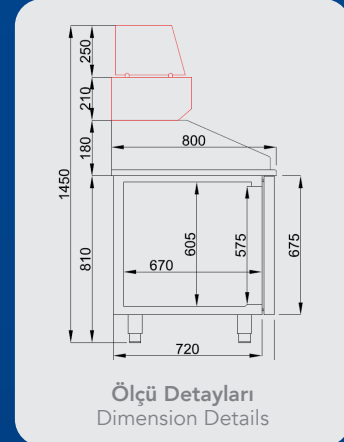

Option : 189 €

115 V / 60 Hz

Teşhir ünitesi (DSP) ve pizza dolapları (PZT) ayrı ayrı satılmaktadır.
Pizza display (DSP) and Pizza refrigerator (PZT) are sold separately.

Gastronom kaplar fiyata dahil değildir.
Gastronom cups are not included in the price.

Sadece Raf Kızakları Mevcuttur.
Only Shelf Rails are Included.

8 Adet Raf Kapasitesi.
6 cm Aralıklı.
8 Unit Shelf Holder Capacity.
6 cm Spaced.

PZT 160-3D DSP 160

Çekmece Seçenekleri / Drawer Options



3D 1/3 Çekmece - 1/3 Drawers 658 €

2D 1/2 Çekmece - 1/2 Drawers 551 €

Bilgi

- * İç Derinlik: 63 Cm (40x60 Tepsi Kapasiteli)
- * 35-40 Kg/m³ Çevre Dostu HCFC İçermeyen Poliüretan İzolasyon
- * Dijital Kumanda Paneli
- * Elektrik Rezistanslı Otomatik Defrost
- * Özel Su Buharlaştırma Sistemi
- * Yüksekliği Ayarlanabilir Paslanmaz Ayaklar
- * Özel, Kapı Menteşe Sistemi
- * Temizlenebilir ve Sökülebilir Manyetik Kapı Contası
- * Dış Ortam Sıcaklığı: + 43°C & % 65 Nem

Info

- * Inside Depth: 63 Cm (40x60 Tray Capacity)
- * 35-40 Kg/m³ Ecology Friendly HCFC Free Polyurethane Insulation
- * Digital Control Panel
- * Electrical Resistor Automatic Defrost
- * Special Water Evaporation
- * Stainless Steel Legs Adjustable For Height
- * Special Door and Hinge Systems
- * Removable and Easy Cleaning Magnetic Gaskets
- * Ambient Temperature: + 43°C %65 Humidity

Kod Özellikleri Available Codes

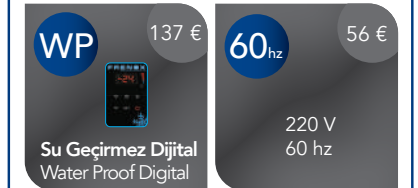

Model Models	İç Sıcaklık Temperature °C	Brüt Hacim Gross volume Lt.	Ölçüler Dimensions Cm.	Paket Ölçüsü Packing Dim. Cm.	Ağırlık Weight Kg.	Paslanmaz Özelliği Stainless Steel Type
BZT 160-3D	-2/+8	380	160x80x108	170x90x125	286	430
PZT 160-3D	-2/+8	380	160x80x108	170x90x125	286	304
BZT 215-3D	-2/+8	615	215x80x108	225x90x125	311	430
PZT 215-3D	-2/+8	615	215x80x108	225x90x125	311	304
DSP 160	+4/+10	6 Ad. GN1/3	160x39x46	173x53x55	311	304
DSP 215	+4/+10	10 Ad. GN1/3	215x39x46	228x53x55	108	304

İzolasyon Kalınlığı Insulation Thickness	Raf Kızağı Takımı Shelf Rails Pair	Soğutma Gazı Cooling Gas	Voltaj Voltage	Fiyat Price €	Model Models	Fiyat Price
50 mm	6 Shelf Rail	R134A	220 V / 50 Hz	3.640 €	BZT 160-3D-R290	3.613 €
50 mm	6 Shelf Rail	R134A	220 V / 50 Hz	4.194 €	PZT 160-3D-R290	4.167 €
50 mm	9 Shelf Rail	R134A	220 V / 50 Hz	4.210 €	BZT 215-3D-R290	4.183 €
50 mm	9 Shelf Rail	R134A	220 V / 50 Hz	4.921 €	PZT 215-3D-R290	4.893 €
50 mm	-	R290	220 V / 50 Hz	1.559 €		
50 mm	-	R290	220 V / 50 Hz	1.626 €		

Teşhir Buzdolapları Display Refrigerators

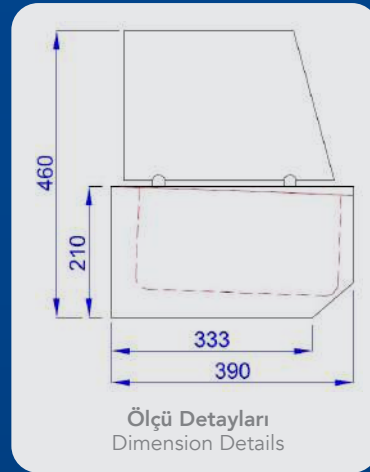

Option : 189 €

115 V / 60 Hz

Gastronom kaplar fiyata dahil değildir.

Gastronom cups are not included in the price.

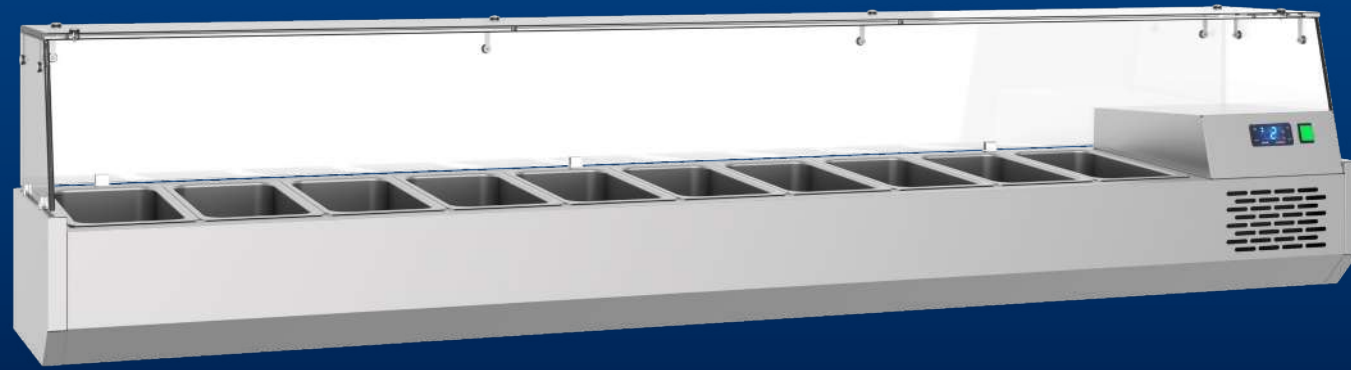

DSP 210



FRENOX
PROFESSIONAL REFRIGERATION

40x60 Line Series

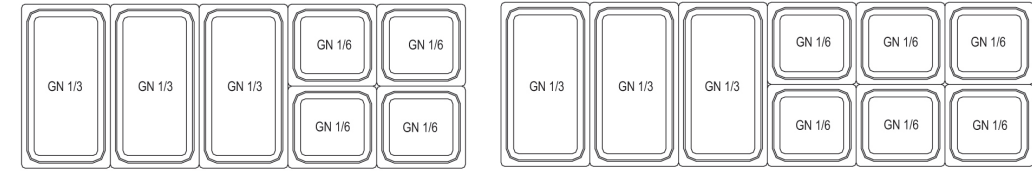

DSP-140

DSP-155

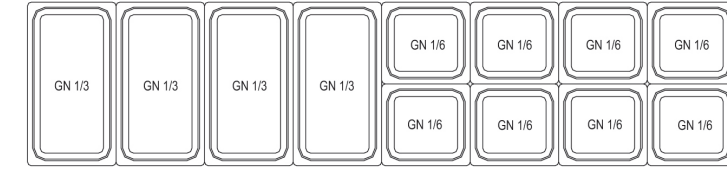

DSP-186

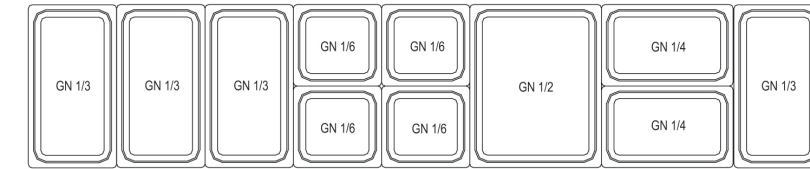

DSP-210

Bilgi

- * İç Derinlik: 150 mm Gastronom Kapa Uygun
- * 35-40 Kg/m³ Çevre Dostu HCFC İçermeyen Poliüretan İzolasyon
- * Dijital Termometre & Termostat
- * Statik Soğutma
- * Yüksekliği Ayarlanabilir Ayaklar
- * Sökülebilir Üst Cam
- * Dış Ortam Sıcaklığı: + 32°C

Info

- * Inside Depth: Suitable for 150 mm GnCups
- * 35-40 Kg/m³ Ecology Friendly HCFC Free Polyurethane Insulation
- * Digital Thermometer & Thermostat
- * Static Cooling
- * Legs Adjustable For Height
- * Removable Glass Cover
- * Ambient Temperature: + 32°C

Kod Özellikleri Available Codes



Model Models	İç Sıcaklık Temperature °C	Brüt Hacim Gross volume Lt.	Ölçüler Dimensions Cm.	Paket Ölçüsü Packing Dim. Cm.	Ağırlık Weight Kg.
DSP 100	+4/+10	4 Ad. GN1/3	100x39x46	113x53x53	50
DSP 140	+4/+10	6 Ad. GN1/3	140x39x46	153x53x53	65
DSP 155	+4/+10	6 Ad. GN1/3	155x39x46	168x53x53	70
DSP 160	+4/+10	7 Ad. GN1/3	160x39x46	173x53x53	75
DSP 186	+4/+10	8 Ad. GN1/3	186,5x39x46	199x53x53	84
DSP 210	+4/+10	10 Ad. GN1/3	210x39x46	223x53x53	105
DSP 215	+4/+10	10 Ad. GN1/3	215x39x46	228x53x53	110

Paslanmaz Özelliği Stainless Steel Type	İzolasyon Kalınlığı Insulation Thickness	Soğutma Gazı Cooling Gas	Voltaj Voltage	Fiyat Price €
304	50 mm	R290	220 V / 50 Hz	1.396 €
304	50 mm	R290	220 V / 50 Hz	1.434 €
304	50 mm	R290	220 V / 50 Hz	1.537 €
304	50 mm	R290	220 V / 50 Hz	1.559 €
304	50 mm	R290	220 V / 50 Hz	1.588 €
304	50 mm	R290	220 V / 50 Hz	1.610 €
304	50 mm	R290	220 V / 50 Hz	1.626 €

Pizza Buzdolapları 40x60 Tepsi Kapasitesi/Tezgah Tipi

Pizza Refrigerators 40x60 Tray Capacity/Counter Type



FRENOX
PROFESSIONAL REFRIGERATION

40x60 Line Series

8 Adet Raf Kapasitesi.
6 cm Aralıklı.
8 Unit Shelf Holder Capacity.
6 cm Spaced.

KF
153€
Fanlı Kanopi
Canopy With Fan

Derin Dondurucularda
Kanopide Fan Mevcuttur.
Deep Freezers Have Fan
On The Canopy

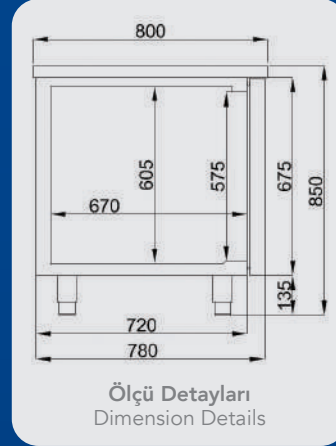

Option : 189 €

115 V / 60 Hz



PPN3-DZ

Sadece Raf Kızakları
Mevcuttur.
Only Shelf Rails are
Included.

40x60 Tepsiler fiyata
dahil değildir.
40x60 Trays are not
included in the price.

Çekmece Seçenekleri / Drawer Options



3D 1/3 Çekmece - 1/3 Drawers 658 €

2D 1/2 Çekmece - 1/2 Drawers 551 €

Bilgi

- * İç Derinlik: 63 Cm (40x60 Tepsi Kapasiteli)
- * 35-40 Kg/m³ Çevre Dostu HCFC İçermeyen Poliüretan İzolasyon
- * Dijital Kumanda Paneli
- * Elektrik Rezistanslı Otomatik Defrost
- * Yüksekliği Ayarlanabilir Paslanmaz Ayaklar
- * Özel Kapı ve Menteşe Sistemi
- * Temizlenebilir ve Sökülebilir Manyetik Kapı Contası
- * Dış Ortam Sıcaklığı + 43 °C & % 65 Nem
- * GN 1/3x150 Kapasiteli Statik Soğutma Make-Up
- * Mermer Üst Tabla
- * Cam Kapak Make-Up Üstünde

Info

- * Inside Depth: 63 Cm (40x60 Tray Capacity)
- * 35-40 Kg/m³ Ecology Friendly HCFC Free Polyurethane Insulation
- * Digital Control Panel
- * Electrical Resistor Automatic Defrost
- * Stainless Steel Legs Adjustable for Height
- * Special Door and Hinge Systems
- * Removable and Easy Cleaning Magnetic Gasket
- * Ambient Temperature + 43 °C & % 65 Humidity
- * GN 1/3x150 Capacity Static Cooled Make-Up
- * Marble Top Front Work Top
- * Glass Cover over Make-Up

Kod Özellikleri / Available Codes

40x60 Tepsi Shelf Tray 56 €	W Tekerlekli Wheels 90 €
DZ Düz Üst Tabla Straight Work Top 0 €	A 10 cm Yuvarlatılmış Sırtlı Tabla 10 cm Curved Splashback Work Top 70 €
GR 2 Door 351 € 3 Door 461 €	MR 2 Door 271 € 3 Door 418 €
PL 2 Door 780 € 3 Door 1014 €	F 2 Door 109 € 3 Door 139 €
DKP 30 €	Touch Dijital Touch Digital 217 €
WP 137 €	60hz 56 €
BT 418 €	L 30 €
K 70 €/Unt	

Model Models	İç Sıcaklık Temperature °C	Brüt Hacim Gross volume Lt.	Ölçüler Dimensions Cm.	Paket Ölçüsü Packing Dim. Cm.	Ağırlık Weight Kg.	Paslanmaz Özelliği Stainless Steel Type
PPN2-DZ	-2/+8	380	155x80x85	165x90x100	159	304
	-2/+8	380	155x80x85	165x90x100	159	430
	-10/-22	380	155x80x85	165x90x100	159	304
	-10/-22	380	155x80x85	165x90x100	159	430
PPN3-DZ	-2/+8	615	210x80x85	220x90x100	260	304
	-2/+8	615	210x80x85	220x90x100	260	430
	-10/-22	615	210x80x85	220x90x100	260	304
	-10/-22	615	210x80x85	220x90x100	260	430

İzolasyon Kalınlığı Insulation Thickness	Raf Kızağı Takımı Shelf Rails Pair	Soğutma Gazı Cooling Gas	Voltaj Voltage	Enerji Sınıfı Energy Rating	Fiyat Price €	Model Models	Fiyat Price
50 mm	6 Shelf Rails	R134A	220 V / 50 Hz	D	3.094 €	PPN2-R290	3.066 €
50 mm	6 Shelf Rails	R134A	220 V / 50 Hz	D	2.702 €	BPN2-R290	2.675 €
50 mm	6 Shelf Rails	R404A	220 V / 50 Hz	E	3.751 €	PPL2-R290	3.723 €
50 mm	6 Shelf Rails	R404A	220 V / 50 Hz	E	3.548 €	BPL2-R290	3.521 €
50 mm	9 Shelf Rails	R134A	220 V / 50 Hz	D	3.740 €	PPN3-R290	3.712 €
50 mm	9 Shelf Rails	R134A	220 V / 50 Hz	D	3.124 €	BPN3-R290	3.098 €
50 mm	9 Shelf Rails	R404A	220 V / 50 Hz	E	4.402 €	PPL3-R290	4.374 €
50 mm	9 Shelf Rails	R404A	220 V / 50 Hz	E	3.857 €	BPL3-R290	3.830 €

EF: Bu modellerde energy efficiency kondenser fanı kullanılmaktadır. / These models have energy efficiency condenser fans.

Mayalama Buzdolabı

Retarder Prover Refrigerators



BL8-RP

28 Adet
40x60 cm Raf
Kapasitesi.
4,5 cm Aralıklı.
28 Unit
40x60 cm Shelf
Holder Capacity.
4,5 cm Spaced.

KF



89 €

Fanlı Kanopi
Canopy With Fan

▼ -20°C / +40°C ▲ r.h. 60-90%

Otomatik Su
Doldurma
Automatically
Water Filling



FRENOX
PROFESSIONAL REFRIGERATION

40x60 Line Series

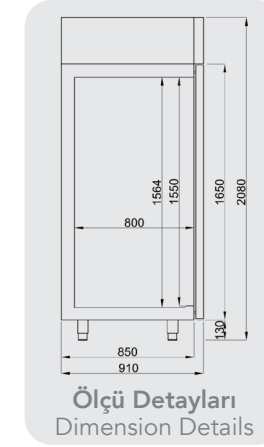

Ölçü Detayları
Dimension Details



Değiştirilebilen Arasında
Kir ve Bakteri Tutmayan
Yüksek Manyetik Çekimli
ÖZEL Conta
Special designed new gaskets.
Can be removed, dirt-free



Bilgi

- * İç Derinlik: 54 Adet
- * 35-40 Kg/m³ Gazlı Çevre Dostu HCFC İçermeyen Poliüretan İzolasyon
- * Otomatik Su Buharlaştırma Sistemi (Elektrik)
- * Yüksekliği Ayarlanabilir Paslanmaz Ayaklar
- * Kapı Açıldığında Otomatik İç Aydınlatma
- * Özel, Kapı Mentеше Sistemi
- * Temizlenebilir ve Sökülebilir Manyetik Kapı Contası
- * Dış Ortam Sıcaklığı: + 32°C & % 50 Nem
- * Dışardan Su Bağlantılı

Info

- * Inside Depth: 54 Units
- * 35-40 Kg/m³ Ecology Friendly HCFC Free Polyurethane Insulation
- * Automatic Water Evaporation System (Electrical)
- * Stainless Steel Legs Adjustable For Height
- * Automatic Lighting Inside When Door is Open
- * Special Hinges and Door System
- * Removable and Easy Cleaning Magnetic Gaskets
- * Ambient Temperature: + 32°C & % 50 Humidity
- * External Water Connection

Kod Özellikleri

Available Codes

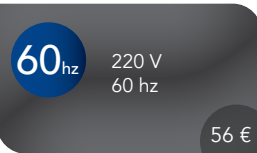

Model Models	İç Sıcaklık Temperature °C	Brüt Hacim Gross volume Lt.	Ölçüler Dimensions Cm.	Paket Ölçüsü Packing Dim. Cm.	Ağırlık Weight Kg.	Paslanmaz Özelliği Stainless Steel Type
 BL8-RP	-20/+40 r.h. %90-60	785	82x92x208	90x100x220	176	430

İzolasyon Kalınlığı Insulation Thickness	Raf Kızağı Adedi Shelf Unit	Soğutma Gazı Cooling Gas	Voltaj Voltage	Kapı Adedi Door Unit	Fiyat Price €	Model Models	Fiyat Price
60 mm	10	R404A	220 V / 50 Hz	1	8.716 €	BL8-RP-R290	8.660 €

Mayalama Buzdolabı

Retarder Prover Refrigerators



28 Adet
40x60 cm Raf
Kapasitesi.
4,5 cm Aralıklı.
28 Unit
40x60 cm Shelf
Holder Capacity.
4,5 cm Spaced.

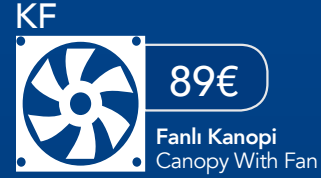

▼ -20°C / +40°C ▲ r.h. 60-90%

Otomatik Su
Doldurma
Automatically
Water Filling



PA-VL7-RO-RP

*Tepsi sürme arabası fiyata dahil değildir.
*Tray trolley is not included in the price.



FRENOX
PROFESSIONAL REFRIGERATION

40x60 Line Series

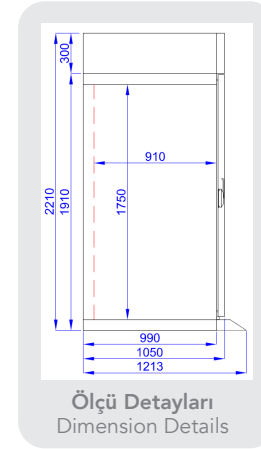

Ölçü Detayları
Dimension Details



Değiştirilebilen Arasında
Kir ve Bakteri Tutmayan
Yüksek Manyetik Çekimli
ÖZEL Conta
Special designed new gaskets.
Can be removed, dirt-free



Bilgi

- * İç Derinlik: 40x60 Tepsi Taşıma Arabası
- * Araba Yüksekliği Max. 145 Cm
- * 35-40 Kg/m³ Çevre Dostu HCFC İçermeyen Poliüretan İzolasyon
- * Dijital Kumanda Paneli
- * Kilitli Kapı
- * Otomatik Su Buharlaştırma Sistemi (Sıcak Gaz System)
- * Araba Sürmek İçin Özel Rampa
- * Özel Kapı ve Menteşe Sistemi
- * Temizlenebilir ve Sökülebilir Manyetik Kapı Contası
- * Dış Ortam Sıcaklığı + 43°C & % 65 Nem

Info

- * Inside Depth: 40x60 Tray Trolley
- * Trolley Height Max. 145 Cm.
- * 35-40 Kg/m³ Ecology Friendly HCFC Free Polyurethane Insulation
- * Digital Control Panel
- * Door Lock
- * Automatic Water Evaporation System (Hot Gas System)
- * Special bottom to enter with the Rolling Car
- * Special Door and Hinge Systems
- * Removable and Easy Cleaning Magnetic Gasket
- * Ambient Temperature + 43°C & % 65 Nem

Kod Özellikleri

Available Codes

Tepsi Taşıma Arabası
Tray Trolley
1.354 €

W
Tekerlekli / Wheels
90 €

60_{hz}
220 V
60 hz
56 €

Model Models	İç Sıcaklık Temperature °C	Brüt Hacim Gross volume Lt.	Ölçüler Dimensions Cm.	Paket Ölçüsü Packing Dim. Cm.	Ağırlık Weight Kg.	Paslanmaz Özelliği Stainless Steel Type
 PA-VL7-RO-RP	-20/+40 r.h. %90-60	700	91x121x221	100x130x240	250	304

İzolasyon Kalınlığı Insulation Thickness	Raf Adedi Shelf Unit	Soğutma Gazı Cooling Gas	Voltaj Voltage	Kapı Adedi Door Unit	Fiyat Price €	Model Models	Fiyat Price
80 mm	-	R404A	220 V / 50 Hz	1	10.899 €	PA-VL7-RO-RP-R290	10.842 €

256-257

Yatay Buzdolapları Make - Up
Counter Refrigerators Make - Up



Yatay Buzdolapları Make - Up
Counter Refrigerators Make - Up

258-259

260-261

Yatay Buzdolapları Make - Up
Counter Refrigerators Make - Up



Yükseltilmiş Make-Up Buzdolabı
High Make-Up Refrigerators

262-263

264-265

Yükseltilmiş Make Up Buzdolabı - Mermer Tablalı
High Make Up Refrigerator - Marble Top



Yatay Buzdolapları Make - Up
Counter Refrigerators Make - Up

266-267



Make-Up
Line Series

Yatay Buzdolapları Make - Up Counter Refrigerators Make - Up



Make - Up Line Series

Çekmece Seçenekleri / Drawer Options



- 3D** 1/3 Çekmece - 1/3 Drawers 597 €
- 2D** 1/2 Çekmece - 1/2 Drawers 551 €
- G** Cam Kapı - Glass Door 228 €
- 2/3D** 2/3 Çekmece - 2/3 Drawers 564 €

Cam Kapı Sadece Pozitif Kapılar İçindir
Glass Door Option is Only Available for Positive Doors

Bilgi

- * İç Derinlik: 43 Cm / 53 Cm (GN 1/1 Kapasiteli)
- * 35-40 Kg/m³ Çevre Dostu HCFC İçermeyen Poliüretan İzolasyon
- * Dijital Kumanda Paneli
- * Elektrik Rezistanslı Otomatik Defrost
- * Özel Su Buharlaştırma Sistemi
- * Yüksekliği Ayarlanabilir Paslanmaz Ayaklar
- * Özel, Kapı Mentеше Sistemi
- * Temizlenebilir ve Sökülebilir Manyetik Kapı Contası
- * Dış Ortam Sıcaklığı: + 43°C & % 65 Nem

Info

- * Inside Depth: 43 Cm / 53 Cm (GN 1/1 Capacity)
- * 35-40 Kg/m³ Ecology Friendly HCFC Free Polyurethane Insulation
- * Digital Control Panel
- * Electrical Resistor Automatic Defrost
- * Special Water Evaporation
- * Stainless Steel Legs Adjustable For Height
- * Special Door and Hinge Systems
- * Removable and Easy Cleaning Magnetic Gaskets
- * Ambient Temperature: + 43°C %65 Humidity

Option : 189 €



x2 Compressor
x2 Kompresör

115 V / 60 Hz

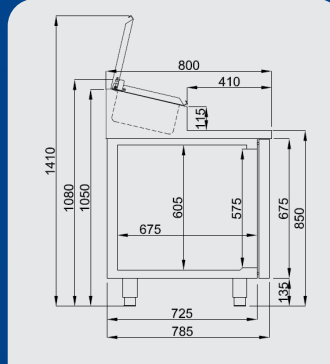

Ölçü Detayları
Dimension Details

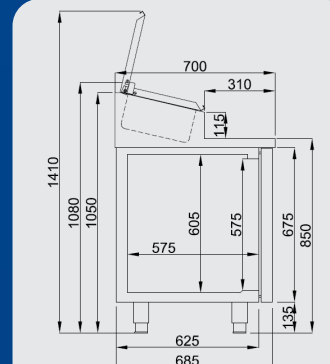

Ölçü Detayları
Dimension Details

GN 1/3x150

KF



153€

Fanlı Kanopi
Canopy With Fan

Gastronom kaplar fiyata dahil değildir.

Gastronom cups are not included in the price.

MGN3

Model Models	İç Sıcaklık Temperature °C	GN Kap GN Cup	Ölçüler Dimensions Cm.	Paket Ölçüsü Packing Dim. Cm.	Ağırlık Weight Kg.	Paslanmaz Özellik Type
	MGN2	-2/+8	7x1/3	140x70x109	150x80x125	155 304
	MPN2	-2/+8	7x1/3	140x80x109	150x90x125	170 304
	MGN3	-2/+8	10x1/3	186,5x70x109	197x80x125	185 304
	MPN3	-2/+8	10x1/3	186,5x80x109	197x90x125	200 304
	MGN4	-2/+8	12x1/3	233x70x109	243x80x125	205 304
	MPN4	-2/+8	12x1/3	233x80x109	243x90x125	220 304

İzolasyon Kalınlığı Insulation Thickness	Raf Adedi Shelf Unit	Soğutma Gazı Cooling Gas	Voltaj Voltage	Fiyat Price €	Model Models	Fiyat Price
50 mm	2	R134A	220 V / 50 Hz	3.023 €	MGN2-R290	2.996 €
50 mm	2	R134A	220 V / 50 Hz	3.386 €	MPN2-R290	3.359 €
50 mm	3	R134A	220 V / 50 Hz	3.497 €	MGN3-R290	3.470 €
50 mm	3	R134A	220 V / 50 Hz	3.926 €	MPN3-R290	3.899 €
50 mm	4	R134A	220 V / 50 Hz	4.383 €	MGN4-R290	4.355 €
50 mm	4	R134A	220 V / 50 Hz	5.048 €	MPN4-R290	5.021 €

Kod Özellikleri Available Codes

Raf ve Raf Kızağı Shelf and Shelf Holder 49 €

GR 2 Door 678 €
3 Door 811 €
4 Door 949 €

Granit Üst Tabla Granite Work Top

W 90 €

Tekerlekli Wheels

MR 2 Door 418 €
3 Door 543 €
4 Door 745 €

Mermer Üst Tabla Marble Work Top

PL 2 Door 610 €
3 Door 745 €
4 Door 882 €

Polietilen Üst Tabla Polyethylene Work Top

T x2 217 €

Touch Dijital Touch Digital

DKP x2 30 €

Dijital Koruma Plastiği Digital Cover

60hz 56 €

220 V 60 Hz

WP x2 137 €

Su Geçirmez Dijital Water Proof Digital

BT x2 418 €

Wi-Fi Dijital Wi-Fi Digital

K 70 €/Unt

Kilitli Kapı With Lock

256

257

Yatay Buzdolapları Make - Up Counter Refrigerators Make - Up



Make - Up Line Series



x2 Compressor
x2 Kompresör

Option : 189 €

115 V / 60 Hz

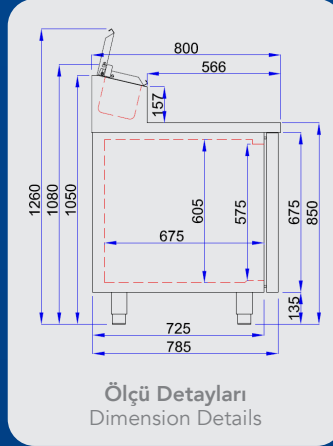

Ölçü Detayları
Dimension Details

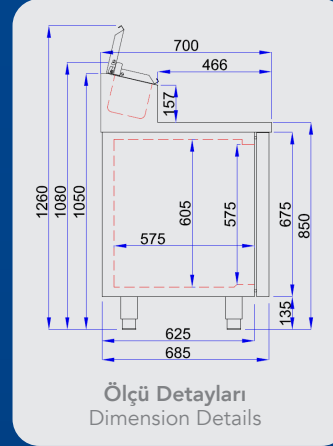

Ölçü Detayları
Dimension Details



GN 1/6x150

KF



153€

Fanlı Kanopi
Canopy With Fan

Gastronom kaplar fiyata dahil değildir.

Gastronom cups are not included in the price.

Çekmece Seçenekleri / Drawer Options

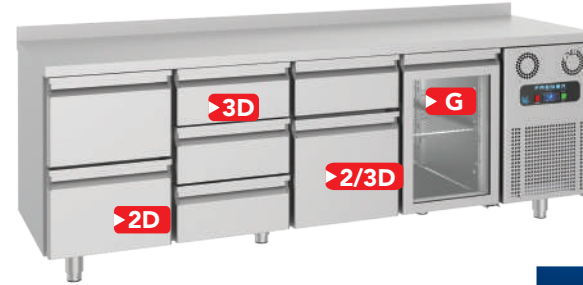

3D 1/3 Çekmece - 1/3 Drawers 597 €

2D 1/2 Çekmece - 1/2 Drawers 551 €

G Cam Kapı - Glass Door 228 €

2/3D 2/3 Çekmece - 2/3 Drawers 564 €

Cam Kapı Sadece Pozitif Kapılar İçindir
Glass Door Option is Only Available for Positive Doors

Bilgi

- * İç Derinlik: 43 Cm / 53 Cm (GN 1/1 Kapasiteli)
- * 35-40 Kg/m³ Çevre Dostu HCFC İçermeyen Poliüretan İzolasyon
- * Dijital Kumanda Paneli
- * Elektrik Rezistanslı Otomatik Defrost
- * Özel Su Buharlaştırma Sistemi
- * Yüksekliği Ayarlanabilir Paslanmaz Ayaklar
- * Özel, Kapı Mentеше Sistemi
- * Temizlenebilir ve Sökülebilir Manyetik Kapı Contası
- * Dış Ortam Sıcaklığı: + 43°C & % 65 Nem

Info

- * Inside Depth: 43 Cm / 53 Cm (GN 1/1 Capacity)
- * 35-40 Kg/m³ Ecology Friendly HCFC Free Polyurethane Insulation
- * Digital Control Panel
- * Electrical Resistor Automatic Defrost
- * Special Water Evaporation
- * Stainless Steel Legs Adjustable For Height
- * Special Door and Hinge Systems
- * Removable and Easy Cleaning Magnetic Gaskets
- * Ambient Temperature: + 43°C %65 Humidity

Kod Özellikleri Available Codes

Raf ve Raf Kızağı Shelf and Shelf Holder 49 €

W Tekerlekli Wheels 90 €

GR 2 Door 678 €
3 Door 811 €
4 Door 949 €

MR 2 Door 418 €
3 Door 543 €
4 Door 745 €

Granit Üst Tabla Granite Work Top

Mermer Üst Tabla Marble Work Top

PL 2 Door 610 €
3 Door 745 €
4 Door 882 €

T x2 217 €

Poliütilen Üst Tabla Polyethylene Work Top

Touch Dijital Touch Digital

DKP x2 30 €

60hz 56 €

Dijital Koruma Plastiği Digital Cover

220 V
60 Hz

WP x2 137 €

BT x2 418 €

Su Geçirmez Dijital Water Proof Digital

Wi-Fi Dijital Wi-Fi Digital

K 70 €/Unt

Kilitli Kapı With Lock

MGN3-06

Model Models	İç Sıcaklık Temperature °C	GN Kap GN Cup	Ölçüler Dimensions Cm.	Paket Ölçüsü Packing Dim. Cm.	Ağırlık Weight Kg.	Paslanmaz Özelligi Stainless Steel Type
MGN2-06	-2/+8	7x1/6	140x70x109	150x80x125	155	304
MPN2-06	-2/+8	7x1/6	140x80x109	150x90x125	170	304
MGN3-06	-2/+8	10x1/6	186,5x70x109	197x80x125	185	304
MPN3-06	-2/+8	10x1/6	186,5x80x109	197x90x125	200	304
MGN4-06	-2/+8	12x1/6	233x70x109	243x80x125	205	304
MPN4-06	-2/+8	12x1/6	233x80x109	243x90x125	220	304

İzolasyon Kalınlığı Insulation Thickness	Raf Adedi Shelf Unit	Soğutma Gazı Cooling Gas	Voltaj Voltage	Fiyat Price €	Model Models	Fiyat Price
50 mm	2	R134A	220 V / 50 Hz	3.023 €	MGN2-06-R290	2.996 €
50 mm	2	R134A	220 V / 50 Hz	3.386 €	MPN2-06-R290	3.359 €
50 mm	3	R134A	220 V / 50 Hz	3.497 €	MGN3-06-R290	3.470 €
50 mm	3	R134A	220 V / 50 Hz	3.926 €	MPN3-06-R290	3.899 €
50 mm	4	R134A	220 V / 50 Hz	4.383 €	MGN4-06-R290	4.355 €
50 mm	4	R134A	220 V / 50 Hz	5.048 €	MPN4-06-R290	5.021 €

Yatay Buzdolapları Make - Up Counter Refrigerators Make - Up

Option : 189 €



115 V / 60 Hz

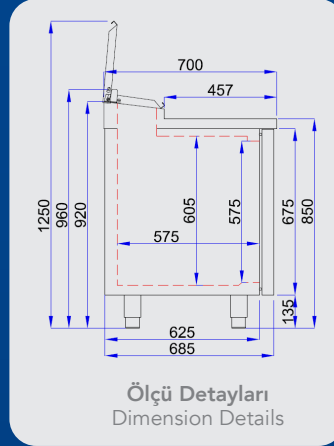

Ölçü Detayları
Dimension Details

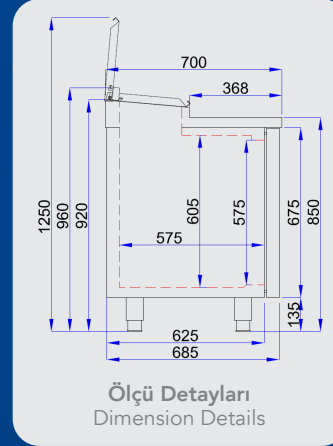

Ölçü Detayları
Dimension Details



MGA3-04

GN 1/4x150
GN 1/6x150

KF



153€

Fanlı Kanopi
Canopy With Fan

Gastronom kaplar fiyata dahil değildir.

Gastronom cups are not included in the price.



FRENOX
PROFESSIONAL REFRIGERATION

Make - Up Line Series

Çekmece Seçenekleri / Drawer Options

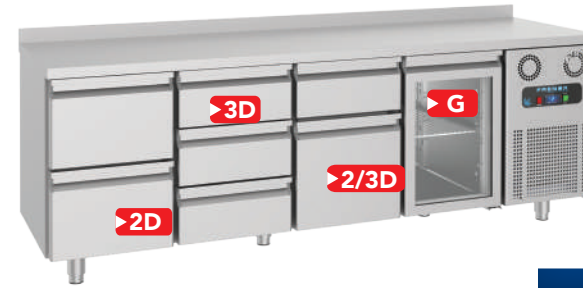

- 3D** 1/3 Çekmece - 1/3 Drawers 597 €
- 2D** 1/2 Çekmece - 1/2 Drawers 551 €
- G** Cam Kapı - Glass Door 228 €
- 2/3D** 2/3 Çekmece - 2/3 Drawers 564 €

Cam Kapı Sadece Pozitif Kapılar İçindir
Glass Door Option is Only Available for Positive Doors

Bilgi

- * İç Derinlik: 43 Cm / 53 Cm (GN 1/1 Kapasiteli)
- * 35-40 Kg/m³ Çevre Dostu HCFC İçermeyen Poliüretan İzolasyon
- * Dijital Kumanda Paneli
- * Elektrik Rezistanslı Otomatik Defrost
- * Özel Su Buharlaştırma Sistemi
- * Yüksekliği Ayarlanabilir Paslanmaz Ayaklar
- * Özel, Kapı Mentеше Sistemi
- * Temizlenebilir ve Sökülebilir Manyetik Kapı Contası
- * Dış Ortam Sıcaklığı: + 43°C & % 65 Nem

Info

- * Inside Depth: 43 Cm / 53 Cm (GN 1/1 Capacity)
- * 35-40 Kg/m³ Ecology Friendly HCFC Free Polyurethane Insulation
- * Digital Control Panel
- * Electrical Resistor Automatic Defrost
- * Special Water Evaporation
- * Stainless Steel Legs Adjustable For Height
- * Special Door and Hinge Systems
- * Removable and Easy Cleaning Magnetic Gaskets
- * Ambient Temperature: + 43°C %65 Humidity

Kod Özellikleri Available Codes

Raf ve Raf Kızağı Shelf and Shelf Holder 49 €

MR 2 Door 418 €
3 Door 543 €
4 Door 745 €

Mermer Üst Tabla Marble Work Top

WP 137 €

Su Geçirmez Dijital Water Proof Digital

GR 2 Door 678 €
3 Door 811 €
4 Door 949 €

Granit Üst Tabla Granite Work Top

PL 2 Door 610 €
3 Door 745 €
4 Door 882 €

Polyetilen Üst Tabla Polyethylene Work Top

T 217 €

Touch Dijital Touch Digital

DKP 30 €

Dijital Koruma Plastiği Digital Cover

60hz 56 €

220 V
60 Hz

BT 418 €

Wi-Fi Dijital Wi-Fi Digital

W 90 €

Tekerlekli Wheels

K 70 €/Unt

Kilitli Kapı With Lock

Model Models	İç Sıcaklık Temperature °C	GN Kap GN Cup	Ölçüler Dimensions Cm.	Paket Ölçüsü Packing Dim. Cm.	Ağırlık Weight Kg.	Paslanmaz Özelliği Stainless Steel Type	
	MGA2-04	-2/+8	8	140x70x97	150x80x113	145	304
	MGA2-06	-2/+8	8	140x70x97	150x80x113	140	304
	MGA3-04	-2/+8	11	186,5x70x97	197x80x113	170	304
	MGA3-06	-2/+8	11	186,5x70x97	197x80x113	165	304
	MGA4-04	-2/+8	13	233x70x97	247x80x113	200	304
	MGA4-06	-2/+8	13	233x70x97	247x80x113	195	304

İzolasyon Kalınlığı Insulation Thickness	Raf Adedi Shelf Unit	Soğutma Gazı Cooling Gas	Voltaj Voltage	Fiyat Price €	Model Models	Fiyat Price
50 mm	2	R134A	220 V / 50 Hz	3.002 €	MGA2-04-R290	2.978 €
50 mm	2	R134A	220 V / 50 Hz	3.076 €	MGA2-06-R290	3.051 €
50 mm	4	R134A	220 V / 50 Hz	3.440 €	MGA3-04-R290	3.414 €
50 mm	4	R134A	220 V / 50 Hz	3.519 €	MGA3-06-R290	3.494 €
50 mm	6	R134A	220 V / 50 Hz	4.406 €	MGA4-04-R290	4.381 €
50 mm	6	R134A	220 V / 50 Hz	4.553 €	MGA4-06-R290	4.529 €

Yükseltilmiş Make-Up Buzdolabı

High Make-Up Refrigerators



Make - Up Line Series

Çekmece Seçenekleri / Drawer Options



- 3D** 1/3 Çekmece - 1/3 Drawers 597 €
- 2D** 1/2 Çekmece - 1/2 Drawers 551 €
- G** Cam Kapı - Glass Door 228 €
- 2/3D** 2/3 Çekmece - 2/3 Drawers 564 €

Cam Kapı Sadece Pozitif Kapılar İçindir
Glass Door Option is Only Available for Positive Doors

Bilgi

- * İç Derinlik: 43 Cm / 53 Cm (GN 1/1 Kapasiteli)
- * 35-40 Kg/m³ Çevre Dostu HCFC İçermeyen Poliüretan İzolasyon
- * Dijital Kumanda Paneli
- * Elektrik Rezistanslı Otomatik Defrost
- * Özel Su Buharlaştırma Sistemi
- * Yüksekliği Ayarlanabilir Paslanmaz Ayaklar
- * Özel, Kapı Mentеше Sistemi
- * Temizlenebilir ve Sökülebilir Manyetik Kapı Contası
- * Dış Ortam Sıcaklığı: + 43°C & % 65 Nem

Info

- * Inside Depth: 43 Cm / 53 Cm (GN 1/1 Capacity)
- * 35-40 Kg/m³ Ecology Friendly HCFC Free Polyurethane Insulation
- * Digital Control Panel
- * Electrical Resistor Automatic Defrost
- * Special Water Evaporation
- * Stainless Steel Legs Adjustable For Height
- * Special Door and Hinge Systems
- * Removable and Easy Cleaning Magnetic Gaskets
- * Ambient Temperature: + 43°C %65 Humidity

Option : 189 €

115 V / 60 Hz

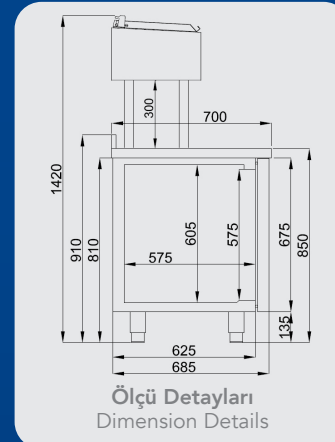

Ölçü Detayları
Dimension Details



x2 Compressor
x2 Kompresör

KF





153€

Fanlı Kanopi
Canopy With Fan

Gastronom kaplar fiyata dahil değildir.

Gastronom cups are not included in the price.

CGN2-YM

Model Models	İç Sıcaklık Temperature °C	GN Kap GN Cup	Ölçüler Dimensions Cm.	Paket Ölçüsü Packing Dim. Cm.	Ağırlık Weight Kg.	Paslanmaz Özellikler Stainless Steel Type
 CGN2-YM	-2/+8	7	140x70x142	150x80x158	150	304
 CGN3-YM	-2/+8	10	186,5x70x142	197x80x158	185	304
 CGN4-YM	-2/+8	12	233x70x142	243x80x158	200	304

İzolasyon Kalınlığı Insulation Thickness	Raf Adedi Shelf Unit	Soğutma Gazı Cooling Gas	Voltaj Voltage	Fiyat Price €	Model Models	Fiyat Price
50 mm	2	R134A	220 V / 50 Hz	3.262 €	CGN2-YM-R290	3.237 €
50 mm	3	R134A	220 V / 50 Hz	4.033 €	CGN3-YM-R290	4.008 €
50 mm	4	R134A	220 V / 50 Hz	4.845 €	CGN4-YM-R290	4.820 €

Kod Özellikleri Available Codes

Raf ve Raf Kızağı Shelf and Shelf Holder 49 €

DZ 0 €
Düz Üst Tabla Straight Work Top

DKP x2 30 €
Dijital Koruma Plastiği Digital Cover

WP x2 137 €
Su Geçirmez Dijital Water Proof Digital

BT x2 418 €
Wi-Fi Dijital Wi-Fi Digital

W 90 €
Tekerlekli Wheels

K 70 €/Unt
Kilitli Kapı With Lock

T x2 217 €
Touch Dijital Touch Digital

60hz 56 €
220 V 60 hz

Yükseltilmiş Make Up Buzdolabı - Mermer Tablalı

High Make Up Refrigerator - Marble Top



Make - Up Line Series

Çekmece Seçenekleri / Drawer Options



Cam Kapı Sadece Pozitif Kapılar İçindir
Glass Door Option is Only Available for Positive Doors

Kod Özellikleri / Available Codes

- K** 70 €/Unt. Kilitli Kapı With Lock
- Raf ve Raf Kızağı** Shelf and Shelf Holder 49 €
- DKP** x2 30 € Dijital Koruma Plastiği Digital Cover
- T** x2 217 € Touch Dijital Touch Digital
- WP** x2 137 € Su Geçirmez Dijital Water Proof Digital
- 60_{hz}** 56 € 220 V 60 hz
- BT** x2 418 € Wi-Fi Dijital Wi-Fi Digital
- W** 90 € Tekerlekli Wheels

Bilgi

- * İç Derinlik: 43 Cm / 53 Cm (GN 1/1 Kapasiteli)
- * 35-40 Kg/m³ Çevre Dostu HCFC İçermeyen Poliüretan İzolasyon
- * Dijital Kumanda Paneli
- * Elektrik Rezistanslı Otomatik Defrost
- * Özel Su Buharlaştırma Sistemi
- * Yüksekliği Ayarlanabilir Paslanmaz Ayaklar
- * Özel, Kapı Mentеше Sistemi
- * Temizlenebilir ve Sökülebilir Manyetik Kapı Contası
- * Dış Ortam Sıcaklığı: + 43°C & % 65 Nem

Info

- * Inside Depth: 43 Cm / 53 Cm (GN 1/1 Capacity)
- * 35-40 Kg/m³ Ecology Friendly HCFC Free Polyurethane Insulation
- * Digital Control Panel
- * Electrical Resistor Automatic Defrost
- * Special Water Evaporation
- * Stainless Steel Legs Adjustable For Height
- * Special Door and Hinge Systems
- * Removable and Easy Cleaning Magnetic Gaskets
- * Ambient Temperature: + 43°C %65 Humidity

x2 Compressor
x2 Kompresör

Option : 189 €

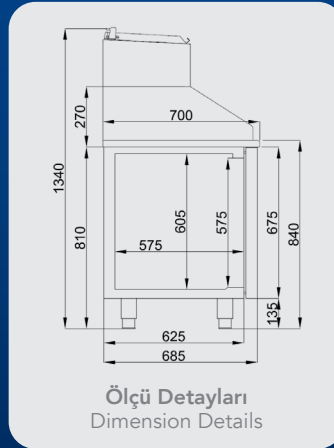

115 V / 60 Hz



KF
153€
Fanlı Kanopi
Canopy With Fan

Gastronom kaplar fiyata dahil değildir.
Gastronom cups are not included in the price.

CGN3-YM-MR

Model Models	İç Sıcaklık Temperature °C	GN Kap GN Cup	Ölçüler Dimensions Cm.	Paket Ölçüsü Packing Dim. Cm.	Ağırlık Weight Kg.	Paslanmaz Özelliği Stainless Steel Type
 CGN2-YM-MR	-2/+8	7	140x70x134	150x80x150	190	304
 CGN3-YM-MR	-2/+8	10	186,5x70x134	197x80x150	230	304
 CGN4-YM-MR	-2/+8	12	233x70x134	243x80x150	280	304

İzolasyon Kalınlığı Insulation Thickness	Raf Adedi Shelf Unit	Soğutma Gazı Cooling Gas	Voltaj Voltage	Fiyat Price €	Model Models	Fiyat Price
50 mm	2	R134A	220 V / 50 Hz	3.741 €	CGN2-YM-MR-R290	3.717 €
50 mm	3	R134A	220 V / 50 Hz	4.480 €	CGN3-YM-MR-R290	4.455 €
50 mm	4	R134A	220 V / 50 Hz	5.515 €	CGN4-YM-MR-R290	5.488 €

Yatay Buzdolapları Make - Up Counter Refrigerators Make - Up



x2 Compressor
x2 Kompresör

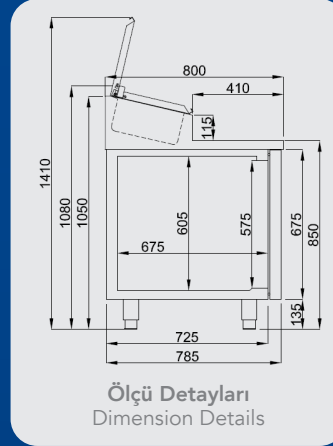

Option : 189 €

115 V / 60 Hz

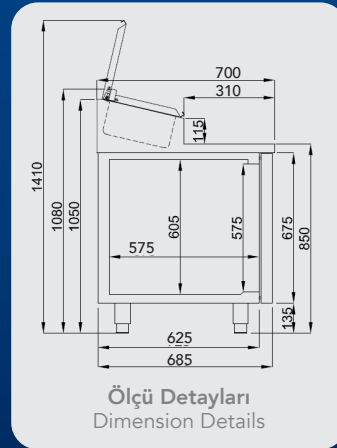

KF



153€

Fanlı Kanopi
Canopy With Fan

Gastronom kaplar fiyata dahil değildir.
Gastronom cups are not included in the price.

MPN3-7G



Make - Up Line Series

Çekmece Seçenekleri / Drawer Options

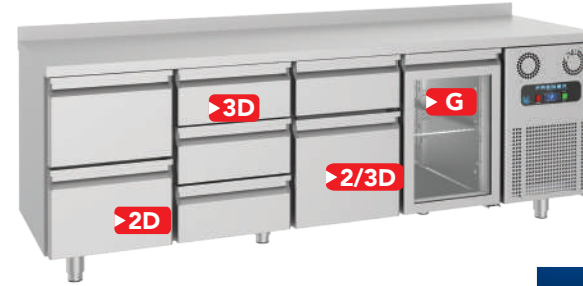

- 3D** 1/3 Çekmece - 1/3 Drawers 597 €
- 2D** 1/2 Çekmece - 1/2 Drawers 551 €
- G** Cam Kapı - Glass Door 228 €
- 2/3D** 2/3 Çekmece - 2/3 Drawers 564 €

Cam Kapı Sadece Pozitif Kapılar İçindir
Glass Door Option is Only Available for Positive Doors

Bilgi

- * İç Derinlik: 43 Cm / 53 Cm (GN 1/1 Kapasiteli)
- * 35-40 Kg/m³ Çevre Dostu HCFC İçermeyen Poliüretan İzolasyon
- * Dijital Kumanda Paneli
- * Elektrik Rezistanslı Otomatik Defrost
- * Özel Su Buharlaştırma Sistemi
- * Yüksekliği Ayarlanabilir Paslanmaz Ayaklar
- * Özel, Kapı Mentеше Sistemi
- * Temizlenebilir ve Sökülebilir Manyetik Kapı Contası
- * Dış Ortam Sıcaklığı: + 43°C & % 65 Nem

Info

- * Inside Depth: 43 Cm / 53 Cm (GN 1/1 Capacity)
- * 35-40 Kg/m³ Ecology Friendly HCFC Free Polyurethane Insulation
- * Digital Control Panel
- * Electrical Resistor Automatic Defrost
- * Special Water Evaporation
- * Stainless Steel Legs Adjustable For Height
- * Special Door and Hinge Systems
- * Removable and Easy Cleaning Magnetic Gaskets
- * Ambient Temperature: + 43°C %65 Humidity

Kod Özellikleri Available Codes

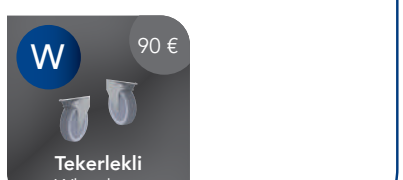
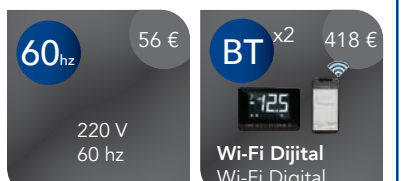
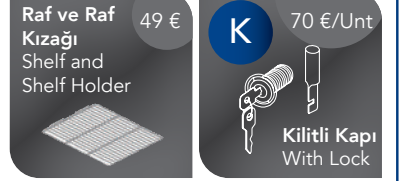

Model Models	İç Sıcaklık Temperature °C	GN Kap GN Cup 1/3x150	Ölçüler Dimensions Cm.	Paket Ölçüsü Packing Dim. Cm.	Ağırlık Weight Kg.	Paslanmaz Özellikler Stainless Steel Type
MGN2-4G	-2/+8	4	140x70x109	150x80x125	140	304
MPN2-4G	-2/+8	4	140x80x109	150x80x125	160	304
MGN3-7G	-2/+8	7	186,5x70x109	196x80x125	150	304
MPN3-7G	-2/+8	7	186,5x80x109	196x80x125	170	304
MGN4-9G	-2/+8	9	233x70x109	243x80x125	170	304
MPN4-9D	-2/+8	9	233x80x109	243x80x125	190	304

İzolasyon Kalınlığı Insulation Thickness	Raf Adedi Shelf Unit	Soğutma Gazı Cooling Gas	Voltaj Voltage	Fiyat Price €	Model Models	Fiyat Price
50 mm	2	R134A	220 V / 50 Hz	3.239 €	MGN2-4G-R290	3.211 €
50 mm	2	R134A	220 V / 50 Hz	3.704 €	MPN2-4G-R290	3.676 €
50 mm	3	R134A	220 V / 50 Hz	3.755 €	MGN3-7G-R290	3.728 €
50 mm	3	R134A	220 V / 50 Hz	4.294 €	MPN3-7G-R290	4.268 €
50 mm	4	R134A	220 V / 50 Hz	4.827 €	MGN4-9G-R290	4.799 €
50 mm	4	R134A	220 V / 50 Hz	5.559 €	MPN4-9D-R290	5.531 €



Yatay Servis Buzdolapları / Suşi Üniteleri
Counter Service Refrigerators / Sushi Units

270-271

272-273

Yatay Buzdolaplar Servis Serisi/Açık Havuzlu
Counter Refrigerators Service Series/Open Pool



Yatay Buzdolaplar Servis Serisi/Statik Soğuk Havuzlu
Counter Refrigerators Service Series/Static Cold Pool

274-275

276-277

Yatay Buzdolaplar Servis Serisi/Camlı
Counter Refrigerators Service Series/With Glass



Yatay Buzdolaplar Servis Serisi
Counter Refrigerators Service Series

278-279



Yatay Servis Buzdolapları / Sushi Ünitesi

Counter Service Refrigerators / Sushi Unit



Service Line Series

Çekmece Seçenekleri / Drawer Options



100 h. GN Kap : Üst Çekmece 1/3 Kazan
150 h. GN Kap : Üst Çekmece Çalışmaz
100 h. GN Cup : Upper Drawer 1/3 Case
150 h. GN Cup : Upper Drawer Will not Work

Cam Kapı Sadece Pozitif Kapılar İçindir
Glass Door Option is Only Available for Positive Doors

Ekstra Statik Soğutma
Monoblock Cooling Group

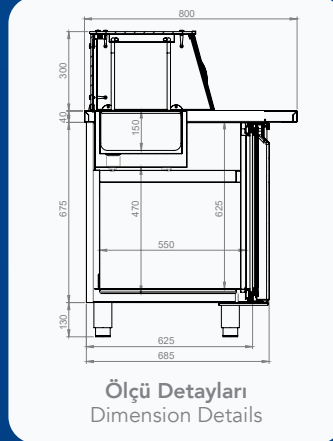

Option : 189 €

115 V / 60 Hz

Bilgi

- * İç Derinlik: 43 Cm / 53 Cm (GN 1/1 Kapasiteli)
- * 35-40 Kg/m³ Çevre Dostu HCFC İçermeyen Poliüretan İzolasyon
- * Dijital Kumanda Paneli
- * Elektrik Rezistanslı Otomatik Defrost
- * Yüksekliği Ayarlanabilir Paslanmaz Ayaklar
- * Özel, Kapı Menteşe Sistemi
- * Temizlenebilir ve Sökülebilir Manyetik Kapı Contası
- * Dış Ortam Sıcaklığı: + 43 °C & % 65 Nem
- * Işıklı Cam Bölüm
- * Pleksi Sürgü Kapak
- * Üst camlı bölümde ekstra statik soğutma

Info

- * Inside Depth: 43 Cm / 53 Cm (GN 1/1 Capacity)
- * 35-40 Kg/m³ Ecology Friendly HCFC Free Polyurethane Insulation
- * Digital Control Panel
- * Electrical Resistor Automatic Defrost
- * Stainless Steel Legs Adjustable For Height
- * Special Door and Hinge Systems
- * Removable and Easy Cleaning Magnetic Gaskets
- * Ambient Temperature: + 43 °C %65 Humidity
- * Glass Cover with LED Light
- * Plexiglas Sliding Cover
- * Extra static cooling in the upper glass section

Kod Özellikleri

Available Codes



SHS3

Model Models	İç Sıcaklık Temperature °C	Brüt Hacim Gross volume Lt. GN1/3x150	Ölçüler Dimensions Cm.	Paket Ölçüsü Packing Dim. Cm.	Ağırlık Weight Kg.	Paslanmaz Özelliği Stainless Steel Type
	-2/+8	7	140X80X85	150X86X100	150	304
	-2/+8	9	186,5X80X85	197X86X100	180	304
	-2/+8	12	233X80X85	243X86X100	200	304

İzolasyon Kalınlığı Insulation Thickness	Raf Adedi Shelf Unit	Soğutma Gazı Cooling Gas	Voltaj Voltage	Fiyat Price €
50mm	2	R134A	220V/50Hz	3.856 €
50mm	3	R134A	220V/50Hz	4.631 €
50mm	4	R134A	220V/50Hz	5.888 €

Model Models	Fiyat Price
SHS2-R290	3.750 €
SHS3-R290	4.525 €
SHS4-R290	5.782 €

Yatay Buzdolaplar Servis Serisi/Açık Havuzlu Counter Refrigerators Service Series/Open Pool

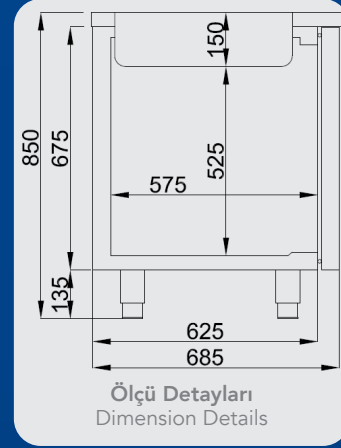

Option : 189 €

115 V / 60 Hz



CGN3-SG

Gastronom kaplar fiyata dahil değildir.

Gastronom cups are not included in the price.



Service Line Series

Çekmece Seçenekleri / Drawer Options



- 3D** 1/3 Çekmece - 1/3 Drawers 597 €
- 2D** 1/2 Çekmece - 1/2 Drawers 469 €
- G** Cam Kapı - Glass Door 228 €
- 2/3D** 2/3 Çekmece - 2/3 Drawers 564 €

100 h. GN Kap : Üst Çekmece 1/3 Kazan
150 h. GN Kap : Üst Çekmece Çalışmaz
100 h. GN Cup : Upper Drawer 1/3 Case
150 h. GN Cup : Upper Drawer Will not Work

Cam Kapı Sadece Pozitif Kapılar İçindir
Glass Door Option is Only Available for Positive Doors

Bilgi

- * İç Derinlik: 43 Cm / 53 Cm (GN 1/1 Kapasiteli)
- * 35-40 Kg/m³ Çevre Dostu HCFC İçermeyen Poliüretan İzolasyon
- * Dijital Kumanda Paneli
- * Elektrik Rezistanslı Otomatik Defrost
- * Özel Su Buharlaştırma Sistemi
- * Yüksekliği Ayarlanabilir Paslanmaz Ayaklar
- * Özel, Kapı Menteşe Sistemi
- * Temizlenebilir ve Sökülebilir Manyetik Kapı Contası
- * Dış Ortam Sıcaklığı: + 43°C & % 65 Nem

Info

- * Inside Depth: 43 Cm / 53 Cm (GN 1/1 Capacity)
- * 35-40 Kg/m³ Ecology Friendly HCFC Free Polyurethane Insulation
- * Digital Control Panel
- * Electrical Resistor Automatic Defrost
- * Special Water Evaporation
- * Stainless Steel Legs Adjustable For Height
- * Special Door and Hinge Systems
- * Removable and Easy Cleaning Magnetic Gaskets
- * Ambient Temperature: + 43°C %65 Humidity

Kod Özellikleri Available Codes

Raf ve Raf Kızağı Shelf and Shelf Holder 49 €

W Tekerlekli Wheels 90 €

DKP Dijital Koruma Plastiği Digital Cover 30 €





T Touch Dijital Touch Digital 217 €

WP Su Geçirmez Dijital Water Proof Digital 137 €

60hz 220 V 60 hz 56 €

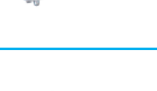
K Kilitli Kapı With Lock 70 €/Unt

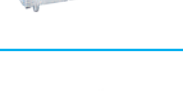
BT Wi-Fi Dijital Wi-Fi Digital 418 €

Model Models	İç Sıcaklık Temperature °C	Brüt Hacim Gross volume Lt. GN-1/1x150	Ölçüler Dimensions Cm.	Paket Ölçüsü Packing Dim. Cm.	Ağırlık Weight Kg.	Paslanmaz Özelliği Stainless Steel Type
 CGN2-SG	-2/+8	4	140x70x85	150x80x100	130	304
 BGN2-SG	-2/+8	4	140x70x85	150x80x100	130	430
 CGN3-SG	-2/+8	5	186,5x70x85	197x80x100	160	304
 BGN3-SG	-2/+8	5	186,5x70x85	197x80x100	160	430
 CGN4-SG	-2/+8	6	233x70x85	243x80x100	180	304
 BGN4-SG	-2/+8	6	233x70x85	243x80x100	180	430

İzolasyon Kalınlığı Insulation Thickness	Raf Adedi Shelf Unit	Soğutma Gazı Cooling Gas	Voltaj Voltage	Fiyat Price €	Model Models	Fiyat Price
50 mm	2	R134A	220 V / 50 Hz	2.842 €	CGN2-SG-R290	2.815 €
50 mm	2	R134A	220 V / 50 Hz	2.555 €	BGN2-SG-R290	2.529 €
50 mm	3	R134A	220 V / 50 Hz	3.451 €	CGN3-SG-R290	3.424 €
50 mm	3	R134A	220 V / 50 Hz	2.956 €	BGN3-SG-R290	2.930 €
50 mm	4	R134A	220 V / 50 Hz	4.062 €	CGN4-SG-R290	4.034 €
50 mm	4	R134A	220 V / 50 Hz	3.545 €	BGN4-SG-R290	3.519 €

Yatay Buzdolaplar Servis Serisi / Statik Soğuk Havuzlu Counter Refrigerators Service Series / Static Cold Pool

GN Kap Havuzu
Tamamen Kapalı
ve Statik Olarak
Soğutulmaktadır
GN Cup Cold Pool
is Closed and Have
Static Cooling

Option : 189 €

115 V / 60 Hz

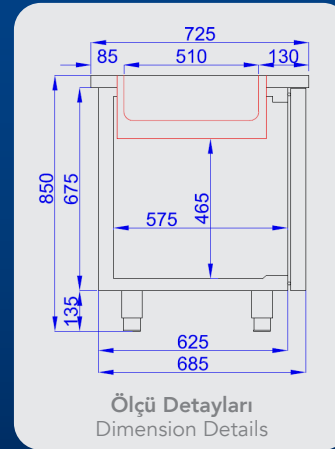

Gastronom kaplar fiyata dahil değildir.
Gastronom cups are not included in the price.

CGN3-SG-CL



FRENOX
PROFESSIONAL REFRIGERATION

Service Line Series

Çekmece Seçenekleri / Drawer Options



100 h. GN Kap : Üst Çekmece 1/3 Kazan
150 h. GN Kap : Üst Çekmece Çalışmaz
100 h. GN Cup : Upper Drawer 1/3 Case
150 h. GN Cup : Upper Drawer Will not Work

Cam Kapı Sadece Pozitif Kapılar İçindir
Glass Door Option is Only Available for Positive Doors

Bilgi

- * İç Derinlik: 43 Cm / 53 Cm (GN 1/1 Kapasiteli)
- * 35-40 Kg/m³ Çevre Dostu HCFC İçermeyen Poliüretan İzolasyon
- * Dijital Kumanda Paneli
- * Elektrik Rezistanslı Otomatik Defrost
- * Özel Su Buharlaştırma Sistemi
- * Yüksekliği Ayarlanabilir Paslanmaz Ayaklar
- * Özel, Kapı Mentеше Sistemi
- * Temizlenebilir ve Sökülebilir Manyetik Kapı Contası
- * Dış Ortam Sıcaklığı: + 43°C & % 65 Nem

Info

- * Inside Depth: 43 Cm / 53 Cm (GN 1/1 Capacity)
- * 35-40 Kg/m³ Ecology Friendly HCFC Free Polyurethane Insulation
- * Digital Control Panel
- * Electrical Resistor Automatic Defrost
- * Special Water Evaporation
- * Stainless Steel Legs Adjustable For Height
- * Special Door and Hinge Systems
- * Removable and Easy Cleaning Magnetic Gaskets
- * Ambient Temperature: + 43°C %65 Humidity

Kod Özellikleri Available Codes

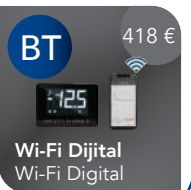
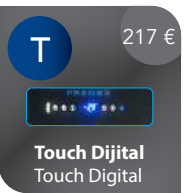
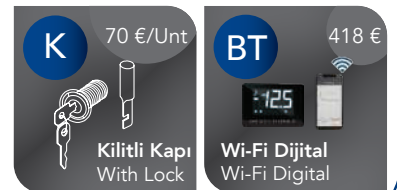
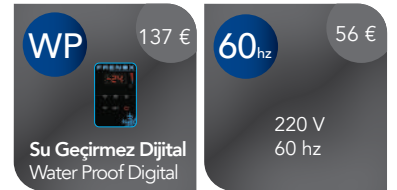

Model Models	İç Sıcaklık Temperature °C	Brüt Hacim Gross volume Lt. GN-1/1x150	Ölçüler Dimensions Cm.	Paket Ölçüsü Packing Dim. Cm.	Ağırlık Weight Kg.	Paslanmaz Özellikler Stainless Steel Type
 CGN2-SG-CL	-2/+8	4	140x72,5x85	150x80x100	150	304
 BGN2-SG-CL	-2/+8	4	140x72,5x85	150x80x100	150	430
 CGN3-SG-CL	-2/+8	5	186,5x72,5x85	197x80x100	180	304
 BGN3-SG-CL	-2/+8	5	186,5x72,5x85	197x80x100	180	430
CGN4-SG-CL	-2/+8	6	233x72,5x85	243x80x100	200	304
BGN4-SG-CL	-2/+8	6	233x72,5x85	243x80x100	200	430

İzolasyon Kalınlığı Insulation Thickness	Raf Adedi Shelf Unit	Soğutma Gazı Cooling Gas	Voltaj Voltage	Fiyat Price €
50 mm	2	R134A	220 V / 50 Hz	3.589 €
50 mm	2	R134A	220 V / 50 Hz	3.116 €
50 mm	3	R134A	220 V / 50 Hz	4.404 €
50 mm	3	R134A	220 V / 50 Hz	3.853 €
50 mm	4	R134A	220 V / 50 Hz	5.073 €
50 mm	4	R134A	220 V / 50 Hz	4.493 €

Yatay Buzdolaplar Servis Serisi/Camlı

Counter Refrigerators Service Series/With Glass



Service Line Series

Çekmece Seçenekleri / Drawer Options



- 3D** 1/3 Çekmece - 1/3 Drawers 597 €
- 2D** 1/2 Çekmece - 1/2 Drawers 551 €
- G** Cam Kapı - Glass Door 228 €
- 2/3D** 2/3 Çekmece - 2/3 Drawers 564 €

100 h. GN Kap : Üst Çekmece 1/3 Kazan
150 h. GN Kap : Üst Çekmece Çalışmaz
100 h. GN Cup : Upper Drawer 1/3 Case
150 h. GN Cup : Upper Drawer Will not Work

Cam Kapı Sadece Pozitif Kapılar İçindir
Glass Door Option is Only Available for Positive Doors

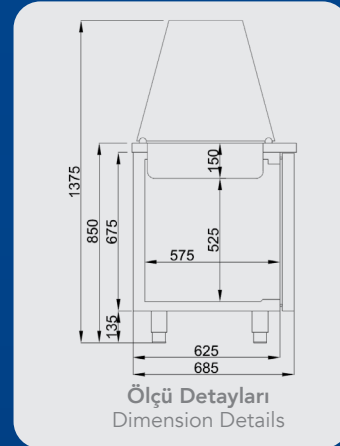

Option : 189 €

115 V / 60 Hz

Gastronom kaplar fiyata dahil değildir.

Gastronom cups are not included in the price.

Bilgi

- * İç Derinlik: 53 Cm (GN 1/1 Kapasiteli)
- * 35-40 Kg/m³ Çevre Dostu HCFC İçermeyen Poliüretan İzolasyon
- * Dijital Kumanda Paneli
- * Elektrik Rezistanslı Otomatik Defrost
- * Yüksekliği Ayarlanabilir Paslanmaz Ayaklar
- * Özel Kapı ve Menteşe Sistemi
- * Temizlenebilir ve Sökülebilir Manyetik Kapı Contası
- * Dış Ortam Sıcaklığı + 43°C & % 65 Nem
- * Işıklı Cam Bölüm
- * İstenirse Üst Tablada Farklı Şekilde Delikler Açılabilir.

Info

- * Inside Depth: 53 Cm (GN 1/1 Capacity)
- * 35-40 Kg/m³ Ecology Friendly HCFC Free Polyurethane Insulation
- * Digital Control Panel
- * Electrical Resistor Automatic Defrost
- * Stainless Steel Legs Adjustable for Height
- * Special Door and Hinge Systems
- * Removable and Easy Cleaning Magnetic Gasket
- * Ambient Temperature + 43°C & % 65 Humidity
- * Glass Cover with Light
- * Possibility To Open Different Wholing On the Unit

Kod Özellikleri / Available Codes

Raf ve Raf Kızağı / Shelf and Shelf Holder 49 €

W 90 €

Tekerlekli Wheels

DKP 30 €

Dijital Koruma Plastiği / Digital Cover

T 217 €

Touch Dijital / Touch Digital

WP 137 €

Su Geçirmez Dijital / Water Proof Digital

60hz 56 €

220 V
60 hz

K 70 €/Unt

Kilitli Kapı / With Lock

BT 418 €

Wi-Fi Dijital / Wi-Fi Digital

CGN3-SGC

Model Models	İç Sıcaklık Temperature °C	Brüt Hacim Gross volume Lt. GN-1/1x150	Ölçüler Dimensions Cm.	Paket Ölçüsü Packing Dim. Cm.	Ağırlık Weight Kg.	Paslanmaz Özelliği Stainless Steel Type	
	CGN2-SGC	-2/+8	4	140x70x85	150x80x100	150	304
	BGN2-SGC	-2/+8	4	140x70x85	150x80x100	150	430
	CGN3-SGC	-2/+8	5	186,5x70x85	197x80x100	180	304
	BGN3-SGC	-2/+8	5	186,5x70x85	197x80x100	180	430
	CGN4-SGC	-2/+8	6	233x70x85	243x80x100	200	304
	BGN4-SGC	-2/+8	6	233x70x85	243x80x100	200	430

İzolasyon Kalınlığı Insulation Thickness	Raf Adedi Shelf Unit	Soğutma Gazı Cooling Gas	Voltaj Voltage	Fiyat Price €
50 mm	2	R134A	220 V / 50 Hz	3.217 €
50 mm	2	R134A	220 V / 50 Hz	2.704 €
50 mm	3	R134A	220 V / 50 Hz	3.907 €
50 mm	3	R134A	220 V / 50 Hz	3.432 €
50 mm	4	R134A	220 V / 50 Hz	4.530 €
50 mm	4	R134A	220 V / 50 Hz	3.857 €

Model Models	Fiyat Price
CGN2-SGC-R290	3.189 €
BGN2-SGC-R290	2.677 €
CGN3-SGC-R290	3.879 €
BGN3-SGC-R290	3.405 €
CGN4-SGC-R290	4.502 €
BGN4-SGC-R290	3.830 €

Yatay Buzdolaplar Servis Serisi

Counter Refrigerators Service Series



Service Line Series

Çekmece Seçenekleri / Drawer Options



- 3D** 1/3 Çekmece - 1/3 Drawers 597 €
- 2D** 1/2 Çekmece - 1/2 Drawers 551 €
- G** Cam Kapı - Glass Door 228 €
- 2/3D** 2/3 Çekmece - 2/3 Drawers 564 €

100 h. GN Kap : Üst Çekmece 1/3 Kazan
150 h. GN Kap : Üst Çekmece Çalışmaz
100 h. GN Cup : Upper Drawer 1/3 Case
150 h. GN Cup : Upper Drawer Will not Work

Cam Kapı Sadece Pozitif Kapılar İçindir
Glass Door Option is Only Available for Positive Doors

Option : 189 €

115 V / 60 Hz

Gastronom kaplar fiyata dahil değildir.

Gastronom cups are not included in the price.

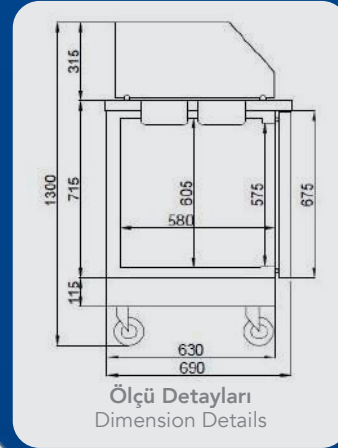

Ölçü Detayları
Dimension Details

KCN2

Bilgi

- * İç Derinlik: 53 Cm (GN 1/1 Kapasiteli)
- * 35-40 Kg/m³ Çevre Dostu HCFC İçermeyen Poliüretan İzolasyon
- * Dijital Kumanda Paneli
- * Elektrik Rezistanslı Otomatik Defrost
- * Yüksekliği Ayarlanabilir Paslanmaz Ayaklar
- * Özel Kapı ve Menteşe Sistemi
- * Temizlenebilir ve Sökülebilir Manyetik Kapı Contası
- * Dış Ortam Sıcaklığı + 43°C & % 65 Nem
- * Cam Bölüm Servise Uygun
- * İstenirse Üst Tablada Farklı Şekilde Delikler Açılabilir.

Info

- * Inside Depth: 53 Cm (GN 1/1 Capacity
- * 35-40 Kg/m³ Ecology Friendly HCFC Free Polyurethane Insulation
- * Digital Control Panel
- * Electrical Resistor Automatic Defrost
- * Stainless Steel Legs Adjustable for Height
- * Special Door and Hinge Systems
- * Removable and Easy Cleaning Magnetic Gasket
- * Ambient Temperature + 43°C & % 65 Nem
- * Glass Cover For Service
- * Possibility To Open Different Wholing On the Unit

Kod Özellikleri

Available Codes

Raf ve Raf Kızağı Shelf and Shelf Holder 49 €

W Tekerlekli Wheels 90 €

DKP Dijital Koruma Plastiği Digital Cover 30 €



T Touch Dijital Touch Digital 217 €

WP Su Geçirmez Dijital Water Proof Digital 137 €

60hz 220 V 60 hz 56 €

K Kilitli Kapı With Lock 70 €/Unit

BT Wi-Fi Dijital Wi-Fi Digital 418 €

Model Models	İç Sıcaklık Temperature °C	Brüt Hacim Gross volume Lt. GN 1/6x100	Ölçüler Dimensions Cm.	Paket Ölçüsü Packing Dim. Cm.	Ağırlık Weight Kg.	Paslanmaz Özelliği Stainless Steel Type
 KCN2	-2/+8	6	140x70x130	150x80x115	140	304
 KCN3	-2/+8	8	186,5x70x130	197x80x115	160	304
 KCN4	-2/+8	10	233x70x130	243x80x115	180	304

İzolasyon Kalınlığı Insulation Thickness	Raf Adedi Shelf Unit	Soğutma Gazı Cooling Gas	Voltaj Voltage	Fiyat Price €	Model Models	Fiyat Price
50 mm	2	R134A	220 V / 50 Hz	3.484 €	KCN2-R290	3.460 €
50 mm	3	R134A	220 V / 50 Hz	4.174 €	KCN3-R290	4.149 €
50 mm	4	R134A	220 V / 50 Hz	5.005 €	KCN4-R290	4.979 €



Kombinasyon Soğutmalı Buzdolapları 2 Kapılı/Prof. Line
Combination Refrigerators 2 Doors/Prof. Line

282-283

284-285

Kombinasyon Soğutmalı Buzdolapları 2 Kapılı
Combination Refrigerators 2 Door



Kombinasyon Soğutmalı Şok Soğutucu
Combination Refrigerator Blast Freezer

286-287

288-289

Kombinasyon Soğutmalı Buzdolapları 1 Kapılı
Combination Refrigerators 1 Door



Kombinasyon Soğutmalı Buzdolapları 3 Kapılı
Combination Refrigerators 3 Door

290-291

292-293

Kombinasyon Yatay Buzdolapları
Combination Counter Type Refrigerators



Yatay Buzdolapları - Kombinasyon
Counter Type Refrigerators - Combination

294-295



Combination
Line Series

Kombinasyon Soğutmalı Buzdolapları 2 Kapılı/Prof. Line

Combination Refrigerators 2 Doors/Prof. Line



Combination Line Series

GN 2/1

FP

Ayak Pedalı
Opsiyonu
Foot Pedal
Options

175€

Option : 189 €

115 V / 60 Hz

52 Adet Raf
Kapasitesi.
5 cm Aralıklı.
52 Unit Shelf
Holder Capacity.
5 cm Spaced.

KF



153€

Fanlı Kanopi
Canopy With Fan

Touch Dijital standart üretiminde mevcut değildir.
Fiyat için yan sayfaya bakınız.

Touch Digital is not available in standart production.
Check the options for the price.

VNN18-G

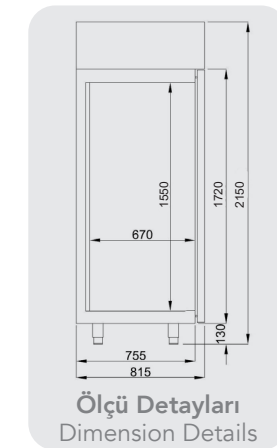

Ölçü Detayları
Dimension Details



85 mm İzolasyon
Kalınlığı
85 mm thickness



Ekstra Kuvvetli Dayanıklı
Fanlar Yüksek Hava Akışı
Strong Fans with maximum
air speed



Açılabilir Kanopiyle
Kolay Müdahale Olanağı
Front Cover Can be
Opened For Easy Access

Bilgi

- * Özel Kendinden Kalıplı Raf Sistemi
- * İç Derinlik: 65 Cm (GN 2/1 Kapasiteli)
- * 35-40 Kg/m³ Gazlı Çevre Dostu HCFC İçermeyen Poliüretan İzolasyon
- * Akıllı Defrost Sistemi
- * Otomatik Su Buharlaştırma Sistemi
- * Elektrikli Otomatik Defrost
- * Yüksekliği Ayarlanabilir Paslanmaz Ayaklar
- * Kapı Açıldığında Otomatik İç Aydınlatma
- * Özel, Kapı Menteşe Sistemi
- * Temizlenebilir ve Sökülebilir Manyetik Kapı Contası
- * Dış Ortam Sıcaklığı: + 43°C & % 65 Nem

Info

- * Special Self Shelving Design
- * Inside Depth: 65 Cm (GN 2/1 Capacity)
- * 35-40 Kg/m³ Ecology Friendly HCFC Free Polyurethane Insulation
- * Energy Saving Digital
- * Smart Defrost System
- * Automatic Water Evaporation System (Hot Gas)
- * Electrical Automatic Defrost
- * Stainless Steel Legs Adjustable For Height
- * Automatic Lighting Inside When Door is Open
- * Removable and Easy Cleaning Magnetic Gaskets
- * Ambient Temperature: + 43°C & % 65 Humidity

Kod Özellikleri Available Codes

Raf Shelf 42 €

W Tekerlekli / Wheels 90 €

T Touch Dijital Touch Digital 217 €

SE Görüntü Appearance 56 €

WP Su Geçirmez Dijital Water Proof Digital 137 €

-2 Yarım Kapı Half Door 192 €

BT Wi-Fi Dijital Wi-Fi Digital 418 €

60hz 220 V 60 hz 56 €

Model Models	İç Sıcaklık Temperature °C	Brüt Hacim Gross volume Lt.	Ölçüler Dimensions Cm.	Paket Ölçüsü Packing Dim. Cm.	Ağırlık Weight Kg.	Paslanmaz Özellikler Stainless Steel Type
VNN18	-2/+8 / -2/+8	1400	140x81x215	150x85x230	250	304
VNL18	-2/+8 / -10/-25	1400	140x81x215	150x85x230	260	304
VLL18	-10/-25 / -10/-25	1400	140x81x215	150x85x230	265	304
VNN18-G	-2/+8 / -2/+8	1400	140x81x215	150x85x230	265	304
VNL18-G	-2/+8 / -10/-25	1400	140x81x215	150x85x230	275	304
VLL18-G	-10/-25 / -10/-25	1400	140x81x215	150x85x230	290	304

İzolasyon Kalınlığı Insulation Thickness	Raf Adedi Shelf Unit	Soğutma Gazı Cooling Gas	Voltaj Voltage	Enerji Sınıfı Energy Rating	Kapı Adedi Door Unit	Fiyat Price €	Model Models	Fiyat Price
85 mm	6	R134	220 V / 50 Hz	E	2	6.403 €	VNN18-R290	6.375 €
85 mm	6	R134 R404A	220 V / 50 Hz	E	2	6.872 €	VNL18-R290	6.845 €
85 mm	6	R404A	220 V / 50 Hz	E	2	7.198 €	VLL18-R290	7.171 €
85 mm	6	R134	220 V / 50 Hz	E	2	7.416 €	VNN18-G-R290	7.389 €
85 mm	6	R134 R404A	220 V / 50 Hz	E	2	8.177 €	VNL18-G-R290	8.150 €
85 mm	6	R404A	220 V / 50 Hz	E	2	8.793 €	VLL18-G-R290	8.766 €

EF: Bu modellerde energy efficiency kondenser fanı kullanılmaktadır. / These models have energy efficiency condenser fans.

Kombinasyon Soğutmalı Buzdolapları 2 Kapılı

Combination Refrigerators 2 Door



Combination Line Series

Option : 189 €

115 V / 60 Hz

GN 2/1

58 Adet Raf Kapasitesi.
4,5 cm Aralıklı.
58 Unit Shelf Holder Capacity.
4,5 cm Spaced.

153€

Fanlı Kanopi
Canopy With Fan

VNL14

-2 °C +8 °C

-10 °C -25 °C

FP 175€

Ayak Pedali Opsiyonu
Foot Pedal Options

Ölçü Detayları
Dimension Details

Her Ürün İçin 10 Saatlik Performans Testi
10 Hours performance testing

Normal Cam Kapı
Glass Door
-2/+8°C 381 €

Derin Dondurucu Cam Kapı
Deep Freeze Glass Door
-2/+8°C 698 €

Değiştirilebilir Arasında Kir ve Bakteri Tutmayan Yüksek Manyetik Çekimli ÖZEL Conta
Special designed new gaskets. Can be removed, dirt-free

Cam Kapılar Yarım Kapıda Geçerli Değildir
Glass Door is not Available in Half Door

Kod Özellikleri
Available Codes

Raf ve Raf Kızağı
Shelf and Shelf Holder 49 €

W
Tekerlekli / Wheels 80 €

T
Touch Dijital Touch Digital 217 €

SE
Görüntü Appearance 56 €

WP
Su Geçirmez Dijital Water Proof Digital 137 €

-2
Yarım Kapı Half Door 192 €

BT
Wi-Fi Dijital Wi-Fi Digital 418 €

60hz
220 V / 60 hz 56 €

Bilgi

- * İç Derinlik: 65 Cm (GN 2/1 Kapasiteli)
- * 35-40 Kg/m3 Gazlı Çevre Dostu HCFC İçermeyen Poliüretan İzolasyon
- * Dijital Kumanda Paneli
- * Otomatik Su Buharlaştırma Sistemi
- * Elektrikli Otomatik Defrost
- * Yüksekliği Ayarlanabilir Paslanmaz Ayaklar
- * Kapı Açıldığında Otomatik İç Aydınlatma
- * Özel, Kapı Menteşe Sistemi
- * Temizlenebilir ve Sökülebilir Manyetik Kapı Contası
- * Dış Ortam Sıcaklığı: + 43°C & % 65 Nem

Info

- * Inside Depth: 65 Cm (GN 2/1 Capacity)
- * 35-40 Kg/m3 Ecology Friendly HCFC Free Polyurethane Insulation
- * Digital Control Panel
- * Automatic Water Evaporation System
- * Electrical Automatic Defrost
- * Stainless Steel Legs Adjustable For Height
- * Automatic Lighting Inside When Door is Open.
- * Special Door and Hinge Systems
- * Removable and Easy Cleaning Magnetic Gaskets
- * Ambient Temperature: + 43°C & % 65 Humidity

Model Models	İç Sıcaklık Temperature °C	Brüt Hacim Gross volume Lt.	Ölçüler Dimensions Cm.	Paket Ölçüsü Packing Dim. Cm.	Ağırlık Weight Kg.	Paslanmaz Özelligi Stainless Steel Type
VNN14	-2/+8	1400	140x81x205	150x85x220	245	304
VNL14	-2/+8 (1 Door) -10/-22 (1 Door)	1400	140x81x205	150x85x220	250	304
VLL14	-10/-22	1400	140x81x205	150x85x220	255	304
VNL14-3T	-2/+8 -5/0 (1 Half Door Fish) -10/-22 (1 Half Door)	1400	140x81x205	150x85x220	305	304
VNL14-4T	-2/+8 (1 Half Door) -5/0 (1 Half Door) -10/-22 (1 Half Door) 0/+5 (1 Half Door)	1400	140x81x205	150x85x220	310	304

İzolasyon Kalınlığı Insulation Thickness	Raf Adedi Shelf Unit	Soğutma Gazı Cooling Gas	Voltaj Voltage	Enerji Sınıfı Energy Rating	Kapı Adedi Door Unit	Fiyat Price €	Model Models	Fiyat Price
60 mm	6	R134A	220 V / 50 Hz	E	2	5.299 €	VNN14-R290	5.272 €
60 mm	6	R134A R404A	220 V / 50 Hz	E	2	5.769 €	VNL14-R290	5.741 €
60 mm	6	R134A R404A	220 V / 50 Hz	E	2	6.263 €	VLL14-R290	6.249 €
60 mm	7	R134A R404A	220 V / 50 Hz	E	3	7.615 €	VNL14-3T-R290	7.588 €
60 mm	8	R134A R404A	220 V / 50 Hz	E	4	9.389 €	VNL14-4T-R290	9.361 €

EF: Bu modellerde energy efficiency kondenser fanı kullanılmaktadır. / These models have energy efficiency condenser fans.

Kombinasyon Soğutmalı Şok Soğutucu

Combination Refrigerator Blast Freezer



Combination Line Series

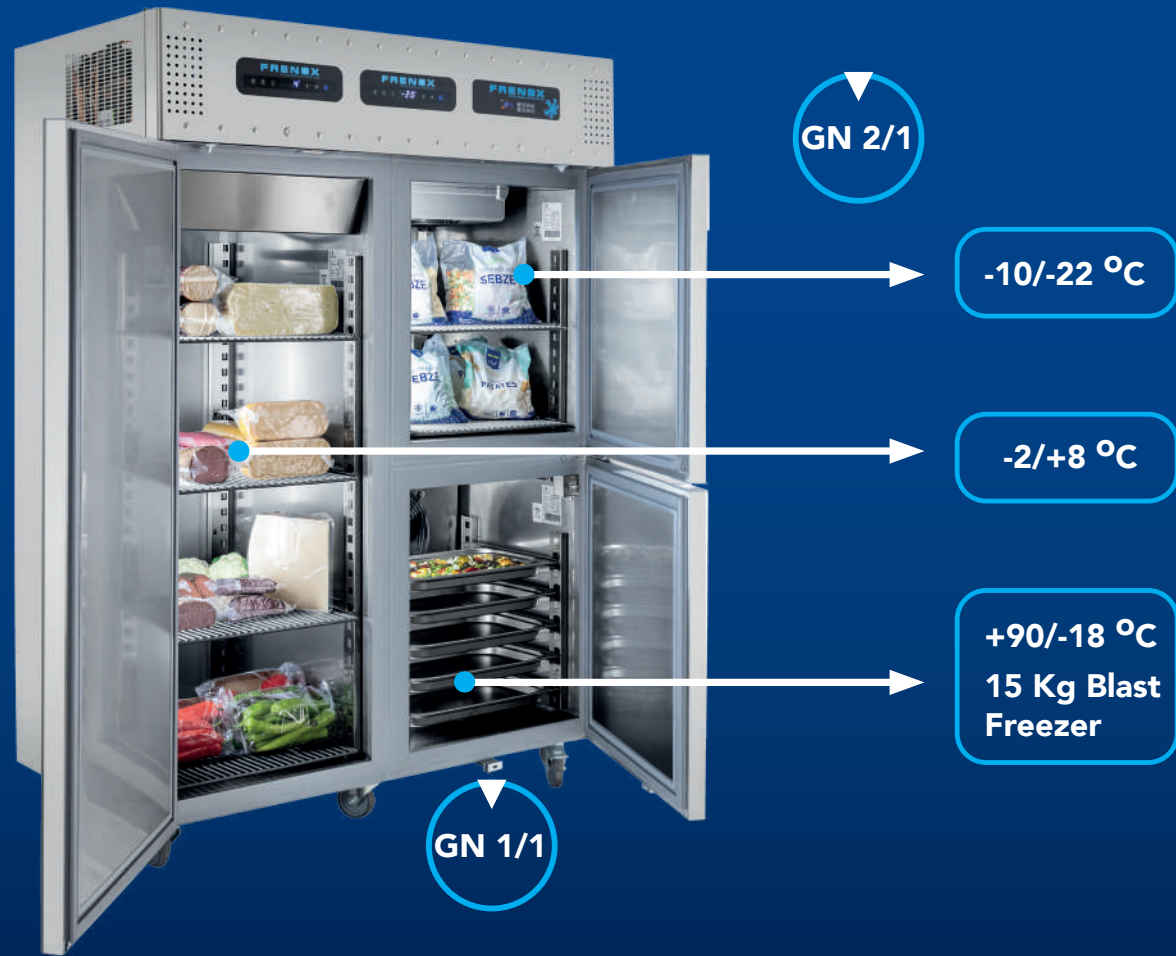

VBN14-3



VBL14-3

Bilgi

- * İç Derinlik: 65 Cm (GN 2/1 Kapasiteli)
- * 35-40 Kg/m³ Gazlı Çevre Dostu HCFC İçermeyen Poliüretan İzolasyon
- * Dijital Kumanda Paneli
- * Otomatik Su Buharlaştırma Sistemi
- * Elektrikli Otomatik Defrost
- * Yüksekliği Ayarlanabilir Paslanmaz Ayaklar
- * Kapı Açıldığında Otomatik İç Aydınlatma
- * Özel, Kapı Menteşe Sistemi
- * Temizlenebilir ve Sökülebilir Manyetik Kapı Contası
- * Dış Ortam Sıcaklığı: + 38°C & % 65 Nem

Info

- * Inside Depth: 65 Cm (GN 2/1 Capacity)
- * 35-40 Kg/m³ Ecology Friendly HCFC Free Polyurethane Insulation
- * Digital Control Panel
- * Automatic Water Evaporation System
- * Electrical Automatic Defrost
- * Stainless Steel Legs Adjustable For Height
- * Automatic Lighting Inside When Door is Open.
- * Special Door and Hinge Systems
- * Removable and Easy Cleaning Magnetic Gaskets
- * Ambient Temperature: + 38°C & % 65 Humidity

Kod Özellikleri

Available Codes

Raf ve Raf Kızağı
Shelf and Shelf Holder 49 €

W
Tekerlekli / Wheels 90 €

T
Touch Dijital
Touch Digital 217 €

WP
Su Geçirmez Dijital
Water Proof Digital 137 €

-2
Yarım Kapı
Half Door 192 €

BT
Wi-Fi Dijital
Wi-Fi Digital 418 €

60_{hz}
220 V / 60 Hz x2 56 €

Model Models	İç Sıcaklık Temperature °C	Brüt Hacim Gross volume Lt.	Ölçüler Dimensions Cm.	Paket Ölçüsü Packing Dim. Cm.	Ağırlık Weight Kg.	Paslanmaz Özelliği Stainless Steel Type
VBN14-3	-2/+8 (Full Door) -10/-22 (1 Half Door) +90/-18 (1 Half Door) 15 Kg Freezing Capacity	1400	140x81x205	150x85x220	245	304
VBL14-3	-10/-22 (1 Full Door)- 2/+8 (Half Door) +90/-18 (1 Half Door) 15 Kg Freezing Capacity	1400	140x81x205	150x85x220	305	304

İzolasyon Kalınlığı Insulation Thickness	Raf Adedi Shelf Unit	Soğutma Gazı Cooling Gas	Voltaj Voltage	Kapı Adedi Door Unit	Fiyat Price €	Model Models	Fiyat Price
60 mm	6	R134A R404A	220 V / 50 Hz	3	9.596 €	VBN14-3 R290-452	9.568 €
60 mm	8	R134A R404A	220 V / 50 Hz	3	9.744 €	VBL14-3 R290-452	9.716 €

Kombinasyon Soğutmalı Buzdolapları 1 Kapılı

Combination Refrigerators 1 Door



Combination Line Series



GN 2/1

Option : 189 €

115 V / 60 Hz

24 Adet Raf Kapasitesi.
4,5 cm Aralıklı.
24 Unit Shelf Holder Capacity.
4,5 cm Spaced.

KF



89€

Fanlı Kanopi
Canopy With Fan

VNL7

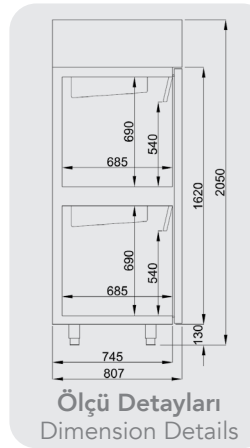

Ölçü Detayları
Dimension Details



Her Ürün İçin
10 Saatlik
Performans Testi
10 Hours
performance testing



Değiştirilebilir Arasında Kir
ve Bakteri Tutmayan Yüksek
Manyetik Çekimli ÖZEL
Conta
Special designed new gaskets.
Can be removed, dirt-free

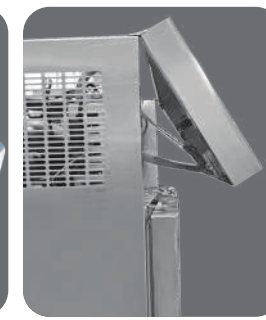

Açılabilir Kanopiyle
Kolay Müdahale Olanağı
Front Cover Can be
Opened For Easy Access

Kod Özellikleri
Available Codes

Raf ve Raf Kızağı
Shelf and
Shelf
Holder
49 €

W
Tekerlekli / Wheels
90 €

T
Touch Dijital
Touch Digital
217 €

WP
Su Geçirmez Dijital
Water Proof Digital
137 €

BT
Wi-Fi Dijital
Wi-Fi Digital
418 €

L
Sol Kapı
(Dikey)
Left Door
(Upright)
30 €

60hz
220 V
60 hz
56 €

Bilgi

- * İç Derinlik: 65 Cm (GN 2/1 Kapasiteli)
- * 35-40 Kg/m³ Gazlı Çevre Dostu HCFC İçermeyen Poliüretan İzolasyon
- * Dijital Kumanda Paneli
- * Otomatik Su Buharlaştırma Sistemi
- * Elektrikli Otomatik Defrost
- * Yüksekliği Ayarlanabilir Paslanmaz Ayaklar
- * Kapı Açıldığında Otomatik İç Aydınlatma
- * Özel, Kapı Mentеше Sistemi
- * Temizlenebilir ve Sökülebilir Manyetik Kapı Contası
- * CFC Free Soğutma Gazı: R 134 A / R 404 A
- * Dış Ortam Sıcaklığı: + 43°C & % 65 Nem

Info

- * Inside Depth: 65 Cm (GN 2/1 Capacity)
- * 35-40 Kg/m³ Ecology Friendly HCFC
- * Free Polyurethane Insulation
- * Digital Control Panel
- * Automatic Water Evaporation System
- * Electrical Automatic Defrost
- * Stainless Steel Legs Adjustable For Height
- * Automatic Lighting Inside When Door is Open.
- * Special Door and Hinge Systems
- * Removable and Easy Cleaning Magnetic Gaskets
- * Cooling Gas CFC Free: R 134 A / R 404 A
- * Ambient Temperature: + 43°C & % 65 Humidity

Model Models	İç Sıcaklık Temperature °C	Brüt Hacim Gross volume Lt.	Ölçüler Dimensions Cm.	Paket Ölçüsü Packing Dim. Cm.	Ağırlık Weight Kg.	Paslanmaz Özellikçi Stainless Steel Type
VNN7	-2/+8	700	70x81x205	80x85x220	173	304
VNL7	-2/+8 (1 Half Door) -10/-22 (1 Half Door)	700	70x81x205	80x85x220	183	304
VLL7	-10/-22	700	70x81x205	80x85x220	183	304
VNS7	-2/+8 (1 Door) -5/0 (1 Fish)	700	70x81x205	80x85x220	170	304
VLS7	-10/-22 (1 Door) -5/0 (1 Fish)	700	70x81x205	80x85x220	180	304

İzolasyon Kalınlığı Insulation Thickness	Raf Adedi Shelf Unit	Soğutma Gazı Cooling Gas	Voltaj Voltage	Enerji Sınıfı Energy Rating	Kapı Adedi Door Unit	Fiyat Price €	Model Models	Fiyat Price
60 mm	4	R134A	220 V / 50 Hz	E	2	4.609 €	VNN7-R290	4.581 €
60 mm	4	R134A R404A	220 V / 50 Hz	E	2	4.756 €	VNL7-R290	4.729 €
60 mm	4	R404A R404A	220 V / 50 Hz	E	2	5.052 €	VLL7-R290	5.024 €
60 mm	4	R134A R404A	220 V / 50 Hz	E	2	5.348 €		
60 mm	4	R134A R404A	220 V / 50 Hz	E	2	5.495 €		

EF: Bu modellerde energy efficiency kondenser fanı kullanılmaktadır. / These models have energy efficiency condenser fans.

Kombinasyon Yatay Buzdolapları

Combination Counter Type Refrigerators



Combination Line Series

Çekmece Seçenekleri / Drawer Options

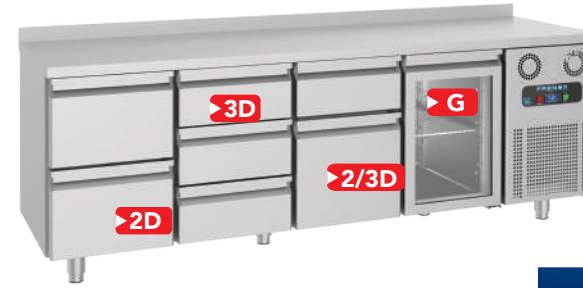

- 3D** 1/3 Çekmece - 1/3 Drawers 678 €
- 2D** 1/2 Çekmece - 1/2 Drawers 534 €
- G** Cam Kapı - Glass Door 234 €
- 2/3D** 2/3 Çekmece - 2/3 Drawers 589 €

Cam Kapı Sadece Pozitif Kapılar İçindir
Glass Door Option is Only Available for Positive Doors

Option : 189 €

115 V / 60 Hz

Bilgi

- * İç Derinlik: 43 Cm / 53 Cm (GN 1/1 Kapasiteli)
- * 35-40 Kg/m³ Çevre Dostu HCFC İçermeyen Poliüretan İzolasyon
- * Dijital Kumanda Paneli
- * Elektrik Rezistanslı Otomatik Defrost
- * Özel Su Buharlaştırma Sistemi
- * Yüksekliği Ayarlanabilir Paslanmaz Ayaklar
- * Özel, Kapı Mentеше Sistemi
- * Temizlenebilir ve Sökülebilir Manyetik Kapı Contası
- * Dış Ortam Sıcaklığı: + 43°C & % 65 Nem

Info

- * Inside Depth: 43 Cm / 53 Cm (GN 1/1 Capacity)
- * 35-40 Kg/m³ Ecology Friendly HCFC Free Polyurethane Insulation
- * Digital Control Panel
- * Electrical Resistor Automatic Defrost
- * Special Water Evaporation
- * Stainless Steel Legs Adjustable For Height
- * Special Door and Hinge Systems
- * Removable and Easy Cleaning Magnetic Gaskets
- * Ambient Temperature: + 43°C %65 Humidity

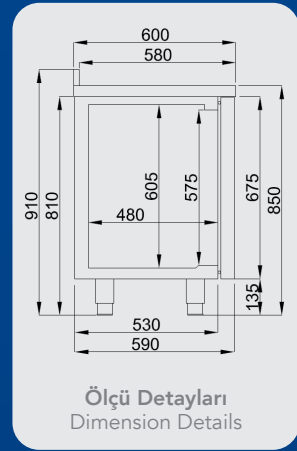

Ölçü Detayları
Dimension Details

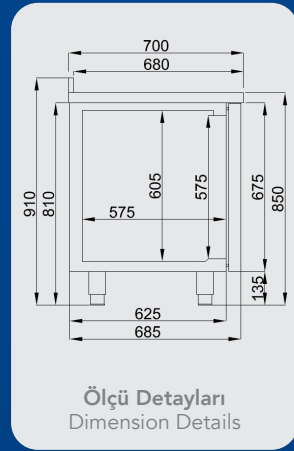

Ölçü Detayları
Dimension Details



CGNL4

Model Models	İç Sıcaklık Temperature °C	Brüt Hacim Gross volume Lt.	Ölçüler Dimensions Cm.	Paket Ölçüsü Packing Dim. Cm.	Ağırlık Weight Kg.	Paslanmaz Özellği Stainless Steel Type
CSNL4	-2/+8 -10/-20	550	233x60x85	243x70x100	215	304
CGNL4	-2/+8 -10/-20	632	233x70x85	243x80x100	225	304
BSNL4	-2/+8 -10/-20	550	233x60x85	243x70x100	215	430
BGNL4	-2/+8 -10/-20	632	233x70x85	243x80x100	225	430

İzolasyon Kalınlığı Insulation Thickness	Raf Adedi Shelf Unit	Soğutma Gazı Cooling Gas	Voltaj Voltage	Enerji Sınıfı Energy Rating	Fiyat Price €	Model Models	Fiyat Price
50 mm	4	R134A R404A	220 V / 50 Hz	E	5.303 €	CSNL4-R290	5.276 €
50 mm	4	R134A R404A	220 V / 50 Hz	E	5.495 €	CGNL4-R290	5.468 €
50 mm	4	R134A R404A	220 V / 50 Hz	E	4.621 €	BSNL4-R290	4.594 €
50 mm	4	R134A R404A	220 V / 50 Hz	E	4.837 €	BGNL4-R290	4.810 €

Kod Özellikleri Available Codes

W 90 €
Tekerlekli Wheels

DZ 0 €
Düz Üst Tabla Straight Work Top

A 70 €
10 cm Yuvarlatılmış Sırtlı Tabla 10 cm Curved Splashback Work Top

GR 1.307 €
Granit Üst Tabla Granite Work Top

MR 691 €
Mermer Üst Tabla Marble Work Top

PL 1.249 €
Poliyeten Üst Tabla Polyethylene Work Top

F 304 : -194 €
430 : -117 €
Üst Tablasız Without Work Top

DKP 30 €
x2 Dijital Koruma Plastiği Digital Cover

T 217 €
x2 Touch Dijital Touch Digital

WP 137 €
x2 Su Geçirmez Dijital Water Proof Digital

60hz 56 €
220 V 60 hz

L 30 €
Sol Motor (Dikey) Left Motor (Upright)

BT 418 €
x2 Wi-Fi Dijital Wi-Fi Digital

K 670 €/Unit
Kilitli Kapı With Lock

EF: Bu modellerde energy efficiency kondenser fanı kullanılmaktadır. / These models have energy efficiency condenser fans.

Yatay Buzdolapları-Kombinasyon/Prof. Line 3 Kapılı

Counter Type Refrigerators-Combination/Prof. Line 3 Doors



Combination Line Series

Çekmece Seçenekleri / Drawer Options

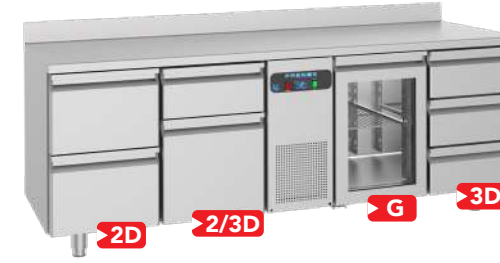

- 3D** 1/3 Çekmece - 1/3 Drawers 678 €
- 2D** 1/2 Çekmece - 1/2 Drawers 534 €
- G** Cam Kapı - Glass Door 234 €
- 2/3D** 2/3 Çekmece - 2/3 Drawers 589 €

Cam Kapı Sadece Pozitif Kapılar İçindir
Glass Door Option is Only Available for Positive Doors

Freezer and Positive side can not work independently. Positive side cooling will take longer to reach set temperature then the freezer side. / Soğutucu ve dondurucu bölüm bağımsız olarak çalışmamaktadır. Soğutucu bölümün belirlenen sıcaklık aralığına düşmesi dondurucu bölümden daha uzun sürmektedir.

Bilgi

- * İç Derinlik : 43 Cm / 53 Cm (GN 1/1 Kapasiteli)
- * 35/40 Kg/m³ Çevre Dostu HCFC Free Poliüretan İzolasyon
- * Dijital Kumanda Paneli
- * Elektrik Rezistanslı Otomatik Defrost
- * Özel Su Buharlaştırma Sistemi
- * Yüksekliği Ayarlanabilir Paslanmaz Ayaklar
- * Özel, Kapı Menteşe Sistemi
- * Temizlenebilir ve Sökülebilir Manyetik Kapı Contası
- * Dış Ortam Sıcaklığı: + 43°C & % 65 Nem

Info

- * Inside Depth: 43 Cm / 53 Cm (GN 1/1 Capacity)
- * 35/40 Kg/m³ Ecology Friendly HCFC Free Polyurethane Isolation
- * Digital Control Panel
- * Electrical Resistor Automatic Defrost
- * Special Water Evaporation
- * Legs Adjustable For Height
- * Special Hinges and Door System
- * Removable and Easy Cleaning Magnetic Gaskets
- * Ambient Temperature: + 43°C % 65 Humidity

Option : 189 €

115 V / 60 Hz

Özel Kendinden Kapanan Çekmece
Special Self Closing Drawer

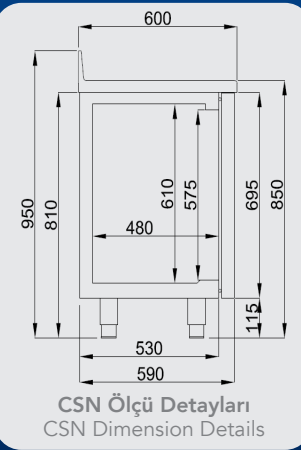
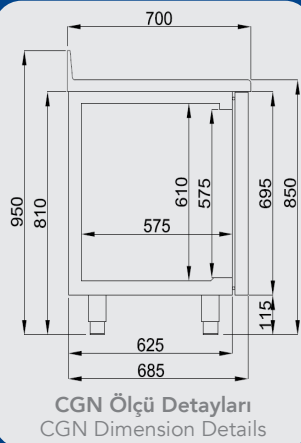

Standart Sirt Yüksekliği 10 cm'dir.
Standart Splash Back Height is 10 cm.







Monoblok Soğutma Sistemi
Monoblock Cooling Group

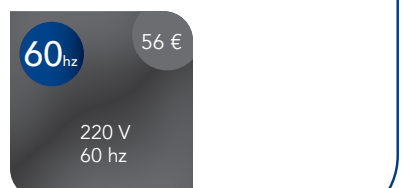
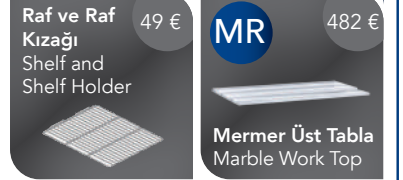

CGLN3-M-A

Kod Özellikleri Available Codes



Model Models	İç Sıcaklık Temperature °C	Brüt Hacim Gross volume Lt.	Ölçüler Dimensions Cm.	Paket Ölçüsü Packing Dim. Cm.	Ağırlık Weight Kg.	Paslanmaz Özelliği Stainless Steel Type
 CGNL3-M	Sağ/Right -10/-22 Sol/Left -2/+8	474	178,5x70x85	188,5x80x105	185	304
 CSNL3-M	Sağ/Right -10/-22 Sol/Left -2/+8	400	178,5x60x85	188,5x70x105	175	304
 CGLN3-M	Sağ/Right -2/+8 Sol/Left -10/-22	474	178,5x70x85	188,5x80x105	185	304
 CSLN3-M	Sağ/Right -2/+8 Sol/Left -10/-22	400	178,5x60x85	188,5x70x105	175	304

İzolasyon Kalınlığı Insulation Thickness	Raf Adedi Shelf Unit	Soğutma Gazı Cooling Gas	Voltaj Voltage	Enerji Sınıfı Energy Rating	Fiyat Price €	Model Models	Fiyat Price
60 mm	3	R404A	220 V / 50 Hz	E	4.674 €	CGNL3-M-R290	4.649 €
60 mm	3	R404A	220 V / 50 Hz	E	4.668 €	CSNL3-M-R290	4.641 €
60 mm	3	R404A	220 V / 50 Hz	E	5.006 €	CGLN3-M-R290	4.980 €
60 mm	3	R404A	220 V / 50 Hz	E	5.000 €	CSLN3-M-R290	4.973 €

Yatay Buzdolapları-Kombinasyon/Prof. Line 4 Kapılı

Counter Type Refrigerators-Combination/Prof. Line 4 Doors



Monoblok Soğutma Sistemi
Monoblock Cooling Group



Özel Kendinden Kapanan Çekmece
Special Self Closing Drawer

Option : 189 €

115 V / 60 Hz

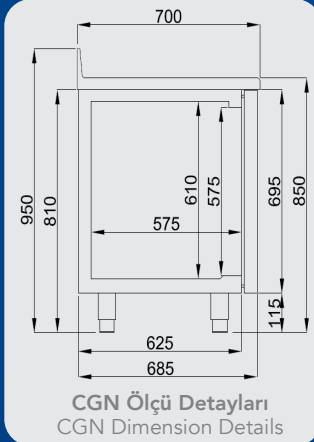

CGN Ölçü Detayları
CGN Dimension Details

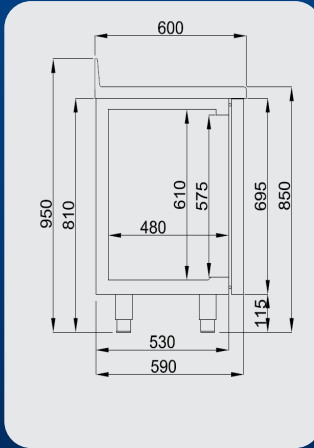

Standart Sırt Yüksekliği 10 cm'dir.
Standart Splash Back Height is 10 cm.

CGNL4-M-A



FRENOX
PROFESSIONAL REFRIGERATION

Combination Line Series

Çekmece Seçenekleri / Drawer Options



- 3D** 1/3 Çekmece - 1/3 Drawers 678 €
- 2D** 1/2 Çekmece - 1/2 Drawers 534 €
- G** Cam Kapı - Glass Door 234 €
- 2/3D** 2/3 Çekmece - 2/3 Drawers 589 €

Cam Kapı Sadece Pozitif Kapılar İçindir
Glass Door Option is Only Available for Positive Doors

Freezer and Positive side can not work independently. Positive side cooling will take longer to reach set temperature then the freezer side. / Soğutucu ve dondurucu bölüm bağımsız olarak çalışmamaktadır. Soğutucu bölümün belirlenen sıcaklık aralığına düşmesi dondurucu bölümden daha uzun sürmektedir.

Bilgi





- * İç Derinlik : 43 Cm / 53 Cm (GN 1/1 Kapasiteli)
- * 35/40 Kg/m³ Çevre Dostu HCFC Free Poliüretan İzolasyon
- * Dijital Kumanda Paneli
- * Elektrik Rezistanslı Otomatik Defrost
- * Özel Su Buharlaştırma Sistemi
- * Yüksekliği Ayarlanabilir Paslanmaz Ayaklar
- * Özel, Kapı Menteşe Sistemi
- * Temizlenebilir ve Sökülebilir Manyetik Kapı Contası
- * Dış Ortam Sıcaklığı: + 43°C & % 65 Nem

Info

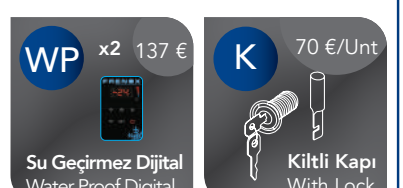
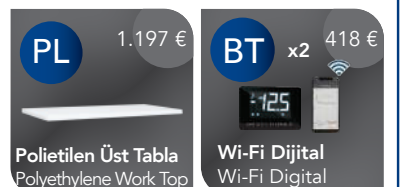
- * Inside Depth: 43 Cm / 53 Cm (GN 1/1 Capacity)
- * 35/40 Kg/m³ Ecology Friendly HCFC Free Polyurethane Isolation
- * Digital Control Panel
- * Electrical Resistor Automatic Defrost
- * Special Water Evaporation
- * Legs Adjustable For Height
- * Special Hinges and Door System
- * Removable and Easy Cleaning Magnetic Gaskets
- * Ambient Temperature: + 43°C % 65 Humidity

Kod Özellikleri Available Codes



Model Models	İç Sıcaklık Temperature °C	Brüt Hacim Gross volume Lt.	Ölçüler Dimensions Cm.	Paket Ölçüsü Packing Dim. Cm.	Ağırlık Weight Kg.	Paslanmaz Özelliği Stainless Steel Type
 CGNL4-M	Sağ/Right -10/-22 Sol/Left -2/+8	632	227x70x85	237x80x105	210	304
 CSNL4-M	Sağ/Right -10/-22 Sol/Left -2/+8	550	227x60x85	237x70x105	200	304
 CGLN4-M	Sağ/Right -2/+8 Sol/Left -10/-22	632	227x70x85	237x80x105	210	304
 CSLN4-M	Sağ/Right -2/+8 Sol/Left -10/-22	550	227x60x85	237x70x105	200	304

İzolasyon Kalınlığı Insulation Thickness	4Raf Adedi Shelf Unit	Soğutma Gazı Cooling Gas	Voltaj Voltage	Enerji Sınıfı Energy Rating	Fiyat Price €	Model Models	Fiyat Price
60 mm	4	R404A	220 V / 50 Hz	E	5.338 €	CGNL4-M-R290	5.312 €
60 mm	4	R404A	220 V / 50 Hz	E	5.331 €	CSNL4-M-R290	5.306 €
60 mm	4	R404A	220 V / 50 Hz	E	5.338 €	CGLN4-M-R290	5.312 €
60 mm	4	R404A	220 V / 50 Hz	E	5.331 €	CSLN4-M-R290	5.306 €

300-301

Donmuş Gıda Çözdürme Kabini 1 Kapılı
Thawing Cabinet 1 Door



318-319

Krep Hazırlık Buzdolabı
Crepe Table Refrigerator



Panel Dik Buzdolabı 1 Kapılı
Panel Vertical Refrigerator 1 Door

302-303



Dikey Buzdolapları Roll-In Serisi
Vertical Refrigerators Roll-In Series

320-321

304-305

Panel Dik Buzdolabı 2 Kapılı
Panel Vertical Refrigerator 2 Door



322-323

Dikey Buzdolapları Roll-In Serisi
Vertical Refrigerators Roll-In Series



Soğuk Banket Arabası
Cold Banquet Trolley

306-307



Çöp Buzdolabı - Mono Blok
Waste Refrigerator - Mono Block

324-325

308-309

Monoblok Soğuk Oda
Monoblock Cold Room



Dondurma Buzdolapları 1 Kapılı
Vertical Refrigerators 1 Door

310-311

312-313

Çikolata Saklama Buzdolabı
Chocolate Storage Refrigerator



Dikey Buzdolapları İki Tarafta Kapılı
Vertical Refrigerators Pass Through

314-315

316-317

Yatay Buzdolapları Ada Serisi
Counter Refrigerators Island Series



Donmuş Gıda Çözdürme Kabini 1 Kapılı

Thawing Cabinet - 1 Door

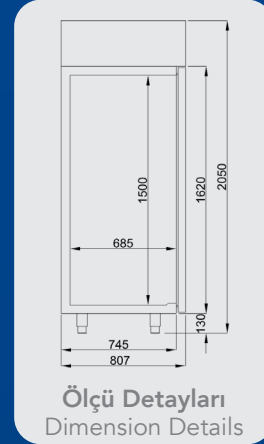

Option : 189 €

115 V / 60 Hz

Bakteri üremesini önleme
Avoid bacteria growth

Özelleştirilebilir çözdürme işlemi
Customisable thawing process

FP

Ayak Pedalı Opsiyonu
Foot Pedal Options

89€

GN 2/1

VN7-THW-R290



FRENOX
PROFESSIONAL REFRIGERATION

Special Line Series



Karkas Etlerin Çözdürme İşlemini Kolaylaştıran Et Askıları
Meat Hangers to Thawing Process of Carcass Meat Pieces



Açılabilir Kanopiyle Kolay Müdahale Olanağı
Front Cover Can be Opened For Easy Access

Kod Özellikleri
Available Codes

Raf ve Raf Kızağı
Shelf and Shelf Holder 49 €

W
Tekerlekli / Wheels 90 €

T
Touch Dijital
Touch Digital 217 €

SE
Görüntü
Appearance 56 €

WP
Su Geçirmez Dijital
Water Proof Digital 137 €

-2
Yarım Kapı
Half Door 197 €

BT
Wi-Fi Dijital
Wi-Fi Digital 418 €

L
Sol Kapı (Dikey)
Left Door (Upright) 30 €

60hz
220 V
60 hz 56 €

LED
LED Aydınlatma
LED Lighting 85 €

Bilgi

- * İç Derinlik: 65 Cm (GN 2/1 Kapasiteli)
- * 35-40 Kg/m³ Gazlı Çevre Dostu HCFC İçermeyen Poliüretan İzolasyon
- * Dijital Kumanda Paneli
- * Otomatik Su Buharlaştırma Sistemi
- * Elektrikli Otomatik Defrost
- * Hızlı ve uniform donmuş gıda çözdürme
- * Tazeliği koruma
- * Bakteri üremesini önleme
- * Yüksek hava akışı
- * Özelleştirilebilir çözdürme işlemi
- * Dış Ortam Sıcaklığı: + 43°C & % 65 Nem

Info

- * Inside Depth: 65 Cm (GN 2/1 Capacity)
- * 35-40 Kg/m³ Ecology Friendly HCFC Free Polyurethane Insulation
- * Digital Control Panel
- * Automatic Water Evaporation System
- * Electrical Automatic Defrost
- * Quick and uniform thawing process
- * Keep freshness after thawing process
- * Avoid bacteria growth
- * High airflow
- * Customisable thawing process
- * Ambient Temperature: + 43°C & % 65 Humidity

Model Models	İç Sıcaklık Temperature °C	Brüt Hacim Gross volume Lt.	Ölçüler Dimensions Cm.	Paket Ölçüsü Packing Dim. Cm.	Ağırlık Weight Kg.	Paslanmaz Özelliği Stainless Steel Type
VN7-THW-R290	-2/+10	700	70X81X205	80X85X220	138	304

İzolasyon Kalınlığı Insulation Thickness	Et Askısı Adedi Meat Hanger Unit	Raf Adedi Shelf Unit	Soğutma Gazı Cooling Gas	Voltaj Voltage	Enerji Sınıfı Energy Rating	Kapı Adedi Door Unit	Model Models	Fiyat Price
60mm	2	8	R290	220V / 50 Hz	E	1	VN7-THW-R290	7.957 €

EF: Bu modellerde energy efficiency kondenser fanı kullanılmaktadır. / These models have energy efficiency condenser fans.

Panel Dik Buzdolabı 1 Kapılı

Panel Vertical Refrigerator 1 Door



FRENOX
PROFESSIONAL REFRIGERATION

Special Line Series

GN 2/1

Modüler
Panel Buzdolabı
Modular Panel

31 Adet Raf
Kapasitesi.
4,5 cm Aralıklı.
31 Unit Shelf
Holder Capacity.
4,5 cm Spaced.

Option : 189 €

115 V / 60 Hz

PA-VN7

Panel şeklinde nakliyyede %80'e varan avantaj.
40'lık konteynır / Tek kapılı dolap için.

When loaded as panels, ability to load up to %80 more products.
40 feet container / One door refrigerator.

KF



89€

Fanlı Kanopi
Canopy With
Fan

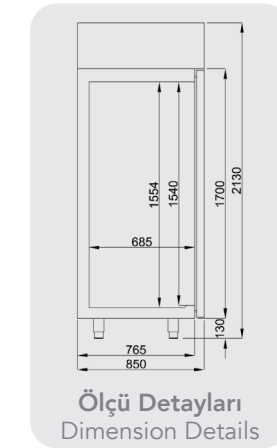

Ölçü Detayları
Dimension Details



Monoblok
Soğutma Sistemi
Monoblock Cooling
Group

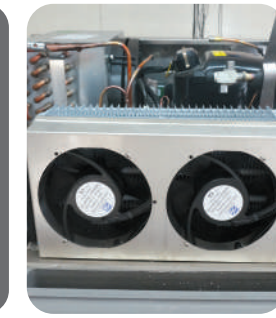

Ekstra Kuvvetli Dayanıklı
Fanlar Yüksek Hava Akışı
Strong Fans with maximum
air speed



Tek Kapıda %17, Çift
Kapıda %34 Fazla İç Hacim
More Storage Volume %17
in One Door, %34 in Two
Door Cabinet

Bilgi

- * Modüler Panel Şeklinde Montaj ve Söküm Kolaylığı
- * İç Derinlik: 65 Cm (GN 2/1 Kapasiteli)
- * 35-40 Kg/m³ Gazlı Çevre Dostu HCFC İçermeyen Poliüretan İzolasyon
- * Dijital Kumanda Paneli
- * Otomatik Su Buharlaştırma Sistemi
- * Elektrikli Otomatik Defrost
- * Yüksekliği Ayarlanabilir Paslanmaz Ayaklar
- * Kapı Açıldığında Otomatik İç Aydınlatma
- * Özel, Kapı Menteşe Sistemi
- * Temizlenebilir ve Sökülebilir Manyetik Kapı Contası
- * Dış Ortam Sıcaklığı: + 43°C & % 65 Nem

Info

- * Modular - Panel Shaped Assembly and Disassembly Facility
- * Inside Depth: 65 Cm (GN 2/1 Capacity)
- * 35-40 Kg/m³ Ecology Friendly HCFC Free Polyurethane Insulation
- * Digital Control Panel
- * Smart Defrost System
- * Automatic Water Evaporation System (Hot Gas)
- * Electrical Automatic Defrost
- * Stainless Steel Legs Adjustable For Height
- * Automatic Lighting Inside When Door is Open
- * Removable and Easy Cleaning Magnetic Gaskets
- * Ambient Temperature: + 43°C & % 65 Humidity

Kod Özellikleri

Available Codes

Raf ve Raf Kızağı
Shelf and
Shelf
Holder 49 €

W Tekerlekli / Wheels 90 €

T Touch Dijital
Touch Digital 217 €

V Görüntü
Appearance 56 €

SE Görüntü
Appearance 56 €

WP Su Geçirmez Dijital
Water Proof Digital 137 €

BT Wi-Fi Dijital
Wi-Fi Digital 418 €

L Sol Kapı
(Dikey)
Left Door
(Upright) 30 €

60^{hz} 220 V /
60 hz 56 €

İzolasyon Kalınlığı Insulation Thickness	Raf Adedi Shelf Unit	Soğutma Gazı Cooling Gas	Voltaj Voltage	Enerji Sınıfı Energy Rating	Kapı Adedi Door Unit	Fiyat Price €	Model Models	Fiyat Price
80 mm	3	R134A	220 V / 50 Hz	E	1	3.500 €	PA-VN7-R290	3.472 €
80 mm	3	R404A	220 V / 50 Hz	E	1	3.841 €	PA-VL7-R290	3.813 €
80 mm	3	R134A	220 V / 50 Hz	E	1	2.999 €	PA-VL7-R290	2.972 €
80 mm	3	R404A	220 V / 50 Hz	E	1	3.343 €	PA-BL7-R290	3.317 €
80 mm	3	R134A	220 V / 50 Hz	E	1	4.015 €	PA-VN7-G-R290	3.987 €
80 mm	3	R404A	220 V / 50 Hz	E	1	4.712 €	PA-VL7-G-R290	4.685 €
80 mm	3	R134A	220 V / 50 Hz	E	1	3.526 €	PA-BN7-G-R290	3.500 €
80 mm	3	R404A	220 V / 50 Hz	E	1	4.258 €	PA-BL7-G-R290	4.232 €

Model Models	İç Sıcaklık Temperature °C	Brüt Hacim Gross volume Lt.	Ölçüler Dimensions Cm.	Paket Ölçüsü Packing Dim. Cm.	Ağırlık Weight Kg.	Paslanmaz Özelliği Stainless Steel Type	
	PA-VN7	-2/+8	700	72x85x213	78x91x228	171	304
	PA-VL7	-10/-22	700	72x85x213	78x91x228	181	304
	PA-BN7	-2/+8	700	72x85x213	78x91x228	171	430
	PA-BL7	-10/-22	700	72x85x213	78x91x228	181	430
	PA-VN7-G	-2/+8	700	72x85x213	78x91x228	178	304
	PA-VL7-G	-10/-22	700	72x85x213	78x91x228	191	304
	PA-BN7-G	-2/+8	700	72x85x213	78x91x228	178	430
	PA-BL7-G	-10/-22	700	72x85x213	78x91x228	191	430

EF: Bu modellerde energy efficiency kondenser fanı kullanılmaktadır. / These models have energy efficiency condenser fans.

Panel Dik Buzdolabı 2 Kapılı

Panel Vertical Refrigerator 2 Door



PA-VN14

62 Adet Raf Kapasitesi.
4,5 cm Aralıklı.
62 Unit Shelf Holder Capacity.
4,5 cm Spaced.

Option : 189 €

115 V / 60 Hz

KF



89€

Fanlı Kanopi
Canopy With Fan



Modüler
Panel Buzdolabı
Modular Panel

GN 2/1

Panel şeklinde nakliye %80'e varan avantaj.
40'lık konteynır / Tek kapılı dolap için.

When loaded as panels, ability to load up to
%80 more products.
40 feet container / One door refrigerator.



FRENOX
PROFESSIONAL REFRIGERATION

Special Line Series

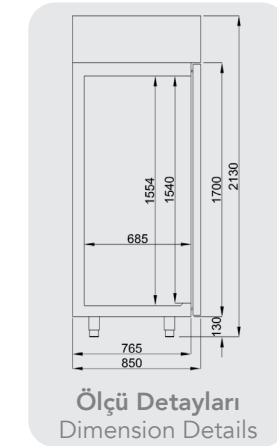

Ölçü Detayları
Dimension Details

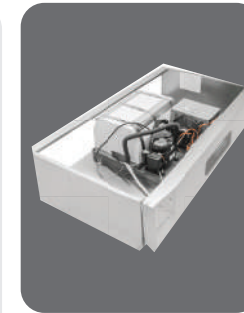

Monoblok
Soğutma Sistemi
Monoblock Cooling
Group



Ekstra Kuvvetli Dayanıklı
Fanlar Yüksek Hava Akışı
Strong Fans with maximum
air speed



Tek Kapıda %17, Çift
Kapıda %34 Fazla İç Hacim
More Storage Volume %17
in One Door, %34 in Two
Door Cabinet

Bilgi

- * Modüler Panel Şeklinde Montaj ve Söküm Kolaylığı
- * İç Derinlik: 65 Cm (GN 2/1 Kapasiteli)
- * 35-40 Kg/m3 Gazlı Çevre Dostu HCFC İçermeyen Poliüretan İzolasyon
- * Dijital Kumanda Paneli
- * Otomatik Su Buharlaştırma Sistemi
- * Elektrikli Otomatik Defrost
- * Yüksekliği Ayarlanabilir Paslanmaz Ayaklar
- * Kapı Açıldığında Otomatik İç Aydınlatma
- * Özel, Kapı Menteşe Sistemi
- * Temizlenebilir ve Sökülebilir Manyetik Kapı Contası
- * Dış Ortam Sıcaklığı: + 43°C & % 65 Nem

Info

- * Modular - Panel Shaped Assembly and Disassembly Facility
- * Inside Depth: 65 Cm (GN 2/1 Capacity)
- * 35-40 Kg/m3 Ecology Friendly HCFC Free Polyurethane Insulation
- * Digital Control Panel
- * Smart Defrost System
- * Automatic Water Evaporation System (Hot Gas)
- * Electrical Automatic Defrost
- * Stainless Steel Legs Adjustable For Height
- * Automatic Lighting Inside When Door is Open
- * Removable and Easy Cleaning Magnetic Gaskets
- * Ambient Temperature: + 43°C & % 65 Humidity

Kod Özellikleri

Available Codes

Raf Shelf 49 €

W Tekerlekli / Wheels 90 €

T Touch Dijital Touch Digital 217 €

V Görüntü Appearance 56 €

SE Görüntü Appearance 56 €

WP Su Geçirmez Dijital Water Proof Digital 137 €

BT Wi-Fi Dijital Wi-Fi Digital 418 €

60hz 220 V 60 hz 56 €

İzolasyon Kalınlığı Insulation Thickness	Raf Adedi Shelf Unit	Soğutma Gazı Cooling Gas	Voltaj Voltage	Enerji Sınıfı Energy Rating	Kapı Adedi Door Unit	Fiyat Price €	Model Models	Fiyat Price
80 mm	6	R134A	220 V / 50 Hz	E	2	4.867 €	PA-VN14-R290	4.839 €
80 mm	6	R404A	220 V / 50 Hz	E	2	6.005 €	PA-VL14-R290	5.977 €
80 mm	6	R134A	220 V / 50 Hz	E	2	4.231 €	PA-BN14-R290	4.204 €
80 mm	6	R404A	220 V / 50 Hz	E	2	5.005 €	PA-BL14-R290	4.978 €
80 mm	6	R134A	220 V / 50 Hz	E	2	5.983 €	PA-VN14-G-R290	5.955 €
80 mm	6	R404A	220 V / 50 Hz	E	2	7.794 €	PA-VL14-G-R290	7.766 €
80 mm	6	R134A	220 V / 50 Hz	E	2	5.315 €	PA-BN14-G-R290	5.289 €
80 mm	6	R404A	220 V / 50 Hz	E	2	7.350 €	PA-BL14-G-R290	7.324 €

Model Models	İç Sıcaklık Temperature °C	Brüt Hacim Gross volume Lt.	Ölçüler Dimensions Cm.	Paket Ölçüsü Packing Dim. Cm.	Ağırlık Weight Kg.	Paslanmaz Özelliği Stainless Steel Type
PA-VN14	-2/+8	1400	144x85x213	150x91x228	250	304
PA-VL14	-10/-22	1400	144x85x213	150x91x228	280	304
PA-BN14	-2/+8	1400	144x85x213	150x91x228	250	430
PA-BL14	-10/-22	1400	144x85x213	150x91x228	280	430
PA-VN14-G	-2/+8	1400	144x85x213	150x91x228	265	304
PA-VL14-G	-10/-22	1400	144x85x213	150x91x228	300	304
PA-BN14-G	-2/+8	1400	144x85x213	150x91x228	265	430
PA-BL14-G	-10/-22	1400	144x85x213	150x91x228	300	430

EF: Bu modellerde energy efficiency kondenser fanı kullanılmaktadır. / These models have energy efficiency condenser fans.

Soğuk Banket Arabası

Cold Banquet Trolley



SB1

Gastronom kaplar fiyata dahil değildir.

Gastronom cups are not included in the price.

GN 2/1

13 Adet Raf Kapasitesi.
6,1 cm Aralıklı.
13 Unit Shelf Holder Capacity.
6,1 cm Spaced.

Option : 189 €

115 V / 60 Hz



FRENOX
PROFESSIONAL REFRIGERATION

Special Line Series

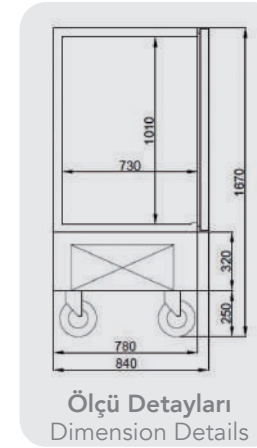

Ölçü Detayları
Dimension Details



SL1

Bilgi

- * İç Derinlik: 65 Cm (GN 2/1 Kapasiteli)
- * 35-40 Kg/m³ Gazlı Çevre Dostu HCFC İçermeyen Poliüretan İzolasyon
- * Dijital Kumanda Paneli
- * Otomatik Su Buharlaştırma Sistemi
- * Sıcak Gazlı Otomatik Defrost
- * Yüksekliği Ayarlanabilir Paslanmaz Ayaklar
- * Kapı Açıldığında Otomatik İç Aydınlatma
- * Özel, Kapı Menteşe Sistemi
- * Temizlenebilir ve Sökülebilir Manyetik Kapı Contası
- * Dış Ortam Sıcaklığı: + 43°C % 65 Nem

Info

- * Inside Depth: 65 Cm (GN 2/1 Capacity)
- * 35-40 Kg/m³ Ecology Friendly HCFC Free Polyurethane Insulation
- * Digital Control Panel
- * Automatic Water Evaporation System
- * Hot Gas Automatic Defrost
- * Stainless Steel Legs Adjustable For Height
- * Automatic Lighting Inside When Door is Open.
- * Special Door and Hinge Systems
- * Removable and Easy Cleaning Magnetic Gaskets
- * Ambient Temperature: + 43°C & % 65 Humidity

Kod Özellikleri

Available Codes

Raf ve Raf Kızağı
Shelf and Shelf Holder
49 €



T
Touch Dijital
Touch Digital
217 €

WP
Su Geçirmez Dijital
Water Proof Digital
137 €

BT
Wi-Fi Dijital
Wi-Fi Digital
418 €

L
Sol Kapı (Dikey)
Left Door (Upright)
30 €

60_{hz}
220 V
60 hz
56 €

Model Models	İç Sıcaklık Temperature °C	Brüt Hacim Gross volume Lt.	Ölçüler Dimensions Cm.	Paket Ölçüsü Packing Dim. Cm.	Ağırlık Weight Kg.	Paslanmaz Özelligi Stainless Steel Type
 SB1	-2/+8	12 Ad. GV 2/1	71x84x164	80x90x180	130	304
 SL1	-18/-20	12 Ad. Gn 2/1	71x84x164	80x90x180	135	304

İzolasyon Kalınlığı Insulation Thickness	Raf Adedi Shelf Unit	Soğutma Gazı Cooling Gas	Voltaj Voltage	Enerji Sınıfı Energy Rating	Kapı Adedi Door Unit	Fiyat Price €	Model Models	Fiyat Price
75 mm	-	R134A	220 V / 50 Hz	-	1	3.008 €	SB1-R290	2.980 €
75 mm	-	R404A	220 V / 50 Hz	-	1	3.589 €	SL1-R290	3.562 €

Monoblok Soğuk Oda

Monoblock Cold Room



FRENOX
PROFESSIONAL REFRIGERATION

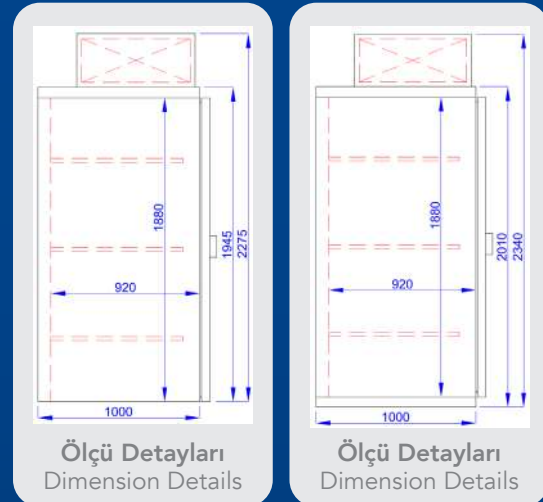

Option : 189 €

115 V / 60 Hz

CN100-WF
Tabansız
Without Floor

CN100

Ters Çevrilebilir Kapı Özelliği

Reversible Door Feature

CN100-WF



CN100



CN100-WF



CN100-WF

Special Line Series

Bilgi

- * 35-40 Kg/m³ Gazlı Çevre Dostu HCFC İçermeyen Poliüretan İzolasyon
- * Otomatik Su Buharlaştırma Sistemi
- * Özel, Kapı Menteşe Sistemi
- * Dış Ortam Sıcaklığı: + 32°C & % 50 Nem
- * Otomatik Defrost
- * Demonte Edilebilir Monoblok Soğutma Grubu
- * Demonte Edilebilir Panel Özelliği

Info

- * 35-40 Kg/m³ Ecology Friendly HCFC Free Polyurethane Insulation
- * Automatic Water Evaporation System
- * Special Hinges and Door System
- * Ambient Temperature: + 32°C & % 50 Humidity
- * Automatic Defrost
- * Removable Mono Block Cooling Unit
- * Removable Panels

Kod Özellikleri

Available Codes

60hz 220 V / 60 hz
56 €

WP Su Geçirmez Dijital Water Proof Digital
137 €

BT Wi-Fi Dijital Wi-Fi Digital
418 €

Model Models	İç Sıcaklık Temperature °C	Brüt Hacim Gross volume Lt.	Ölçüler Dimensions Cm.	Paket Ölçüsü Packing Dim. Cm.	Paslanmaz Özelliği Stainless Steel Type
 CN100	-2/+8	1000	100x100x234	110x120x254	Beyaz Boyalı Galvaniz / White Coated Galvanized
 CL100	-10/-22	1000	100x100x234	110x120x254	Beyaz Boyalı Galvaniz / White Coated Galvanized
 CN100-WF	-2/+8	1000	100x100x228	110x120x248	Beyaz Boyalı Galvaniz / White Coated Galvanized

İzolasyon Kalınlığı Insulation Thickness	Raf Adedi Shelf Unit	Soğutma Gazı Cooling Gas	Voltaaj Voltage	Kapı Adedi Door Unit	Fiyat Price €
80 mm	3	R290	220 V / 50 Hz	1	3.732 €
80 mm	3	R290	220 V / 50 Hz	1	4.737 €
80 mm	-	R290	220 V / 50 Hz	1	3.612 €

Dondurma Buzdolapları 1 Kapılı

Vertical Refrigerators 1 Door



BL8-EV-ICE

Option : 189 €



115 V / 60 Hz

28 Adet Raf Kapasitesi.
4,5 cm Aralıklı.
28 Unit Shelf Holder Capacity.
4,5 cm Spaced.

32 Adet 36x25x15 Dondurma Kabi Kapasiteli.
32 Units 36x25x15 Ice Cream Cup Capacity.



Special Line Series

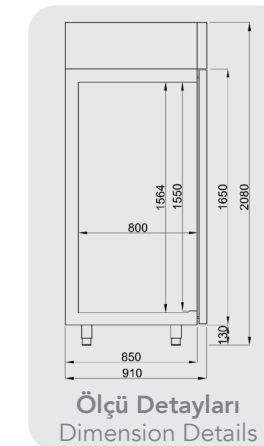

Ölçü Detayları
Dimension Details

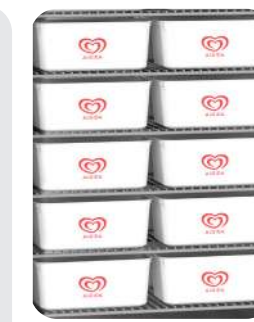

54 adet 36x17x12 Dondurma Kabi Kapasiteli
54 units 36x17x12 Ice Cream Cup Capacity



Değiştirilebilen Arasında Kir ve Bakteri Tutmayan Yüksek Manyetik Çekimli ÖZEL Conta
Special designed new gaskets. Can be removed, dirt-free

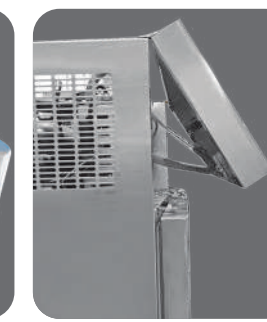

Açılabilir Kanopiyle Kolay Müdahale Olanağı
Front Cover Can be Opened For Easy Access

Kod Özellikleri
Available Codes

Raf ve Raf Kızağı
Shelf and Shelf Holder
49 €

W
Tekerlekli / Wheels
90 €

T
Touch Dijital
Touch Digital
217 €

V
Görüntü Apearence
56 €

SE
Görüntü Apearence
56 €

WP
Su Geçirmez Dijital
Water Proof Digital
137 €

BT
Wi-Fi Dijital
Wi-Fi Digital
418 €

L
Sol Kapı (Dikey)
Left Door (Upright)
30 €



60hz
220 V / 60 Hz
56 €

Bilgi

- * İç Derinlik: 80 cm
- * 35-40 Kg/m3 Gazlı Çevre Dostu HCFC İçermeyen Poliüretan İzolasyon
- * Otomatik Su Buharlaştırma Sistemi (Elektrik)
- * Yüksekliği Ayarlanabilir Paslanmaz Ayaklar
- * Kapı Açıldığında Otomatik İç Aydınlatma
- * Özel, Kapı Menteşe Sistemi
- * Temizlenebilir ve Sökülebilir Manyetik Kapı Contası
- * Dış Ortam Sıcaklığı: + 32°C & % 50 Nem

Info

- * Inside Depth: 80 cm
- * 35-40 Kg/m3 Ecology Friendly HCFC Free Polyurethane Insulation
- * Automatic Water Evaporation System (Electrical)
- * Stainless Steel Legs Adjustable For Height
- * Automatic Lighting Inside When Door is Open
- * Special Hinges and Door System
- * Removable and Easy Cleaning Magnetic Gaskets
- * Ambient Temperature: + 32°C & % 50 Humidity

Model Models	İç Sıcaklık Temperature °C	Brüt Hacim Gross volume Lt.	Ölçüler Dimensions Cm.	Paket Ölçüsü Packing Dim. Cm.	Ağırlık Weight Kg.	Paslanmaz Özelligi Stainless Steel Type	
	BL8-EV-ICE	-20/-28	785	82x92x208	90x100x220	176	430
	BL8-EV-ICE-G	-20/-25	785	82x92x208	90x100x220	188	430

İzolasyon Kalınlığı Insulation Thickness	Raf Adedi Shelf Unit	Soğutma Gazı Cooling Gas	Voltaj Voltage	Soğutma Gazı Cooling Gas	Enerji Sınıfı Energy Class	Fiyat Price €
60 mm	10	R290	220 V / 50 Hz	R290	E	4.239 €
60 mm	10	R290	220 V / 50 Hz	R290	E	4.909 €

EF: Bu modellerde energy efficiency kondenser fanı kullanılmaktadır. / These models have energy efficiency condenser fans.

Çikolata Saklama Buzdolabı

Chocolate Storage Refrigerator



VN9-CK

Maksimum Nem %65
Maximum Humidity %65

Option : 189 €

115 V / 60 Hz

Saklama
Derecesi
+10 / +14
Storage
Temperature
+10 / +14.

Özel Nem
Göstergeli
Kontrol Paneli
Special
Humidity
Control Panel



Special Line Series

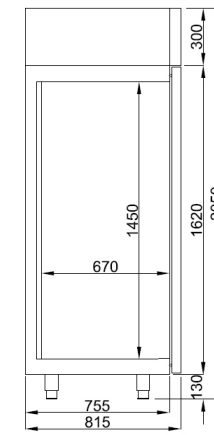

Değiştirilebilen Arasında
Kir ve Bakteri Tutmayan
Yüksek Manyetik Çekimli
ÖZEL Conta
Special designed new gaskets.
Can be removed, dirt-free



Açılabilir Kanopiyle
Kolay Müdahale Olanağı
Front Cover Can be
Opened For Easy Access

Kod Özellikleri
Available Codes

Raf ve Raf Kızağı
Shelf and
Shelf
Holder 49 €

W
Tekerlekli / Wheels 90 €

T
Touch Dijital
Touch Digital 217 €

V
Görüntü
Appearance 56 €

SE
Görüntü
Appearance 56 €

WP
Su Geçirmez Dijital
Water Proof Digital 137 €

BT
Wi-Fi Dijital
Wi-Fi Digital 418 €

L
Sol Kapı
(Dikey)
Left Door
(Upright) 30 €



60
220 V
60 hz 56 €

Bilgi

- * Çikolata Saklamak için İdeal Nem ve Sıcaklık Koşulları
- * İç Derinlik: 54 Adet
- * 35-40 Kg/m³ Gazlı Çevre Dostu HCFC İçermeyen Poliüretan İzolasyon
- * Otomatik Su Buharlaştırma Sistemi (Elektrik)
- * Yüksekliği Ayarlanabilir Paslanmaz Ayaklar
- * Kapı Açıldığında Otomatik İç Aydınlatma
- * Özel, Kapı Menteşe Sistemi
- * Temizlenebilir ve Sökülebilir Manyetik Kapı Contası
- * Dış Ortam Sıcaklığı: + 32°C & % 50 Nem

Info

- * Optimum Humidity and Temperature Conditions for Chocolate Storage
- * Inside Depth: 54 Units
- * 35-40 Kg/m³ Ecology Friendly HCFC Free Polyurethane Insulation
- * Automatic Water Evaporation System (Electrical)
- * Stainless Steel Legs Adjustable For Height
- * Automatic Lighting Inside When Door is Open
- * Special Hinges and Door System
- * Removable and Easy Cleaning Magnetic Gaskets
- * Ambient Temperature: + 32°C & % 50 Humidity

Model Models	İç Sıcaklık Temperature °C	Brüt Hacim Gross volume Lt.	Ölçüler Dimensions Cm.	Paket Ölçüsü Packing Dim. Cm.	Ağırlık Weight Kg.	Paslanmaz Özelligi Stainless Steel Type
	+10/+14 Max. %65 Hum.	700	70x81x205	80x85x220	155	304
	+10/+14 Max. %65 Hum.	700	70x81x205	80x85x220	163	304

İzolasyon Kalınlığı Insulation Thickness	Raf Adedi Shelf Unit	Soğutma Gazı Cooling Gas	Voltaj Voltage	Kapı Adedi Door Unit	Fiyat Price €
85 mm	3	R134	220V 50Hz	1	3.710 €
85 mm	3	R134	220V 50Hz	1	4.226 €

EF: Bu modellerde energy efficiency kondenser fanı kullanılmaktadır. / These models have energy efficiency condenser fans.

Dikey Buzdolapları İki Tarafta Kapılı

Vertical Refrigerators Pass Through

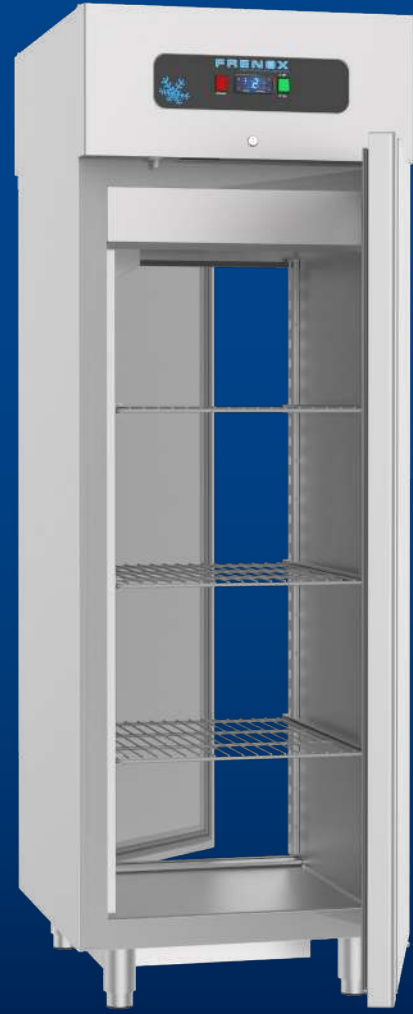

VN7-PAS

GN 2/1

Option : 189 €

115 V / 60 Hz

KF
89€
Fanlı Kanopi
Canopy With Fan

29 Adet Raf
Kapasitesi.
4,5 cm Aralıklı.
29 Unit Shelf
Holder Capacity.
4,5 cm Spaced.



FRENEX
PROFESSIONAL REFRIGERATION

Special Line Series

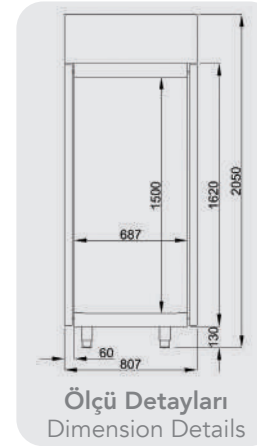

Ölçü Detayları
Dimension Details



Monoblok
Soğutma Sistemi
Monoblock Cooling
Group



Ekstra Kuvvetli Dayanıklı
Fanlar Yüksek Hava Akışı
Strong Fans with maximum
air speed

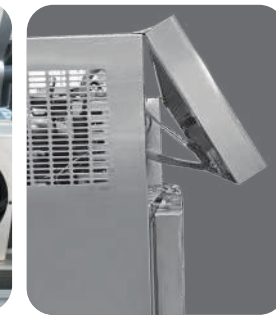

Açılabilir Kanopiyle
Kolay Müdahale Olanığı
Front Cover Can be
Opened For Easy Access

Bilgi

- * 35-40 Kg/m³ Çevre Dostu HCFC İçermeyen Poliüretan İzolasyon
- * Dijital Kumanda Paneli
- * Kilitli Kapı
- * Otomatik Su Buharlaştırma Sistemi
- * Otomatik Defrost
- * Özel Kapı ve Menteşe Sistemi
- * Temizlenebilir ve Sökülebilir Manyetik Kapı Contası
- * Dış Ortam Sıcaklığı + 43°C & % 65 Nem
- * İki Tarafta Kapı
- * Çift Taraftan Yükleme Yapabilme Özelliği

Info

- * 35-40 Kg/m³ Ecology Friendly HCFC Free Polyurethane Insulation
- * Digital Control Panel
- * Door Lock
- * Automatic Water Evaporation System
- * Automatic Defrost
- * Special Door and Hinge Systems
- * Removable and Easy Cleaning Magnetic Gasket
- * Ambient Temperature + 43°C & % 65 Nem
- * Doors Both Side
- * Possibility to Load From Both Sides

Kod Özellikleri

Available Codes

Raf ve Raf Kızağı
Shelf and
Shelf
Holder 49 €

W
Tekerlekli / Wheels 90 €

T
Touch Dijital
Touch Digital 217 €

SE
Görüntü
Appearance 56 €

V
Görüntü
Appearance 56 €





WP
Su Geçirmez Dijital
Water Proof Digital 137 €

-2
Yarım Kapı
Half Door 197 €

BT
Wi-Fi Dijital
Wi-Fi Digital 418 €

L
Sol Kapı
(Dikey)
Left Door
(Upright) 30 €

60_{hz}
220 V
60 hz 56 €

Model Models	İç Sıcaklık Temperature °C	Brüt Hacim Gross volume Lt.	Ölçüler Dimensions Cm.	Paket Ölçüsü Packing Dim. Cm.	Ağırlık Weight Kg.	Paslanmaz Özelligi Stainless Steel Type
 VN7-PAS	-2/+8	700	70x81x205	80x85x220	138	304
 VL7-PAS	-10/-20	700	70x81x205	80x85x220	143	304
 VN7-PAS-G	-2/+8	700	70x81x205	80x85x220	150	304
 VL7-PAS-G	-10/-20	700	70x81x205	80x85x220	158	304

İzolasyon Kalınlığı Insulation Thickness	Raf Adedi Shelf Unit	Soğutma Gazı Cooling Gas	Voltaj Voltage	Kapı Adedi Door Unit	Fiyat Price €	Model Models	Fiyat Price
60 mm	3	R134	220 V / 50 Hz	2	2.886 €	VN7-PAS-R290	2.859 €
60 mm	3	R404A	220 V / 50 Hz	2	3.353 €	VL7-PAS-R290	3.326 €
60 mm	3	R134	220 V / 50 Hz	2	3.773 €	VN7-PAS-G-R290	3.746 €
60 mm	3	R404A	220 V / 50 Hz	2	4.536 €	VL7-PAS-G-R290	4.508 €

Yatay Buzdolapları Ada Serisi

Counter Refrigerators Island Series

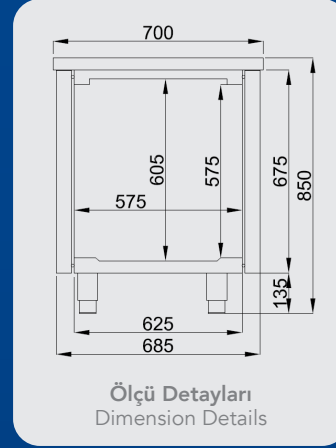
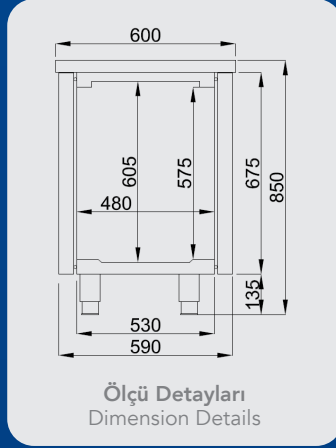

Option : 189 €

115 V / 60 Hz



CGN3-2G-DZ



Special Line Series



CGN2-2-DZ



CGN3-2-DZ

Bilgi

- * İç Derinlik: 53 Cm (GN 1/1 Kapasiteli)
- * 35-40 Kg/m³ Çevre Dostu HCFC İçermeyen Poliüretan İzolasyon
- * Dijital Kumanda Paneli
- * Elektrik Rezistanslı Otomatik Defrost
- * Yüksekliği Ayarlanabilir Paslanmaz Ayaklar
- * Özel Kapı ve Menteşe Sistemi
- * Temizlenebilir ve Sökülebilir Manyetik Kapı Contası
- * Dış Ortam Sıcaklığı + 43 °C & % 65 Nem
- * Dolabın İki tarafında Kapı & Çift Taraflı Çalışma İmkânı

Info

- * Inside Depth: 53 Cm (GN 1/1 Capacity)
- * 35-40 Kg/m³ Ecology Friendly HCFC Free Polyurethane Insulation
- * Digital Control Panel
- * Electrical Resistor Automatic Defrost
- * Stainless Steel Legs Adjustable for Height
- * Special Door and Hinge Systems
- * Removable and Easy Cleaning Magnetic Gasket
- * Ambient Temperature + 43 °C & % 65 Nem
- * Doors On Both Side of The Refrigerator
- * Possibility to Work From Both Sides

Kod Özellikleri

Available Codes

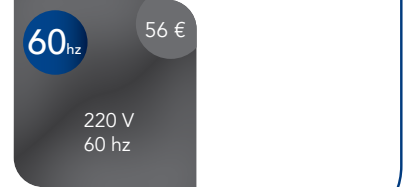
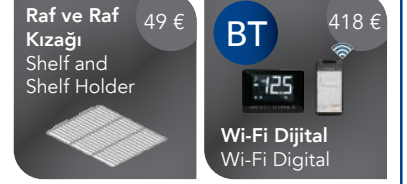

Model Models	İç Sıcaklık Temperature °C	Brüt Hacim Gross volume Lt.	Ölçüler Dimensions Cm.	Paket Ölçüsü Packing Dim. Cm.	Ağırlık Weight Kg.	Paslanmaz Özelliği Stainless Steel Type	
	CGN2-2G-DZ	-2/+8	281	140x70x85	150x80x100	145	304
	CGN2-2-DZ	-2/+8	281	140x70x85	150x80x100	140	304
	CGN3-2G-DZ	-2/+8	474	186,5x70x85	197x80x100	178	304
	CGN3-2-DZ	-2/+8	474	186,5x70x85	197x80x100	170	304
	CGN4-2G-DZ	-2/+8	632	233x70x85	243x80x100	210	304
	CGN4-2-DZ	-2/+8	632	233x70x85	243x80x100	200	304

G : Cam Kapı / G : Glass Door

İzolasyon Kalınlığı Insulation Thickness	Raf Adedi Shelf Unit	Soğutma Gazı Cooling Gas	Voltaj Voltage	Fiyat Price €	Model Models	Fiyat Price
50 mm	2	R134A	220 V / 50 Hz	4.512 €	CGN2-2G-DZ-R290	4.484 €
50 mm	2	R134A	220 V / 50 Hz	3.625 €	CGN2-2-DZ-R290	3.598 €
50 mm	3	R134A	220 V / 50 Hz	5.251 €	CGN3-2G-DZ-R290	5.223 €
50 mm	3	R134A	220 V / 50 Hz	3.921 €	CGN3-2-DZ-R290	3.893 €
50 mm	4	R134A	220 V / 50 Hz	6.581 €	CGN4-2G-DZ-R290	6.553 €
50 mm	4	R134A	220 V / 50 Hz	4.808 €	CGN4-2-DZ-R290	4.780 €

Krep Hazırlık Buzdolabı

Crepe Table Refrigerator

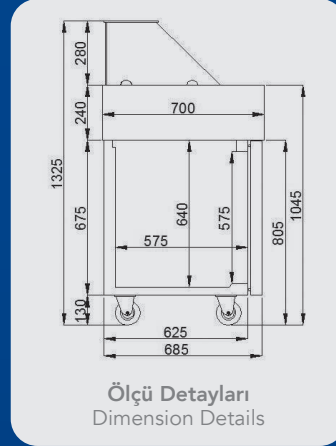

Ölçü Detayları
Dimension Details

Option : 189 €

115 V / 60 Hz



153€

90x48x20 cm
Ölçülerinde Krep
Makinesi Kullanılabilir

90x48x20 cm Crepe
Machine can be Used

Krep makinesi fiyata
dahil değildir.
Crepe machine is not
included in the price.

Gastronom kaplar fiyata
dahil değildir.

Gastronom cups are not
included in the price.

KMN2



FRENOX
PROFESSIONAL REFRIGERATION

Special Line Series

Çekmece Seçenekleri / Drawer Options

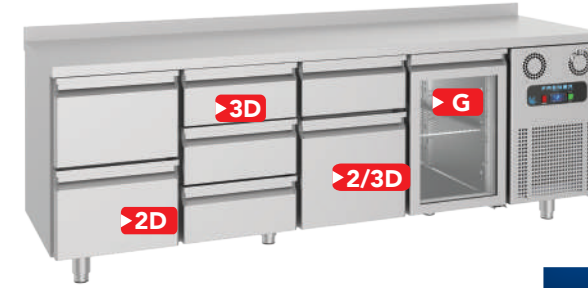

3D 1/3 Çekmece - 1/3 Drawers 597 €

2D 1/2 Çekmece - 1/2 Drawers 551 €

G Cam Kapı - Glass Door 228 €

2/3D 2/3 Çekmece - 2/3 Drawers 564 €

Cam Kapı Sadece Pozitif Kapılar İçindir
Glass Door Option is Only Available for Positive Doors

Bilgi

- * İç Derinlik: 53 Cm (GN 1/1 Kapasiteli)
- * 35-40 Kg/m³ Çevre Dostu HCFC İçermeyen Poliüretan İzolasyon
- * Dijital Kumanda Paneli
- * Elektrik Rezistanslı Otomatik Defrost
- * Yüksekliği Ayarlanabilir Paslanmaz Ayaklar
- * Özel Kapı ve Mentеше Sistemi
- * Temizlenebilir ve Sökülebilir Manyetik Kapı Contası
- * Dış Ortam Sıcaklığı + 43°C & % 65 Nem

Info

- * Inside Depth: 53 Cm (GN 1/1 Capacity
- * 35-40 Kg/m³ Ecology Friendly HCFC Free Polyurethane Insulation
- * Digital Control Panel
- * Electrical Resistor Automatic Defrost
- * Stainless Steel Legs Adjustable for Height
- * Special Door and Hinge Systems
- * Removable and Easy Cleaning Magnetic Gasket
- * Ambient Temperature + 43°C & % 65 Nem

Kod Özellikleri

Available Codes

Raf ve Raf Kızağı
Shelf and Shelf Holder

49 €

BT 418 €

Wi-Fi Dijital
Wi-Fi Digital

DKP 30 €

Dijital Koruma Plastiği
Digital Cover

W 90 €

Tekerlekli
Wheels

WP 137 €

Su Geçirmez Dijital
Water Proof Digital

60_{hz} 56 €

220 V
60 Hz

K 70 €/Unt

Kilitli Kapı
With Lock

Model Models	İç Sıcaklık Temperature °C	GN Kap GN Cup 1/6x100	Ölçüler Dimensions Cm.	Paket Ölçüsü Packing Dim. Cm.	Ağırlık Weight Kg.	Paslanmaz Özelliği Stainless Steel Type
 KMN2	-2/+8	9 Ad. GN 1/6x100	121x70x133	131x80x123	153	430

İzolasyon Kalınlığı Insulation Thickness	Raf Adedi Shelf Unit	Soğutma Gazı Cooling Gas	Voltaj Voltage	Fiyat Price €	Model Models	Fiyat Price €
50 mm	2	R134A	220 V / 50 Hz	3.301 €	KMN2-R290	3.275 €

Dikey Buzdolapları Roll-In Serisi

Vertical Refrigerators Roll-In Series



Modüler Panel
Buzdolabı
Modular Panel

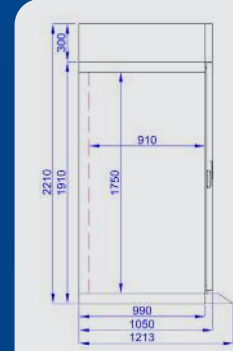

Ölçü Detayları
Dimension Details

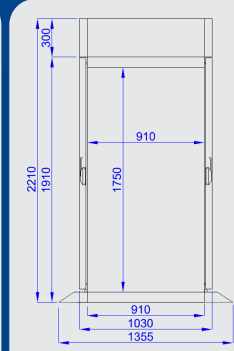

Ölçü Detayları
Dimension Details

Option : 189 €

2/1
Tepsi Arabası
Kapasiteli
2/1
Tray Trolley
Capacity

115 V / 60 Hz

GN 2/1

KF



89€

Fanlı Kanopi
Canopy With Fan

Tepsi sürme arabası fiyata dahil değildir.
Tray trolley is not included in the price.

PA-VN7-RO/2



FRENOX
PROFESSIONAL REFRIGERATION

Special Line Series



Monoblok Soğutma Sistemi
Monoblock Cooling Group



Ekstra Kuvvetli Dayanıklı Fanlar Yüksek Hava Akışı
Strong Fans with maximum air speed



Açılabilir Kanopiyle Kolay Müdahale Olanağı
Front Cover Can be Opened For Easy Access

WF Option: Tabansız , 8 cm düşük yükseklik (Sadece artı dolaplarda)
Without Floor, 8 Cm less height (Only in positive units)

Bilgi

- * İç Derinlik: 40x60 Tepsi Taşıma Arabası
- * Araba Yüksekliği Max. 145 Cm
- * 35-40 Kg/m³ Çevre Dostu HCFC İçermeyen Poliüretan İzolasyon
- * Dijital Kumanda Paneli
- * Kilitli Kapı
- * Otomatik Su Buharlaştırma Sistemi (Sıcak Gaz System)
- * Araba Sürmek İçin Özel Rampa
- * Özel Kapı ve Menteşe Sistemi
- * Temizlenebilir ve Sökülebilir Manyetik Kapı Contası
- * Dış Ortam Sıcaklığı + 43°C & % 65 Nem
- * RO/2 Serisi
- * İki Tarafta Kapı
- * Çift Taraftan Yükleme Yapabilme Özelliği

Info

- * Inside Depth: 40x60 Tray Trolley
- * Trolley Height Max. 145 Cm.
- * 35-40 Kg/m³ Ecology Friendly HCFC Free Polyurethane Insulation
- * Digital Control Panel
- * Door Lock
- * Automatic Water Evaporation System (Hot Gas System)
- * Special bottom to enter with the Rolling Car
- * Special Door and Hinge Systems
- * Removable and Easy Cleaning Magnetic Gasket
- * Ambient Temperature + 43°C & % 65 Nem
- * RO/2 Series
- * Doors Both Side
- * Possibility to Load From Both Sides

Kod Özellikleri

Available Codes

Tepsi Taşıma Arabası
Tray Trolley
1.296 €

W
Tekerlekli / Wheels
90 €

T
Touch Dijital
Touch Digital
217 €

WP
Su Geçirmez Dijital
Water Proof Digital
137 €

BT
Wi-Fi Dijital
Wi-Fi Digital
418 €

60hz
220 V
60 hz
56 €

Model Models	İç Sıcaklık Temperature °C	Brüt Hacim Gross volume Lt.	Ölçüler Dimensions Cm.	Paket Ölçüsü Packing Dim. Cm.	Ağırlık Weight Kg.	Paslanmaz Özellikler Stainless Steel Type
PA-VN7-RO	-2/+8	700	91x121x221	100x130x240	235	304
PA-VL7-RO	-10/-20	700	91x121x221	100x130x240	250	304

İzolasyon Kalınlığı Insulation Thickness	Raf Adedi Shelf Unit	Soğutma Gazı Cooling Gas	Voltaj Voltage	Kapı Adedi Door Unit	Fiyat Price €	Model Models	Fiyat Price
80 mm	-	R134A	220 V / 50 Hz	1	4.904 €	PA-VN7-RO-R290	4.877 €
80 mm	-	R404A	220 V / 50 Hz	1	5.495 €	PA-VL7-RO-R290	5.468 €

Dikey Buzdolapları Roll-In Serisi

Vertical Refrigerators Roll-In Series



PA-VN14-RO/2

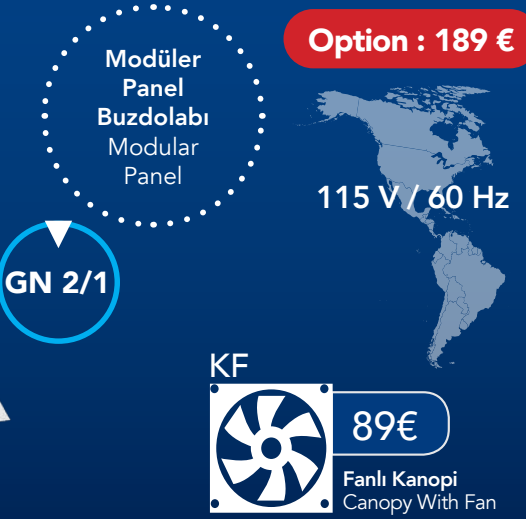
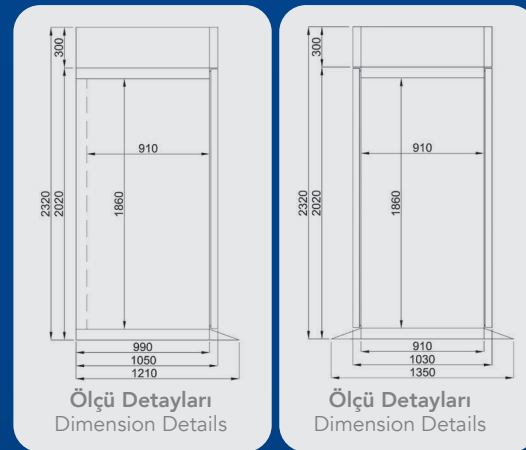

Tepsi sürme arabası fiyata dahil değildir.
Tray trolley is not included in the price.



Special Line Series



Monoblok Soğutma Sistemi
Monoblock Cooling Group



Ekstra Kuvvetli Dayanıklı Fanlar Yüksek Hava Akışı
Strong Fans with maximum air speed



Açılabilir Kanopiyle Kolay Müdahale Olanağı
Front Cover Can be Opened For Easy Access

WF Option: Tabansız , 8 cm düşük yükseklik (Sadece artı dolaplarda)
Without Floor, 8 Cm less height (Only in positive units)

Bilgi

- * İç Derinlik: 40x60 Tepsi Taşıma Arabası
- * Araba Yüksekliği Max. 145 Cm
- * 35-40 Kg/m³ Çevre Dostu HCFC İçermeyen Poliüretan İzolasyon
- * Dijital Kumanda Paneli
- * Kilitli Kapı
- * Otomatik Su Buharlaştırma Sistemi (Sıcak Gaz System)
- * Araba Sürmek İçin Özel Rampa
- * Özel Kapı ve Menteşe Sistemi
- * Temizlenebilir ve Sökülebilir Manyetik Kapı Contası
- * Dış Ortam Sıcaklığı + 43°C & % 65 Nem
- * RO/2 Serisi
- * İki Tarafta Kapı
- * Çift Taraftan Yükleme Yapılabilir Özelliği

Info

- * Inside Depth: 40x60 Tray Trolley
- * Trolley Height Max. 145 Cm.
- * 35-40 Kg/m³ Ecology Friendly HCFC Free Polyurethane Insulation
- * Digital Control Panel
- * Door Lock
- * Automatic Water Evaporation System (Hot Gas System)
- * Special bottom to enter with the Rolling Car
- * Special Door and Hinge Systems
- * Removable and Easy Cleaning Magnetic Gasket
- * Ambient Temperature + 43°C & % 65 Nem
- * RO/2 Series
- * Doors Both Side
- * Possibility to Load From Both Sides

Kod Özellikleri Available Codes

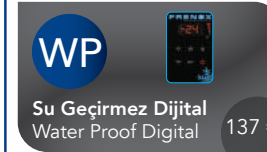

Model Models	İç Sıcaklık Temperature °C	Brüt Hacim Gross volume Lt.	Ölçüler Dimensions Cm.	Paket Ölçüsü Packing Dim. Cm.	Ağırlık Weight Kg.	Paslanmaz Özellik Steel Type
PA-VN14-RO	-2/+8	1400	182x121x221	190x130x240	360	304
PA-VL14-RO	-10/-20	1400	182x121x221	190x130x240	375	304

İzolasyon Kalınlığı Insulation Thickness	Raf Adedi Shelf Unit	Soğutma Gazı Cooling Gas	Voltaj Voltage	Kapı Adedi Door Unit	Fiyat Price €	Model Models	Fiyat Price
80 mm	-	R134A	220 V / 50 Hz	1	7.394 €	PA-VN14-RO-R290	7.367 €
80 mm	-	R404A	220 V / 50 Hz	1	8.451 €	PA-VL14-RO-R290	8.423 €

Çöp Buzdolabı - Mono Blok

Waste Refrigerator - Mono Block

304
Paslanmaz
304
Stainless Steel

* Back Side, Bottom Side, Upper Side,
Stainless Steel
* Arka, Alt, Üst
* Paslanmaz taban & Rampa
* Stainless Steel Floor & Ramp

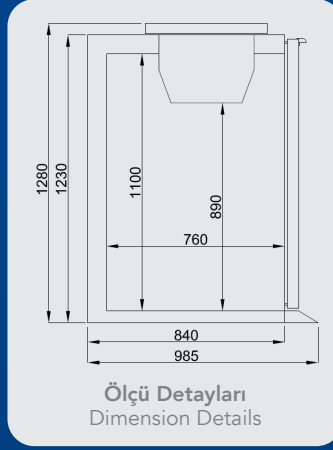

Option : 189 €

115 V / 60 Hz

Modüler
Panel
Buzdolabı
Modular
Panel



FRENOX
PROFESSIONAL REFRIGERATION

Special Line Series



PWT-1



PWT-2

Bilgi



- * İç Derinlik : 43 Cm / 53 Cm (GN 1/1 Kapasiteli)
- * 35-40 Kg/m³ Çevre Dostu HCFC İçermeyen Poliüretan İzolasyon
- * Dijital Kumanda Paneli
- * Elektrik Rezistanslı Otomatik Defrost
- * Özel Su Buharlaştırma Sistemi
- * Özel, Kapı Mentеше Sistemi
- * Temizlenebilir ve Sökülebilir Manyetik Kapı Contası
- * Dış Ortam Sıcaklığı: + 43°C & % 65 Nem

Info

- * Inside Depth: 43 Cm / 53 Cm (GN 1/1 Capacity)
- * 35-40 Kg/m³ Ecology Friendly HCFC Free Polyurethane Isolation
- * Digital Control Panel
- * Electrical Resistor Automatic Defrost
- * Special Water Evaporation
- * Special Hinges and Door System
- * Removable and Easy Cleaning Magnetic Gaskets
- * Ambient Temperature: + 43°C % 65 Humidity

Kod Özellikleri Available Codes



Model Models	İç Sıcaklık Temperature °C	240 Lt. Çöp Kovası 240 Lt. Waste Box	Ölçüler Dimensions Cm.	Paket Ölçüsü Packing Dim. Cm.	Ağırlık Weight Kg.	Paslanmaz Özelliği Stainless Steel Type
 PWT-1	-2/+8	1 Ad.	109x98x128	118x105x145	125	304
 PWT-2	-2/+8	2 Ad.	174x98x128	183x105x145	175	304

İzolasyon Kalınlığı Insulation Thickness	Raf Adedi Shelf Unit	Soğutma Gazı Cooling Gas	Voltaj Voltage	Fiyat Price €
50 mm	-	R134A	220 V / 50 Hz	3.552 €
50 mm	-	R134A	220 V / 50 Hz	4.216 €

Model Models	Fiyat Price
PWT-1-R290	3.525 €
PWT-2-R290	4.189 €



Pizza Buzdolapları 46x66 Tepsi Kapasitesi
Pizza Refrigerators 46x66 Tray Capacity

328-329

330-331

Pizza Buzdolapları 46x66 Tepsi Kapasitesi/Make-Up
Pizza Refrigerators 46x66 Tray Capacity/Make-Up



Pizza Buzdolapları 46x66 Tepsi Kapasitesi/Tezgah Tipi
Pizza Refrigerators 46x66 Tray Capacity/Counter Type

332-333

334-335

Yükseltilmiş Make Up Buzdolabı 46x66 Tepsi Kapasitesi
High Make Up Refrigerator 46x66 Tray Capacity



Pizza Buzdolapları 46x66 Tepsi Kapasitesi/Make-Up
Pizza Refrigerators 46x66 Tray Capacity/Make-Up

336-337



Pizza Buzdolapları 46x66 Tepsi Kapasitesi

Pizza Refrigerators 46x66 Tray Capacity

GN 1/3

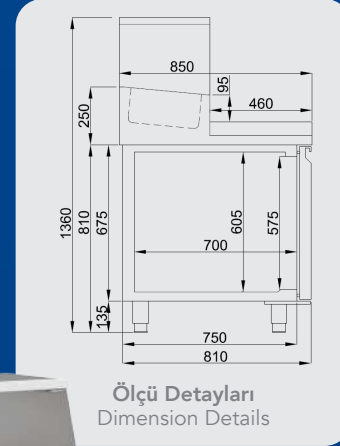

Option : 189 €

115 V / 60 Hz

8 Adet Raf Kapasitesi.
6 cm Aralıklı.
8 Unit Shelf Holder Capacity.
6 cm Spaced.

KF



153€

Fanlı Kanopi
Canopy With Fan

Sadece Raf Kızakları
Mevcuttur.
Only Shelf Rails are
Included.

46x66 Tepsiler fiyata
dahil değildir.
46x66 Trays are not
included in the price.

PIZ-237



FRENOX
PROFESSIONAL REFRIGERATION

46x66 America Line Series



PIZ 178

Kod Özellikleri
Available Codes

60_{hz}

56 €

W

90 €

220 V
60 hz

Tekerlekli
Wheels

DKP

30 €

T

217 €

Dijital Koruma Plastiği
Digital Cover

Touch Dijital
Touch Digital

WP

137 €

BT

418 €

Su Geçirmez Dijital
Water Proof Digital

Wi-Fi Dijital
Wi-Fi Digital

K

70 €/Unt



Kilitli Kapı
With Lock

Bilgi

- * İç Derinlik: 63 Cm (46x66 Tepsi Kapasiteli)
- * 35-40 Kg/m³ Çevre Dostu HCFC İçermeyen Poliüretan İzolasyon
- * Dijital Kumanda Paneli
- * Elektrik Rezistanslı Otomatik Defrost
- * Yüksekliği Ayarlanabilir Paslanmaz Ayaklar
- * Özel Kapı ve Menteşe Sistemi
- * Temizlenebilir ve Sökülebilir Manyetik Kapı Contası
- * Dış Ortam Sıcaklığı + 43 °C & % 65 Nem
- * GN 1/3x150 Kapasiteli Statik Soğutma Make-Up

Info

- * Inside Depth: 63 Cm (46x66 Tray Capacity)
- * 35-40 Kg/m³ Ecology Friendly HCFC Free Polyurethane Insulation
- * Digital Control Panel
- * Electrical Resistor Automatic Defrost
- * Stainless Steel Legs Adjustable for Height
- * Special Door and Hinge Systems
- * Removable and Easy Cleaning Magnetic Gasket
- * Ambient Temperature + 43 °C & % 65 Humidity
- * GN 1/3x150 Capacity Static Cooled Make-Up

Model Models	İç Sıcaklık Temperature °C	Brüt Hacim Gross volume Lt.	Ölçüler Dimensions Cm.	Paket Ölçüsü Packing Dim. Cm.	Ağırlık Weight Kg.	Paslanmaz Özelliği Stainless Steel Type
 PIZ-179	-2/+8	460	178x85x133	188x95x143	258	304
 PIZ-237	-2/+8	720	237x85x133	247x95x143	358	304

İzolasyon Kalınlığı Insulation Thickness	Raf Kızağı Takımı Shelf Rails Pair	Soğutma Gazı Cooling Gas	Voltaj Voltage	Fiyat Price €	Model Models	Fiyat Price €
50 mm	6 Shelf Rails	R134A	220 V / 50 Hz	6.678 €	PIZ-179-R290	6.650 €
50 mm	9 Shelf Rails	R134A	220 V / 50 Hz	8.155 €	PIZ-237-R290	8.128 €

Pizza Buzdolapları 46x66 Tepsi Kapasitesi/Make-Up

Pizza Refrigerators 46x66 Tray Capacity/Make-Up



46x66 America Line Series

GN 1/4

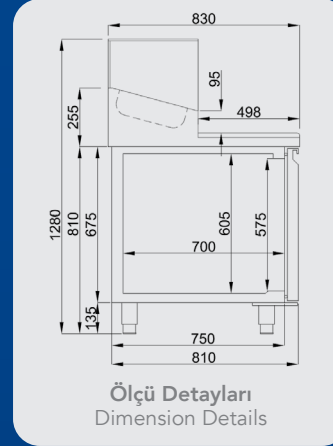

Ölçü Detayları
Dimension Details

Option : 189 €

115 V / 60 Hz

8 Adet Raf Kapasitesi.
6 cm Aralıklı.
8 Unit Shelf Holder Capacity.
6 cm Spaced.

KF



153€

Fanlı Kanopi
Canopy With Fan

Sadece Raf Kızakları
Mevcuttur.
Only Shelf Rails are
Included.

46x66 Tepsiler fiyata
dahil değildir.

46x66 Trays are not
included in the price.



PMN 223

Bilgi

- * İç Derinlik: 63 Cm (46x66 Tepsi Kapasiteli)
- * 35-40 Kg/m³ Çevre Dostu HCFC İçermeyen Poliüretan İzolasyon
- * Dijital Kumanda Paneli
- * Elektrik Rezistanslı Otomatik Defrost
- * Yüksekliği Ayarlanabilir Paslanmaz Ayaklar
- * Özel Kapı ve Menteşe Sistemi
- * Temizlenebilir ve Sökülebilir Manyetik Kapı Contası
- * Dış Ortam Sıcaklığı + 43 °C & % 65 Nem
- * GN 1/4x150 Kapasiteli Statik Soğutma Make-Up
- * Mermer Üst Tabla
- * Cam Kapak Make-Up Üstünde





Info

- * Inside Depth: 63 Cm (46x66 Tray Capacity)
- * 35-40 Kg/m³ Ecology Friendly HCFC Free Polyurethane Insulation
- * Digital Control Panel
- * Electrical Resistor Automatic Defrost
- * Stainless Steel Legs Adjustable for Height
- * Special Door and Hinge Systems
- * Removable and Easy Cleaning Magnetic Gasket
- * Ambient Temperature + 43 °C & % 65 Nem
- * GN 1/4x150 Capacity Static Cooled Make-Up
- * Marble Top Front Work Top
- * Glass Cover over Make-Up

Kod Özellikleri Available Codes



PMN-164

Model Models	İç Sıcaklık Temperature °C	Brüt Hacim Gross volume Lt.	Ölçüler Dimensions Cm.	Paket Ölçüsü Packing Dim. Cm.	Ağırlık Weight Kg.	Paslanmaz Özellikli Stainless Steel Type
 PMN-164	-2/+8	460	164x83x128	174x93x125	237	304
 BMN-164	-2/+8	460	164x83x128	174x93x125	237	430
 PMN-223	-2/+8	720	223x83x128	233x93x125	338	304
 BMN-223	-2/+8	720	223x83x128	233x93x125	338	430

İzolasyon Kalınlığı Insulation Thickness	Raf Kızağı Takımı Shelf Rails Pair	Soğutma Gazı Cooling Gas	Voltaj Voltage	Fiyat Price €	Model Models	Fiyat Price
50 mm	6 Shelf Rails	R134A	220 V / 50 Hz	4.262 €	PMN-164-R290	4.234 €
50 mm	6 Shelf Rails	R134A	220 V / 50 Hz	3.405 €	BMN-164-R290	3.379 €
50 mm	9 Shelf Rails	R134A	220 V / 50 Hz	4.913 €	PMN-223-R290	4.885 €
50 mm	9 Shelf Rails	R134A	220 V / 50 Hz	4.113 €	BMN-223-R290	4.087 €

Pizza Buzdolapları 46x66 Tepsi Kapasitesi/Tezgah Tipi

Pizza Refrigerators 46x66 Tray Capacity/Counter Type



46x66 America Line Series

8 Adet Raf Kapasitesi.
6 cm Aralıklı.
8 Unit Shelf Holder Capacity.
6 cm Spaced.

KF
153€
Fanlı Kanopi
Canopy With Fan

Derin Dondurucularda
Kanopide Fan Mevcuttur.

Deep Freezers Have Fan
On The Canopy

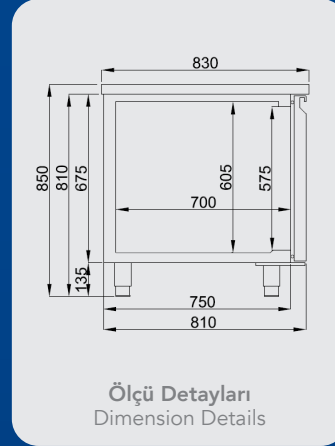

Ölçü Detayları
Dimension Details

Option : 189 €

115 V / 60 Hz

46x66 Tepsiler fiyata dahil değildir.

46x66 Trays are not included in the price.

Sadece Raf Kızakları Mevcuttur.

Only Shelf Rails are Included.



PN164

Bilgi

- * İç Derinlik: 63 Cm (46x66 Tepsi Kapasiteli)
- * 35-40 Kg/m³ Çevre Dostu HCFC İçermeyen Poliüretan İzolasyon
- * Dijital Kumanda Paneli
- * Elektrik Rezistanslı Otomatik Defrost
- * Yüksekliği Ayarlanabilir Paslanmaz Ayaklar
- * Özel Kapı ve Menteşe Sistemi
- * Temizlenebilir ve Sökülebilir Manyetik Kapı Contası
- * Dış Ortam Sıcaklığı + 43 °C & % 65 Nem

Info

- * Inside Depth: 63 Cm (46x66 Tray Capacity)
- * 35-40 Kg/m³ Ecology Friendly HCFC Free Polyurethane Insulation
- * Digital Control Panel
- * Electrical Resistor Automatic Defrost
- * Stainless Steel Legs Adjustable for Height
- * Special Door and Hinge Systems
- * Removable and Easy Cleaning Magnetic Gasket
- * Ambient Temperature + 43 °C & % 65 Nem

Kod Özellikleri Available Codes

WP 137 € Su Geçirmez Dijital Water Proof Digital	A 70 € 10 cm Yuvarlatılmış Sırtlı Tabla 10 cm Curved Splashback Work Top
DZ 0 € Düz Üst Tabla Straight Work Top	MR 2 Door 429 € 3 Door 531 € Mermer Üst Tabla Marble Work Top
GR 2 Door 858 € 3 Door 949 € Granit Üst Tabla Granite Work Top	F 2 Door 109 € 3 Door 139 € Üst Tablasız Without Work Top
PL 2 Door 780 € 3 Door 1014 € Polietilen Üst Tabla Polyethylene Work Top	T 217 € Touch Dijital Touch Digital
DKP 30 € Dijital Koruma Plastiği Digital Cover	L 30 € Sol Motor (Dikey) Left Motor (Upright)
BT 418 € Wi-Fi Dijital Wi-Fi Digital	W 90 € Tekerlekli Wheels
K 70 €/Unt Kilitli Kapı With Lock	60_{hz} 56 € 220 V 60 Hz



PN223

Model Models	İç Sıcaklık Temperature °C	Brüt Hacim Gross volume Lt.	Ölçüler Dimensions Cm.	Paket Ölçüsü Packing Dim. Cm.	Ağırlık Weight Kg.	Paslanmaz Özelliği Stainless Steel Type
	PN164	-2/+8	460	164x83x85	174x93x100	304
	BN164	-2/+8	460	164x83x85	174x93x100	430
	PL164	-10/-22	460	164x83x85	174x93x100	304
	BL164	-10/-22	460	164x83x85	174x93x100	430
	PN223	-2/+8	720	223x83x85	233x93x100	304
	BN223	-2/+8	720	223x83x85	233x93x100	430
	PL223	-10/-22	720	223x83x85	233x93x100	304
	BL223	-10/-22	720	223x83x85	233x93x100	430

İzolasyon Kalınlığı Insulation Thickness	Raf Kızağı Takımı Shelf Rails Pair	Soğutma Gazı Cooling Gas	Voltaj Voltage	Enerji Sınıfı Energy Rating	Fiyat Price €	Model Models	Fiyat Price
50 mm	6 Shelf Rails	R134A	220 V / 50 Hz	D	3.411 €	PN164-R290	3.384 €
50 mm	6 Shelf Rails	R134A	220 V / 50 Hz	D	3.110 €	BN164-R290	3.084 €
50 mm	6 Shelf Rails	R404A	220 V / 50 Hz	E	4.128 €	PL164-R290	4.100 €
50 mm	6 Shelf Rails	R404A	220 V / 50 Hz	E	3.794 €	BL164-R290	3.767 €
50 mm	9 Shelf Rails	R134A	220 V / 50 Hz	D	3.929 €	PN223-R290	3.902 €
50 mm	9 Shelf Rails	R134A	220 V / 50 Hz	D	3.604 €	BN223-R290	3.578 €
50 mm	9 Shelf Rails	R404A	220 V / 50 Hz	E	4.838 €	PL223-R290	4.810 €
50 mm	9 Shelf Rails	R404A	220 V / 50 Hz	E	4.470 €	BL223-R290	4.444 €

EF: Bu modellerde energy efficiency kondenser fanı kullanılmaktadır. / These models have energy efficiency condenser fans.

Yükseltilmiş Make Up Buzdolabı 46x66 Tepsi Kapasitesi

High Make Up Refrigerator 46x66 Tray Capacity



P223-YM-MR

Sadece Raf Kızakları
Mevcuttur.
Only Shelf Rails are
Included.

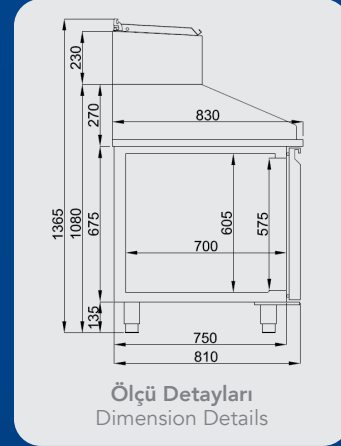

Ölçü Detayları
Dimension Details

Option : 189 €

115 V / 60 Hz

8 Adet Raf
Kapasitesi.
6 cm Aralıklı.
8 Unit Shelf
Holder Capacity.
6 cm Spaced.

KF



153€

Fanlı Kanopi
Canopy With Fan

Touch Dijital standart
üretiminde mevcut
değildir. Fiyat için yan
sayfaya bakınız.

Touch Digital is not
available in standart
production. Check the
options for the price.



FRENOX
PROFESSIONAL REFRIGERATION

46x66 America Line Series



P164-YM-MR

Bilgi

- * İç Derinlik: 63 Cm (46x66 Tepsi Kapasiteli)
- * 35-40 Kg/m³ Çevre Dostu HCFC İçermeyen Poliüretan İzolasyon
- * Dijital Kumanda Paneli
- * Elektrik Rezistanslı Otomatik Defrost
- * Yüksekliği Ayarlanabilir Paslanmaz Ayaklar
- * Özel Kapı ve Menteşe Sistemi
- * Temizlenebilir ve Sökülebilir Manyetik Kapı Contası
- * Dış Ortam Sıcaklığı + 43 °C & % 65 Nem

Info

- * Inside Depth: 63 Cm (46x66 Tray Capacity)
- * 35-40 Kg/m³ Ecology Friendly HCFC Free Polyurethane Insulation
- * Digital Control Panel
- * Electrical Resistor Automatic Defrost
- * Stainless Steel Legs Adjustable for Height
- * Special Door and Hinge Systems
- * Removable and Easy Cleaning Magnetic Gasket
- * Ambient Temperature + 43 °C & % 65 Nem

Kod Özellikleri Available Codes

WP 137 €



Su Geçirmez Dijital
Water Proof Digital

W 90 €



Tekerlekli
Wheels

DKP 30 €



Dijital Koruma Plastiği
Digital Cover

T 217 €



Touch Dijital
Touch Digital

K 70 €



Kilitli Kapı
With Lock

BT 418 €



Wi-Fi Dijital
Wi-Fi Digital

L 137 €

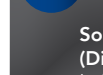

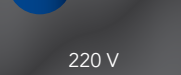

Sol Motor
(Dikey)
Left Motor
(Upright)

60_{hz} 54€



220 V
60 Hz

Model Models	İç Sıcaklık Temperature °C	Brüt Hacim Gross volume Lt.	Ölçüler Dimensions Cm.	Paket Ölçüsü Packing Dim. Cm.	Ağırlık Weight Kg.	Paslanmaz Özelliği Stainless Steel Type
 P164-YM-MR	-2/+8	9 Ad. GN 1/3x150	164x83x137	174x93x152	190	304
 P223-YM-MR	-2/+8	12 Ad. GN 1/3x150	223x83x137	233x93x152	230	304

İzolasyon Kalınlığı Insulation Thickness	Raf Kızağı Takımı Shelf Rails Pair	Soğutma Gazı Cooling Gas	Voltaj Voltage	Fiyat Price €	Model Models	Fiyat Price
50 mm	6 Shelf Rails	R134A	220 V / 50 Hz	4.313 €	P164-YM-MR-R290	4.286 €
50 mm	9 Shelf Rails	R134A	220 V / 50 Hz	5.308 €	P223-YM-MR-R290	5.280 €

Pizza Buzdolapları 46x66 Tepsi Kapasitesi/Make-Up

Pizza Refrigerators 46x66 Tray Capacity/Make-Up

KF



153€

Fanlı Kanopi
Canopy With Fan

GN 1/6

Option : 189 €

115 V / 60 Hz

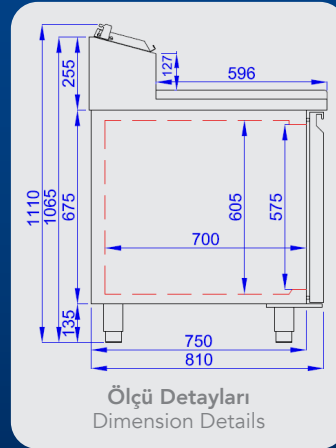

Ölçü Detayları
Dimension Details

PMP-223

Gastronom kaplar fiyata dahil değildir.
Gastronom cups are not included in the price.

46x66 Tepsiler fiyata dahil değildir.
46x66 Trays are not included in the price.

Sadece Raf Kızakları Mevcuttur.
Only Shelf Rails are Included.



FRENOX
PROFESSIONAL REFRIGERATION

46x66 America Line Series



PMP164-06-SC

Kod Özellikleri
Available Codes

60_{hz}

54 €

T

217 €

220 V
60 hz

Touch Dijital
Touch Digital

Bilgi

- * İç Derinlik: 63 Cm (46x66 Tepsi Kapasiteli)
- * 35-40 Kg/m³ Çevre Dostu HCFC İçermeyen Poliüretan İzolasyon
- * Dijital Kumanda Paneli
- * Elektrik Rezistanslı Otomatik Defrost
- * Yüksekliği Ayarlanabilir Paslanmaz Ayaklar
- * Özel Kapı ve Menteşe Sistemi
- * Temizlenebilir ve Sökülebilir Manyetik Kapı Contası
- * Dış Ortam Sıcaklığı + 43 °C & % 65 Nem
- * GN 1/6 x 150 Kapasiteli Statik Soğutma Make-Up
- * Mermer Üst Tabla
- * Paslanmaz Kapak Make-Up üstünde

Info

- * Inside Depth: 63 Cm (46x66 Tray Capacity)
- * 35-40 Kg/m³ Ecology Friendly HCFC Free Polyurethane Insulation
- * Digital Control Panel
- * Electrical Resistor Automatic Defrost
- * Stainless Steel Legs Adjustable for Height
- * Special Door and Hinge Systems
- * Removable and Easy Cleaning Magnetic Gasket
- * Ambient Temperature + 43 °C & % 65 Nem
- * GN 1/6 x 150 Capacity Static Cooled Make-Up
- * Marble Top Front Work Top
- * Stainless steel Cover over Make-UP

DKP





30 €

Dijital Koruma Plastiği
Digital Cover

K

70 €/Unt

Kilitli Kapı
With Lock

Model Models	İç Sıcaklık Temperature °C	Brüt Hacim Gross volume Lt.	Ölçüler Dimensions Cm.	Paket Ölçüsü Packing Dim. Cm.	Ağırlık Weight Kg.	Paslanmaz Özelliği Stainless Steel Type
 PMP-164	-2/+8	460	164x83x128	174x93x125	237	304
 BMP-164	-2/+8	460	164x83x128	174x93x125	237	430
 PMP-223	-2/+8	720	223x83x128	233x93x125	338	304
 BMP-223	-2/+8	720	223x83x128	233x93x125	338	430

İzolasyon Kalınlığı Insulation Thickness	Raf Kızağı Takımı Shelf Rails Pair	Soğutma Gazı Cooling Gas	Voltaj Voltage	Fiyat Price €	Model Models	Fiyat Price
50 mm	6 Shelf Rails	R134A	220 V / 50 Hz	4.092 €	PMP-164-R290	4.065 €
50 mm	6 Shelf Rails	R134A	220 V / 50 Hz	3.407 €	BMP-164-R290	3.380 €
50 mm	9 Shelf Rails	R134A	220 V / 50 Hz	4.904 €	PMP-223-R290	4.877 €
50 mm	9 Shelf Rails	R134A	220 V / 50 Hz	4.111 €	BMP-223-R290	4.085 €

WP

137 €

Su Geçirmez Dijital
Water Proof Digital

W

90 €

Tekerlekli
Wheels

BT

418 €

Wi-Fi Dijital
Wi-Fi Digital



Yeni Medical Line Serisi (-2/+8)
New Medical Line Series (-2/+8)

340-341

342-343

Yeni Medical Line Serisi (-25/-20)
New Medical Line Series (-25/-20)



Yeni Medical Line Serisi (-40/-38)
New Medical Line Series (-40/-38)

344-345

346-347

Aşı ve İlaç Dolapları
Drug and Vaccine Refrigerators



Medikal Buzdolapları - 400 Litre
Drug and Vaccine Refrigerators

348-349

350-351

Medikal Buzdolapları - 100 Litre
Medical Refrigerators - 100 Liters





New Medical Line Series

Yeni Medical Serisi

Double door and special cover system
Çift kapılı özel kapaklı sistem
Recording all alarms for two years
Tüm alarmları kaydetme kabiliyeti

Ability to monitor alarms online via internet
İnternet üzerinden online alarmları izleme
Ability to control all parameters online
Tüm parametreleri kontrol etme kabiliyeti



Model Models	İç Sıcaklık Temperature °C	Hacim Volume Lt.	Ölçüler Dimensions Cm.	Paket Ölçüsü Packing Dim. Cm.	Ağırlık Weight Kg.	Paslanmaz Özelliği Stainless Steel Type
 MD2-N	-2/+8	235	82x94x142	102x104x164	161	Inside : 304 Stainless Steel Outside : White Coated Galvanized
 MD3-N	-2/+8	355	82x94x175	102x104x194	201	Inside : 304 Stainless Steel Outside : White Coated Galvanized
 MD4-N	-2/+8	465	82x94x208	102x104x228	221	Inside : 304 Stainless Steel Outside : White Coated Galvanized



İzolasyon Kalınlığı Insulation Thickness	Raf Adedi Shelf Unit	Soğutma Gazı Cooling Gas	Voltaj Voltage	Kapı Adedi Door Unit	Fiyat Price
120 mm	2	R452A	220 V / 50 Hz	1	5.359 €
120 mm	3	R452A	220 V / 50 Hz	1	6.077 €
120 mm	4	R452A	220 V / 50 Hz	1	6.698 €

Battery Back-up

Yedek Pil

Electricity failure alarm

Elektrik kesintisi alarmı

Audio and display alarm

Sesli ve görüntülü alarm

Optional sound alarm for electricity failure

Elektrik kesintisi için isteğe bağlı sesli siren

High temperature alarm

Yüksek sıcaklık alarmı

Low temperature alarm

Düşük sıcaklık alarmı

Door open alarm

Açık kapı alarmı

Wi-fi module

Wi-fi modülü

Recording all alarms even the electricity is off

Elektrik kesilse bile tüm alarmları kaydetme özelliği



New Medical Line Series

Yeni Medical Serisi

Double door and special cover system
Çift kapılı özel kapaklı sistem
Recording all alarms for two years
Tüm alarmları kaydetme kabiliyeti

Ability to monitor alarms online via internet
İnternet üzerinden online alarmları izleme
Ability to control all parameters online
Tüm parametreleri kontrol etme kabiliyeti



MD4-L

Shelf Cover
Koruyucu Kapak



Model Models	İç Sıcaklık Temperature °C	Hacim Volume Lt.	Ölçüler Dimensions Cm.	Paket Ölçüsü Packing Dim. Cm.	Ağırlık Weight Kg.	Paslanmaz Özelliği Stainless Steel Type
MD2-L	-25/-20	235	82x94x142	102x104x164	180	Inside : 304 Stainless Steel Outside : White Coated Galvanized
MD3-L	-25/-20	355	82x94x175	102x104x194	214	Inside : 304 Stainless Steel Outside : White Coated Galvanized
MD4-L	-25/-20	465	82x94x208	102x104x228	238	Inside : 304 Stainless Steel Outside : White Coated Galvanized



Low
-25/-20 °C

Battery Back-up

Yedek Pil

Electricity failure alarm

Elektrik kesintisi alarmı

Audio and display alarm

Sesli ve görüntülü alarm

Optional sound alarm for electricity failure

Elektrik kesintisi için isteğe bağlı sesli siren

High temperature alarm

Yüksek sıcaklık alarmı

Low temperature alarm

Düşük sıcaklık alarmı

Door open alarm

Açık kapı alarmı

Wi-fi module

Wi-fi modülü

Recording all alarms even the electricity is off

Elektrik kesilse bile tüm alarmları kaydetme özelliği

İzolasyon Kalınlığı Insulation Thickness	Raf Adedi Shelf Unit	Soğutma Gazı Cooling Gas	Voltaj Voltage	Kapı Adedi Door Unit	Fiyat Price
120 mm	2	R452A	220 V / 50 Hz	1	6.215 €
120 mm	3	R452A	220 V / 50 Hz	1	7.044 €
120 mm	4	R452A	220 V / 50 Hz	1	7.969 €



New Medical Line Series



Yeni Medical Serisi

Double door and special cover system
Çift kapılı özel kapaklı sistem
Recording all alarms for two years
Tüm alarmları kaydetme kabiliyeti

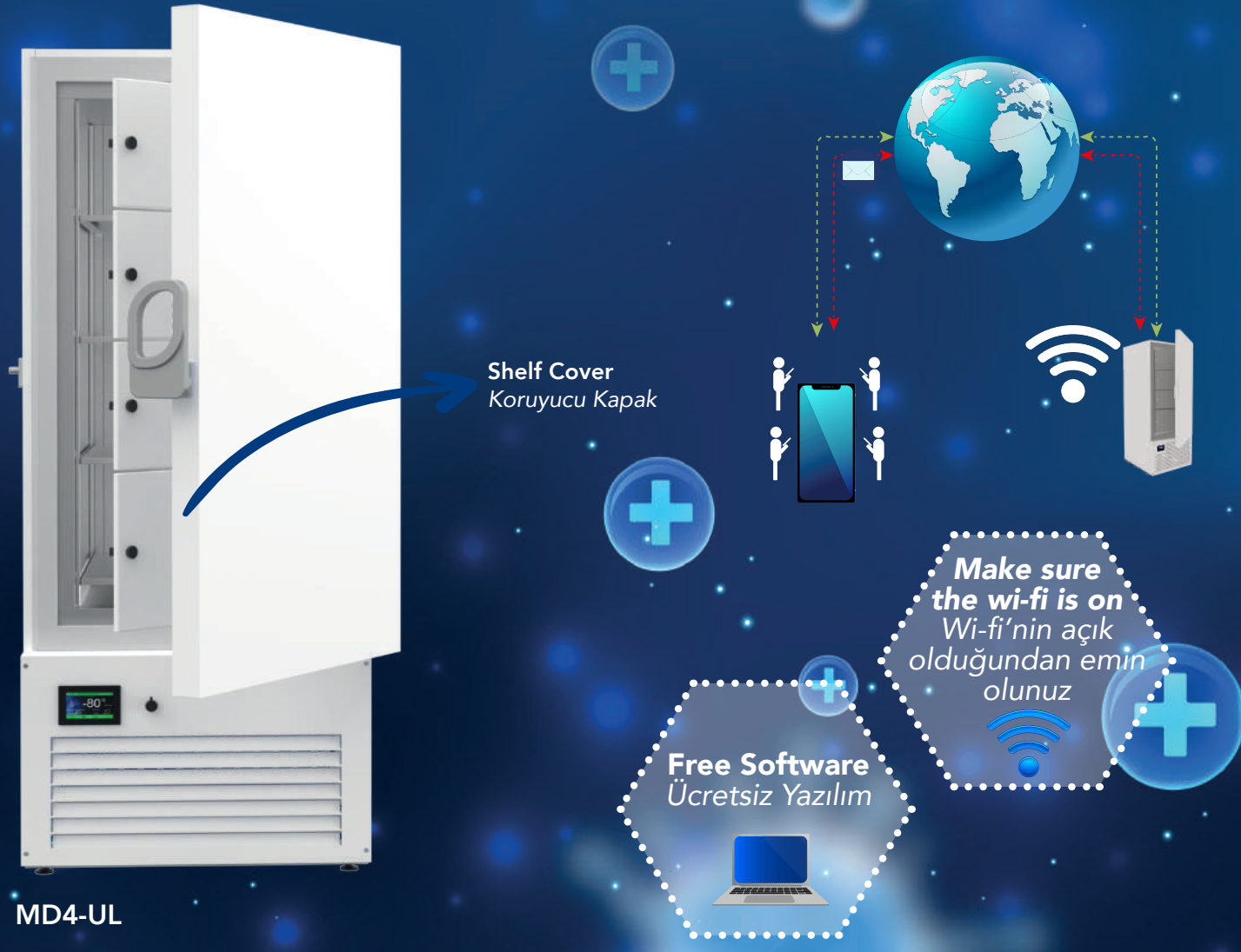
Ability to monitor alarms online via internet
İnternet üzerinden online alarmları izleme
Ability to control all parameters online
Tüm parametreleri kontrol etme kabiliyeti



MD4-UL

Model Models	İç Sıcaklık Temperature °C	Hacim Volume Lt.	Ölçüler Dimensions Cm.	Paket Ölçüsü Packing Dim. Cm.	Ağırlık Weight Kg.	Paslanmaz Özelliği Stainless Steel Type
 MD2-UL	-40/-35	235	82x94x142	102x104x164	200	Inside : 304 Stainless Steel Outside : White Coated Galvanized
 MD3-UL	-40/-35	355	82x94x175	102x104x194	224	Inside : 304 Stainless Steel Outside : White Coated Galvanized
 MD4-UL	-40/-35	465	82x94x208	102x104x228	250	Inside : 304 Stainless Steel Outside : White Coated Galvanized



Ultra Low
-40/-35 °C

Battery Back-up

Yedek Pil

Electricity failure alarm

Elektrik kesintisi alarmı

Audio and display alarm

Sesli ve görüntülü alarm

Optional sound alarm for electricity failure

Elektrik kesintisi için isteğe bağlı sesli siren

High temperature alarm

Yüksek sıcaklık alarmı

Low temperature alarm

Düşük sıcaklık alarmı

Door open alarm

Açık kapı alarmı

Wi-fi module

Wi-fi modülü

Recording all alarms even the electricity is off

Elektrik kesilse bile tüm alarmları kaydetme özelliği



Aşı ve İlaç Dolapları

Drug and Vaccine Refrigerators



MN-10

26 Adet Raf Kapasitesi.
5 cm Aralıklı.
26 Unit Shelf Holder Capacity.
5 cm Spaced.

Veri kaydetme özelliğine sahip
Data logger feature

Option : 189 €

115 V / 60 Hz

Battery Back-up

Yedek Pil

Recording all alarms even the electricity is off

Elektrik kesilse bile tüm alarmları kaydetme özelliği



FRENOX
PROFESSIONAL REFRIGERATION

Medical Line Series

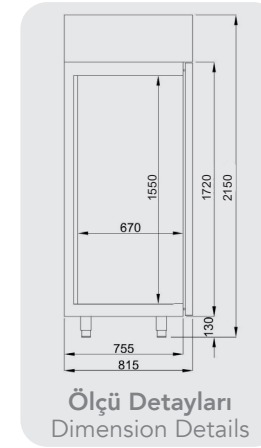

Ölçü Detayları
Dimension Details



MN20



Cam Kapılar Yarım Kapıda Geçerli Değildir
Glass Door is not Available in Half Door

Kod Özellikleri
Available Codes



Bilgi

- * İç Derinlik: 68,5 Cm
- * 35-40 Kg/m³ Çevre Dostu HCFC İçermeyen Poliüretan İzolasyon
- * 0,1°C Sıcaklık Okuma Ve Ayar Hassasiyeti
- * Sıcaklık, Güç Kesintisi, ve Kapı Alarmı
- * USB Sıcaklık Kaydedici
- * Alarm Çıkışı / H.A.C.C.P
- * Otomatik Su Buharlaştırma Sistemi
- * Özel Menteşe Sistemi
- * Temizlenebilir ve Sökülebilir Manyetik Kapı Contası
- * Dış Ortam Sıcaklığı + 43°C & % 65 Nem
- * Yedek Akülü

Info

- * Inside Depth: 46,5 Cm
- * 35-40 Kg/m³ Ecology Friendly HCFC Free Polyurethane Insulation
- * 0,1°C Temperature Setting and Reading Accuracy
- * Temperature, Power Failure and Door Alarm
- * USB Temperature Recorder
- * Alarm Output / H.A.C.C.P
- * Automatic Water Evaporation System
- * Special Hinges System
- * Removable and Easy Cleaning Magnetic Gasket
- * Ambient Temperature + 43°C & % 65 Nem
- * With Battery

Model Models	İç Sıcaklık Temperature °C	Brüt Hacim Gross volume Lt.	Ölçüler Dimensions Cm.	Paket Ölçüsü Packing Dim. Cm.	Ağırlık Weight Kg.	Paslanmaz Özelliği Stainless Steel Type
 MN10	0/+10	700	70x81x215	80x85x230	140	Outside : White Inside : 304
 ML10	-10/-25	700	70x81x215	80x85x230	140	Outside : White Inside : 304
 MN20	0/+10	1400	140x81x215	150x85x230	190	Outside : White Inside : 304
 ML20	-10/-25	1400	140x81x215	150x85x230	190	Outside : White Inside : 304

G : Cam Kapı / G : Glass Door

İzolasyon Kalınlığı Insulation Thickness	Raf Adedi Shelf Unit	Soğutma Gazı Cooling Gas	Voltaj Voltage	Kapı Adedi Door Unit	Fiyat Price €	Model Models	Fiyat Price
85 mm	3	R134A	220 V / 50 Hz	1	5.103 €	MN10-R290	5.076 €
85 mm	3	R404A	220 V / 50 Hz	1	6.309 €	ML10-R290	6.281 €
85 mm	6	R134A	220 V / 50 Hz	2	6.633 €	MN20-R290	6.606 €
85 mm	6	R404A	220 V / 50 Hz	2	9.781 €	ML20-R290	9.753 €

Medikal Buzdolapları - 400 Litre

Drug and Vaccine Refrigerators



MN4-G

Option : 189 €

115 V / 60 Hz

15 Adet Raf Kapasitesi.
2,5 cm Aralıklı.
15 Unit Shelf Holder Capacity.
2,5 cm Spaced.



Medical Line Series

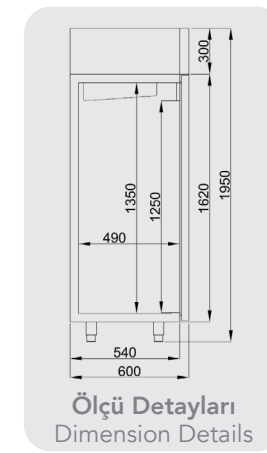

Ölçü Detayları
Dimension Details



MN4

Bilgi

- * İç Derinlik: 43 Cm / 53 Cm (GN 1/1 Kapasiteli)
- * 35-40 Kg/m³ Çevre Dostu HCFC İçermeyen Poliüretan İzolasyon
- * GN Kaplara Uygun Ölçü 2/1 ve 1/1
- * Ürünlerin Kurumaması için Dizayn Edilmiş Özel Soğutma Sistemi
- * Dijital Kumanda Paneli
- * Sıcak Gazlı Otomatik Defrost
- * Yüksekliği Ayarlanabilir Paslanmaz Ayaklar
- * Özel, Kapı Mentеше Sistemi
- * Temizlenebilir ve Sökülebilir Manyetik Kapı Contası
- * Dış Ortam Sıcaklığı: + 32°C & % 65 Nem
- * Otomatik Su Buharlaştırma Sistemi

Info

- * Inside Depth: 43 Cm / 53 Cm (GN 1/1 Capacity)
- * 35-40 Kg/m³ Ecology Friendly HCFC Free Polyurethane Insulation
- * Suitable for GN Cups 2/1 & 1/1
- * Special Design Cooling System to Prevent Drying of the Products
- * Digital Control Panel
- * Hot Gas Automatic Defrost
- * Stainless Steel Legs Adjustable For Height
- * Special Door and Hinge Systems
- * Removable and Easy Cleaning Magnetic Gaskets
- * Ambient Temperature: + 32°C & % 65 Humidity
- * Automatic Water Evaporation System

Kod Özellikleri

Available Codes

Raf ve Raf Kızağı
Shelf and Shelf Holder 49 €

W
Tekerlekli / Wheels 90 €

T
Touch Dijital
Touch Digital 217 €





WP
Su Geçirmez Dijital
Water Proof Digital 137 €

-2
Yarım Kapı
Half Door 197 €

BT
Wi-Fi Dijital
Wi-Fi Digital 418 €

L
Sol Kapı (Dikey)
Left Door (Upright) 418 €

60hz
220 V / 60 Hz 54 €

Model Models	İç Sıcaklık Temperature °C	Brüt Hacim Gross volume Lt.	Ölçüler Dimensions Cm.	Paket Ölçüsü Packing Dim. Cm.	Ağırlık Weight Kg.	Paslanmaz Özelliği Stainless Steel Type	
	MN4	0/+10	400	60x60x195	70x70x210	75	Outside : White Inside : 304
	ML4	-10/-22	400	60x60x195	70x70x210	75	Outside : White Inside : 304
	MN4-G	0/+10	400	60x60x195	70x70x210	75	Outside : White Inside : 304
	ML4-G	-10/-22	400	60x60x195	70x70x210	75	Outside : White Inside : 304

İzolasyon Kalınlığı Insulation Thickness	Raf Adedi Shelf Unit	Soğutma Gazı Cooling Gas	Voltaj Voltage	Kapı Adedi Door Unit	Fiyat Price €	Model Models	Fiyat Price
50 mm	3	R134A	220 V / 50 Hz	1	2.148 €	MN4-R290	2.120 €
50 mm	3	R404A	220 V / 50 Hz	1	2.614 €	ML4-R290	2.620 €
50 mm	3	R134A	220 V / 50 Hz	1	2.591 €	MN4-G-R290	2.563 €
50 mm	3	R404A	220 V / 50 Hz	1	3.131 €	ML4-G-R290	3.103 €

Medikal Buzdolapları - 100 Litre

Medical Refrigerators - 100 Liters



MSN1

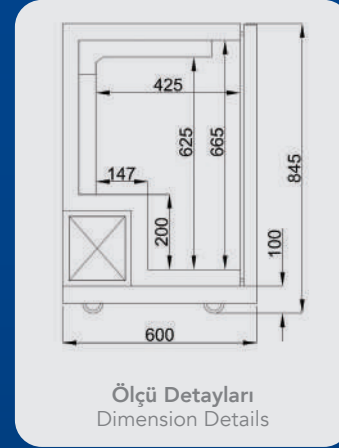

Option : 189 €

115 V / 60 Hz



Medical Line Series



MSN1-G

Kod Özellikleri
Available Codes





Bilgi

- * 35-40 Kg/m³ Çevre Dostu HCFC İçermeyen Poliüretan İzolasyon
- * Fanlı Soğutma
- * Dijital Termometre & Termostat
- * Otomatik Defrost
- * Yüksekliği Ayarlanabilir Ayaklar
- * Özel, Kapı Menteşe Sistemi
- * Temizlenebilir ve Sökülebilir Manyetik Kapı Contası
- * Plastik Kaplı Çelik Raf
- * Dış Ortam Sıcaklığı: + 43°C

Info

- * 35-40 Kg/m³ Ecology Friendly HCFC Free Polyurethane İsolasyon
- * Fan Cooling
- * Digital Thermometer & Thermostat
- * Automatic Defrost
- * Legs Adjustable For Height
- * Special Door and Hinge Systems
- * Removable and Easy Cleaning Magnetic Gaskets
- * Plastic Coated Steel Shelf
- * Ambient Temperature: + 43°C

Model Models	İç Sıcaklık Temperature °C	Brüt Hacim Gross volume Lt.	Ölçüler Dimensions Cm.	Paket Ölçüsü Packing Dim. Cm.	Ağırlık Weight Kg.	Paslanmaz Özelliği Stainless Steel Type
 MSN1-G	-2/+8	110	60x60x84,5	65x65x103	53	Outside : White Inside : 304
 MSN1	-2/+8	110	60x60x84,5	65x65x103	50	Outside : White Inside : 304
 MSL1	-20/-25	110	60x60x84,5	65x65x103	65	Outside : White Inside : 304

İzolasyon Kalınlığı Insulation Thickness	Raf Adedi Shelf Unit	Soğutma Gazı Cooling Gas	Voltaj Voltage	Fiyat Price €
50 mm	1	R290	220 V / 50 Hz	1.972 €
50 mm	1	R290	220 V / 50 Hz	1.677 €
50 mm	1	R290	220 V / 50 Hz	1.847 €

Modüler Soğuk Oda



Modular Cold Rooms



Ters
Çevrilebilir
Kapı
Özelliği

Reversible
Door
Feature

CR1212201-SS

430
Paslanmaz
430
Stainless
Steel

Ters
Çevrilebilir
Kapı
Özelliği

Reversible
Door
Feature

CR1215201

Beyaz Boyalı
Galvaniz
White Painted
Galvanize

Bilgi

- * Frenox 150'den fazla farklı ölçülerde ve kalınlıklarda ufak modüler oda üretimi yapabilir.
- * Ürünler 80mm veya 120mm' lik panel kalınlığı ile istenilen ölçülerde ve ısılarda üretilmektedir.
- * Bütün odalarımız modüler sistemde sökülebilir ve montaj edilebilmektedir.
- * Odaların en ufağı 1,8m³ ten başlayarak, 18,1m³ büyüklüğe kadar çıkabilmektedir.
- * İç ve Dış cepheler beyaz boyalı galvaniz ile hijyen kurallarına en uygun şekilde üretilmektedir.
- * Bütün izolasyon CFC free yüksek basınç Poliüretan izolasyon ile sağlanmaktadır.
- * Kolay açılabilir ve kapanabilir kilit sistemi ile hızlı montaj yapılabilmektedir.
- * Tabanlar 304 kalite paslanmaz kaymaz özel saçtan imal edilebilmektedir.

Info

- * FRENEX produce a range of more than 150 standard models of Mini Coldrooms.
- * The panels thickness is 80mm or 120mm Temperature range is 0 / +8 ; 10 / -25 C
- * All Rooms are modular (meaning that it could be easily installed and separated).
- * The range of models includes mini coldrooms from 1.8m³ to 18.1m³ of capacity.
- * The internal and external finish products are realized with white painted galvanized
- * The insulation of modular panels is with high density polyurethane, which is HCFC free.
- * Quickly and easily assemble due to the integral locking system.
- * The floor is anti-slip Stainless steel AISI 304.



Özellikler

- * 80mm veya 120mm Panel Kalınlığı
- * 42Kg/m³ densite poliüretan izolasyon.
- * Modüler paneller - Kolay Montaj ve ayrılabilme
- * 3 Panel ölçüsü - 300/600/900 ve köşe bölümü 15x45/45x45/45x60/15x60
- * üç yükseklik 2010/2200/2400, mevcut yerde en yüksek verim
- * İki taraflı kilitleme sistemi, dişi-erkek; mükemmel birleşim, civatasız silikonsuz montaj.
- * Tabansız oda seçeneği, arabaların kolay girişi, çıkışı.
- * Yuvarlatılmış köşeler, Özel paslanmaz zemin.
- * Contalı ve kolay ısıtmalı kapı. Mükemmel kapanım.
- * Soğutma bölümünün farklı yerlere yerleştirilebilme özelliği.
- * +43 derece ortam sıcaklığında çalışma



Info

- * 80mm or 120mm panel thickness
- * 42kg / m³ density polyurethane insulation.
- * Modular panels - easily assembled and separated
- * 3 panels size, 300/600/900 and corner section 15x45/45x45/45x60/15x60
- * 3 heights 2010/2200/2400, maximum capacity in present floor
- * two-side locking system, female-male; perfect combination, installation without any bolt or silicone.
- * Rounded corners and special stainless steel for the floor.
- * Door with gasket and heater easily.
- * Cooling section unit can be positioned anywhere
- * 43 degree ambient working temperatures.



Kurmalı Kilit Sistem / Winding Lock System



Zemin Panelleri / Floor Panels

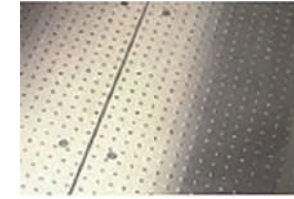

Standart Üretimimiz üst yüzeyi 1,0mm kalınlığında özel kaymaz paslanmaz sac, alt yüzeyi galvaniz saç arası 42 dansite poliüretan enjekte edilmiş panellerdir. İsteğe Bağlı olarak Kaymaz, kir tutmaz boncuklu paslanmaz zemin kullanılabilir.

Our production standard for top surface is 1,0mm special antisliding stainless steels, lower surface is galvanized sheet panels which 42 density polyurethane are injected. Optionally non-slip, dirt repellent beaded stainless floor available.

Köşe Panelleri / Corner Panels



Kolay montaj edilebilir. Fireleri ortadan kaldırma

Easy installation. Elimination of wastage



Opsiyonlar / Options

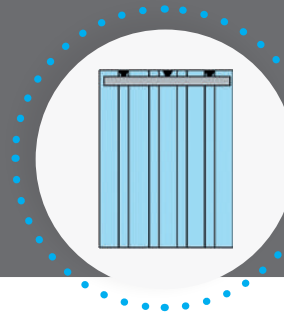

Şeffaf Perde
Strip Curtain

Fiyat / Price 189 €



Ekstra Güç Prizi
Extra Power Outlet

Fiyat / Price 130 €



Plastik Raf
Plastic Shelves

Plastik raf için
bkz sf : 244-245

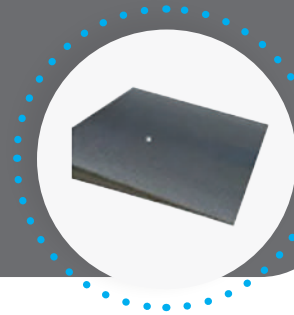

Rampa
Ride-in Panel

Fiyat / Price 376 €

Panel Opsiyonları / Panel Option

430 Paslanmaz Sac
430 Stainless Steels Panels

Beyaz Boyalı Galvaniz
White Painted Galvanize
(standart)

Gri / Grey

Siyah / Black

80 mm Oda Paneli / 80 mm Room Panel

Model	Hacim Volume	Dış Ölçüler External Dimensions			Net Kapı Ölçüsü Net Door Dimensions		360 mm Raflar 360 mm Shelves	460 mm Raflar 460 mm Shelves	Tabansız Oda Fiyatı Price Without Floor	İç 430, Dış 430 Paslanmaz Inside 430, Outside 430 Stainless Steel	Fiyat Price
		W	D	H	W	H					
CR1212201	2,0	1200	1200	2010	580	1845	395 €	403 €	1.828 €	2.808 €	1.966 €
CR1215201	2,6	1200	1500	2010	580	1845	395 €	403 €	2.281 €	3.482 €	2.453 €
CR1218201	3,1	1200	1800	2010	580	1845	767 €	754 €	2.459 €	3.777 €	2.643 €
CR1221201	3,7	1200	2100	2010	580	1845	806 €	798 €	2.531 €	4.183 €	2.928 €
CR1224201	4,3	1200	2400	2010	580	1845	832 €	824 €	2.791 €	4.516 €	3.160 €
CR1227201	5,1	1200	2700	2010	580	1845	1.071 €	1.062 €	3.087 €	4.744 €	3.320 €
CR1230201	5,4	1200	3000	2010	580	1845	1.127 €	1.123 €	3.341 €	5.134 €	3.593 €
CR1212220	2,2	1200	1200	2200	580	1845	395 €	403 €	1.890 €	3.207 €	2.100 €
CR1215220	2,8	1200	1500	2200	580	1845	395 €	403 €	2.421 €	3.974 €	2.602 €
CR1218220	3,5	1200	1800	2200	580	1845	767 €	754 €	2.629 €	4.315 €	2.825 €
CR1221220	4,1	1200	2100	2200	580	1845	806 €	798 €	2.531 €	4.729 €	3.097 €
CR1224220	4,8	1200	2400	2200	580	1845	832 €	824 €	3.077 €	5.051 €	3.310 €
CR1227220	5,4	1200	2700	2200	580	1845	1.071 €	1.062 €	3.448 €	5.680 €	3.708 €
CR1230220	6,0	1200	3000	2200	580	1845	1.127 €	1.123 €	3.669 €	6.044 €	3.948 €
CR1212240	2,4	1200	1200	2400	580	1845	395 €	403 €	2.150 €	3.532 €	2.312 €
CR1215240	3,1	1200	1500	2400	580	1845	395 €	403 €	2.620 €	4.305 €	2.817 €
CR1218240	3,8	1200	1800	2400	580	1845	767 €	754 €	2.768 €	4.541 €	2.977 €
CR1221240	4,5	1200	2100	2400	580	1845	806 €	798 €	3.797 €	5.262 €	3.434 €
CR1224240	5,2	1200	2400	2400	580	1845	832 €	824 €	3.410 €	5.617 €	3.668 €
CR1227240	5,9	1200	2700	2400	580	1845	1.071 €	1.062 €	3.892 €	6.435 €	4.187 €
CR1230240	6,6	1200	3000	2400	580	1845	1.127 €	1.123 €	4.102 €	6.791 €	4.412 €
CR1512201	2,6	1500	1200	2010	700	1845	434 €	442 €	2.281 €	3.505 €	2.453 €
CR1515201	3,5	1500	1500	2010	700	1845	434 €	442 €	2.596 €	3.988 €	2.791 €
CR1518201	4	1500	1800	2010	700	1845	806 €	802 €	2.620 €	4.026 €	2.817 €
CR1521201	4,8	1500	2100	2010	700	1845	841 €	837 €	2.922 €	4.471 €	3.130 €
CR1524201	5,5	1500	2400	2010	700	1845	910 €	902 €	3.188 €	4.900 €	3.429 €
CR1527201	6,3	1500	2700	2010	700	1845	1.127 €	1.119 €	3.571 €	5.488 €	3.841 €
CR1530201	7	1500	3000	2010	700	1845	1.215 €	1.196 €	3.731 €	5.735 €	4.014 €
CR1512220	2,8	1500	1200	2200	700	1845	434 €	442 €	2.410 €	3.958 €	2.592 €
CR1515220	3,7	1500	1500	2200	700	1845	434 €	442 €	2.843 €	4.669 €	3.057 €
CR1518220	4,5	1500	1800	2200	700	1845	806 €	802 €	2.929 €	4.811 €	3.150 €
CR1521220	5,3	1500	2100	2200	700	1845	841 €	837 €	3.349 €	5.501 €	3.602 €
CR1524220	6,1	1500	2400	2200	700	1845	910 €	902 €	3.571 €	5.866 €	3.841 €
CR1527220	6,9	1500	2700	2200	700	1845	1.127 €	1.119 €	3.991 €	6.556 €	4.293 €
CR1530220	7,8	1500	3000	2200	700	1845	1.215 €	1.196 €	4.177 €	6.850 €	4.492 €
CR1512240	3,2	1500	1200	2400	700	1845	434 €	442 €	2.620 €	4.303 €	2.817 €
CR1515240	4,1	1500	1500	2400	700	1845	434 €	442 €	3.053 €	5.014 €	3.283 €
CR1518240	4,9	1500	1800	2400	700	1845	806 €	802 €	3.287 €	5.400 €	3.535 €
CR1521240	5,8	1500	2100	2400	700	1845	841 €	837 €	3.731 €	6.129 €	4.014 €
CR1524240	6,7	1500	2400	2400	700	1845	910 €	902 €	4.062 €	6.677 €	4.373 €
CR1527240	7,6	1500	2700	2400	700	1845	1.127 €	1.119 €	4.473 €	7.348 €	4.811 €
CR1530240	8,5	1500	3000	2400	700	1845	1.215 €	1.196 €	4.519 €	7.504 €	4.837 €

Model	Hacim Volume	Dış Ölçüler External Dimensions			Net Kapı Ölçüsü Net Door Dimensions		360 mm Raflar 360 mm Shelves	460 mm Raflar 460 mm Shelves	Tabansız Oda Fiyatı Price Without Floor	İç 430, Dış 430 Paslanmaz Inside 430, Outside 430 Stainless Steel	Fiyat Price
		W	D	H	W	H					
CR1812201	3,1	1800	1200	2010	700	1845	833 €	833 €	2.459 €	3.778 €	2.645 €
CR1815201	4	1800	1500	2010	700	1845	866 €	870 €	2.612 €	4.016 €	2.811 €
CR1818201	5	1800	1800	2010	700	1845	1.289 €	1.273 €	2.922 €	4.471 €	3.130 €
CR1821201	5,9	1800	2100	2010	700	1845	1.540 €	1.524 €	3.239 €	4.977 €	3.483 €
CR1824201	6,7	1800	2400	2010	700	1845	1.543 €	1.528 €	3.510 €	5.393 €	3.774 €
CR1827201	7,7	1800	2700	2010	700	1845	2.072 €	2.045 €	3.868 €	5.943 €	4.160 €
CR1830201	8,5	1800	3000	2010	700	1845	2.230 €	2.242 €	4.449 €	3.504 €	4.784 €
CR1812220	3,5	1800	1200	2200	700	1845	833 €	833 €	2.459 €	4.039 €	2.645 €
CR1815220	4,5	1800	1500	2200	700	1845	866 €	870 €	2.929 €	4.832 €	3.150 €
CR1818220	5,5	1800	1800	2200	700	1845	1.289 €	1.273 €	3.090 €	5.082 €	3.322 €
CR1821220	6,5	1800	2100	2200	700	1845	1.540 €	1.524 €	3.571 €	5.795 €	3.841 €
CR1824220	7,5	1800	2400	2200	700	1845	1.543 €	1.528 €	3.806 €	6.192 €	4.093 €
CR1827220	8,5	1800	2700	2200	700	1845	2.072 €	2.045 €	4.257 €	6.982 €	4.578 €
CR1830220	9,5	1800	3000	2200	700	1845	2.230 €	2.242 €	4.467 €	7.314 €	4.805 €
CR1812240	3,8	1800	1200	2400	700	1845	833 €	833 €	2.759 €	4.739 €	2.971 €
CR1815240	4,9	1800	1500	2400	700	1845	866 €	870 €	3.283 €	5.239 €	3.529 €
CR1818240	6,0	1800	1800	2400	700	1845	1.289 €	1.273 €	3.510 €	5.697 €	3.774 €
CR1821240	7,1	1800	2100	2400	700	1845	1.540 €	1.524 €	3.960 €	6.418 €	4.259 €
CR1824240	8,2	1800	2400	2400	700	1845	1.543 €	1.528 €	4.226 €	6.810 €	4.545 €
CR1827240	9,3	1800	2700	2400	700	1845	2.072 €	2.045 €	4.708 €	7.734 €	5.064 €
CR1830240	10,4	1800	3000	2400	700	1845	2.230 €	2.242 €	4.874 €	8.005 €	5.242 €

Model	Hacim Volume	Dış Ölçüler External Dimensions			Net Kapı Ölçüsü Net Door Dimensions		360 mm Raflar 360 mm Shelves	460 mm Raflar 460 mm Shelves	Tabansız Oda Fiyatı Price Without Floor	İç 430, Dış 430 Paslanmaz Inside 430, Outside 430 Stainless Steel	Fiyat Price
		W	D	H	W	H					
CR2112201	3,7	2100	1200	2010	700	1845	900 €	883 €	2.725 €	4.187 €	2.930 €
CR2115201	4,8	2100	1500	2010	700	1845	928 €	916 €	2.911 €	4.471 €	3.130 €
CR2118201	5,9	2100	1800	2010	700	1845	1.347 €	1.330 €	3.244 €	4.984 €	3.488 €
CR2121201	6,9	2100	2100	2010	700	1845	1.867 €	1.847 €	3.639 €	5.593 €	3.914 €
CR2124201	8	2100	2400	2010	700	1845	1.883 €	1.879 €	3.955 €	6.496 €	4.253 €
CR2127201	9,1	2100	2700	2010	700	1845	2.057 €	2.045 €	4.234 €	6.955 €	4.553 €
CR2130201	10,1	2100	3000	2010	700	1845	2.064 €	2.064 €	4.616 €	7.557 €	4.964 €
CR2112220	4,1	2100	1200	2200	700	1845	900 €	883 €	2.878 €	4.729 €	3.097 €
CR2115220	5,3	2100	1500	2200	700	1845	928 €	916 €	3.349 €	5.501 €	3.602 €
CR2118220	6,5	2100	1800	2200	700	1845	1.347 €	1.330 €	3.571 €	5.966 €	3.841 €
CR2121220	7,7	2100	2100	2200	700	1845	1.867 €	1.847 €	4.060 €	6.614 €	4.365 €
CR2124220	8,9	2100	2400	2200	700	1845	1.883 €	1.879 €	4.320 €	7.661 €	4.645 €
CR2127220	10,1	2100	2700	2200	700	1845	2.057 €	2.045 €	4.844 €	7.923 €	5.210 €
CR2130220	11,2	2100	3000	2200	700	1845	2.064 €	2.064 €	5.098 €	8.428 €	5.482 €
CR2112240	4,5	2100	1200	2400	700	1845	900 €	883 €	3.090 €	5.227 €	3.422 €
CR2115240	5,8	2100	1500	2400	700	1845	928 €	916 €	3.392 €	5.571 €	3.648 €
CR2118240	7,1	2100	1800	2400	700	1845	1.347 €	1.330 €	3.967 €	6.515 €	4.267 €
CR2121240	8,4	2100	2100	2400	700	1845	1.867 €	1.847 €	4.357 €	7.155 €	4.684 €
CR2124240	9,7	2100	2400	2400	700	1845	1.883 €	1.879 €	4.708 €	7.734 €	5.064 €
CR2127240	11,0	2100	2700	2400	700	1845	2.057 €	2.045 €	5.359 €	8.801 €	5.763 €
CR2130240	12,3	2100	3000	2400	700	1845	2.064 €	2.064 €	5.665 €	9.306 €	6.044 €

Tabansız odalarda yükseklik 80 mm düşecektir.
The height of the products without floor is 80 mm less.

Model	Hacim Volume	Dış Ölçüler External Dimensions			Net Kapı Ölçüsü Net Door Dimensions		360 mm Raflar 360 mm Shelves	460 mm Raflar 460 mm Shelves	Tabansız Oda Fiyatı Price Without Floor	İç 430, Dış 430 Paslanmaz Inside 430, Outside 430 Stainless Steel	Fiyat Price
		W	D	H	W	H					
CR2412201	4,3	2400	1200	2010	700	1845	1.176 €	1.147 €	2.817 €	4.330 €	3.030 €
CR2415201	5,5	2400	1500	2010	700	1845	1.207 €	1.172 €	3.182 €	4.889 €	3.422 €
CR2418201	6,7	2400	1800	2010	700	1845	1.631 €	1.556 €	3.506 €	5.387 €	3.770 €
CR2421201	8	2400	2100	2010	700	1845	2.149 €	2.062 €	3.955 €	6.077 €	4.253 €
CR2424201	9	2400	2400	2010	700	1845	2.153 €	2.060 €	4.263 €	6.551 €	4.586 €
CR2427201	10,5	2400	2700	2010	700	1845	2.230 €	2.143 €	4.653 €	7.137 €	5.003 €
CR2430201	11,6	2400	3000	2010	700	1845	2.334 €	2.240 €	5.005 €	7.691 €	5.383 €
CR2412220	4,8	2400	1200	2200	700	1845	1.176 €	1.147 €	3.077 €	5.053 €	3.310 €
CR2415220	6,1	2400	1500	2200	700	1845	1.207 €	1.172 €	3.571 €	5.866 €	3.841 €
CR2418220	7,5	2400	1800	2200	700	1845	1.631 €	1.556 €	3.800 €	6.242 €	4.087 €
CR2421220	8,9	2400	2100	2200	700	1845	2.149 €	2.062 €	4.321 €	7.095 €	4.646 €
CR2424220	10,2	2400	2400	2200	700	1845	2.153 €	2.060 €	4.548 €	7.471 €	4.891 €
CR2427220	11,6	2400	2700	2200	700	1845	2.230 €	2.143 €	5.101 €	8.374 €	5.482 €
CR2430220	13,0	2400	3000	2200	700	1845	2.334 €	2.240 €	5.432 €	8.922 €	5.842 €
CR2412240	5,2	2400	1200	2400	700	1845	1.176 €	1.147 €	3.410 €	5.603 €	3.668 €
CR2415240	6,7	2400	1500	2400	700	1845	1.207 €	1.172 €	4.060 €	6.667 €	4.365 €
CR2418240	8,2	2400	1800	2400	700	1845	1.631 €	1.556 €	4.220 €	6.932 €	4.539 €
CR2421240	9,7	2400	2100	2400	700	1845	2.149 €	2.062 €	4.708 €	7.734 €	5.064 €
CR2424240	11,2	2400	2400	2400	700	1845	2.153 €	2.060 €	5.035 €	8.272 €	5.416 €
CR2427240	12,7	2400	2700	2400	700	1845	2.230 €	2.143 €	5.666 €	9.307 €	6.093 €
CR2430240	14,2	2400	3000	2400	700	1845	2.334 €	2.240 €	5.945 €	9.763 €	6.393 €

Model	Hacim Volume	Dış Ölçüler External Dimensions			Net Kapı Ölçüsü Net Door Dimensions		360 mm Raflar 360 mm Shelves	460 mm Raflar 460 mm Shelves	Tabansız Oda Fiyatı Price Without Floor	İç 430, Dış 430 Paslanmaz Inside 430, Outside 430 Stainless Steel	Fiyat Price
		W	D	H	W	H					
CR2712201	5,1	2700	1200	2010	700	1845	1.226 €	1.234 €	3.090 €	4.748 €	3.322 €
CR2715201	6,3	2700	1500	2010	700	1845	1.265 €	1.265 €	3.571 €	5.488 €	3.841 €
CR2718201	7,7	2700	1800	2010	700	1845	1.693 €	1.672 €	3.868 €	5.943 €	4.160 €
CR2721201	9,1	2700	2100	2010	700	1845	2.206 €	2.169 €	4.232 €	6.504 €	4.551 €
CR2724201	10,5	2700	2400	2010	700	1845	2.207 €	2.196 €	4.655 €	7.154 €	5.006 €
CR2727201	12	2700	2700	2010	700	1845	2.327 €	2.296 €	5.030 €	7.729 €	5.410 €
CR2730201	13,3	2700	3000	2010	700	1845	2.388 €	2.361 €	5.360 €	8.235 €	5.764 €
CR2712220	5,4	2700	1200	2200	700	1845	1.226 €	1.234 €	3.287 €	5.400 €	3.535 €
CR2715220	6,9	2700	1500	2200	700	1845	1.265 €	1.265 €	3.997 €	6.566 €	4.300 €
CR2718220	8,5	2700	1800	2200	700	1845	1.693 €	1.672 €	4.257 €	6.992 €	4.578 €
CR2721220	10,1	2700	2100	2200	700	1845	2.206 €	2.169 €	4.837 €	7.948 €	5.203 €
CR2724220	11,6	2700	2400	2200	700	1845	2.207 €	2.196 €	5.098 €	8.373 €	5.482 €
CR2727220	13,2	2700	2700	2200	700	1845	2.327 €	2.296 €	5.317 €	8.952 €	5.861 €
CR2730220	14,7	2700	3000	2200	700	1845	2.388 €	2.361 €	5.666 €	9.307 €	6.093 €
CR2712240	5,9	2700	1200	2400	700	1845	1.226 €	1.234 €	3.478 €	5.714 €	3.741 €
CR2715240	7,6	2700	1500	2400	700	1845	1.265 €	1.265 €	4.467 €	7.336 €	4.803 €
CR2718240	9,3	2700	1800	2400	700	1845	1.693 €	1.672 €	4.708 €	7.734 €	5.064 €
CR2721240	11	2700	2100	2400	700	1845	2.206 €	2.169 €	5.356 €	8.797 €	5.760 €
CR2724240	12,7	2700	2400	2400	700	1845	2.207 €	2.196 €	5.666 €	9.307 €	6.093 €
CR2727240	14,5	2700	2700	2400	700	1845	2.327 €	2.296 €	6.010 €	9.871 €	6.463 €
CR2730240	16,2	2700	3000	2400	700	1845	2.388 €	2.361 €	6.417 €	10.541 €	6.902 €

Model	Hacim Volume	Dış Ölçüler External Dimensions			Net Kapı Ölçüsü Net Door Dimensions		360 mm Raflar 360 mm Shelves	460 mm Raflar 460 mm Shelves	Tabansız Oda Fiyatı Price Without Floor	İç 430, Dış 430 Paslanmaz Inside 430, Outside 430 Stainless Steel	Fiyat Price
		W	D	H	W	H					
CR3012201	5,4	3000	1200	2010	700	1845	1.276 €	1.284 €	3.343 €	5.490 €	3.595 €
CR3015201	7	3000	1500	2010	700	1845	1.311 €	1.315 €	3.738 €	5.743 €	4.019 €
CR3018201	8,5	3000	1800	2010	700	1845	1.746 €	1.730 €	4.134 €	6.352 €	4.445 €
CR3021201	10,1	3000	2100	2010	700	1845	2.262 €	2.238 €	4.616 €	7.099 €	4.964 €
CR3024201	11,6	3000	2400	2010	700	1845	2.257 €	2.230 €	5.005 €	7.691 €	5.383 €
CR3027201	13,3	3000	2700	2010	700	1845	2.334 €	2.331 €	5.360 €	8.235 €	5.764 €
CR3030201	14,9	3000	3000	2010	700	1845	2.439 €	2.439 €	6.166 €	9.476 €	6.632 €
CR3012220	6,0	3000	1200	2200	700	1845	1.276 €	1.284 €	3.671 €	6.028 €	3.948 €
CR3015220	7,8	3000	1500	2200	700	1845	1.311 €	1.315 €	4.174 €	6.856 €	4.489 €
CR3018220	9,5	3000	1800	2200	700	1845	1.746 €	1.730 €	4.463 €	7.330 €	4.800 €
CR3021220	11,2	3000	2100	2200	700	1845	2.262 €	2.238 €	5.359 €	8.801 €	5.763 €
CR3024220	13,0	3000	2400	2200	700	1845	2.257 €	2.230 €	5.498 €	7.707 €	5.912 €
CR3027220	14,7	3000	2700	2200	700	1845	2.334 €	2.331 €	5.666 €	9.310 €	6.094 €
CR3030220	16,5	3000	3000	2200	700	1845	2.439 €	2.439 €	6.603 €	10.848 €	7.102 €
CR3012240	6,6	3000	1200	2400	700	1845	1.276 €	1.284 €	4.108 €	6.748 €	4.417 €
CR3015240	8,5	3000	1500	2400	700	1845	1.311 €	1.315 €	4.440 €	7.293 €	4.775 €
CR3018240	10,4	3000	1800	2400	700	1845	1.746 €	1.730 €	4.873 €	8.006 €	5.241 €
CR3021240	12,3	3000	2100	2400	700	1845	2.262 €	2.238 €	5.665 €	9.299 €	6.044 €
CR3024240	14,2	3000	2400	2400	700	1845	2.257 €	2.230 €	5.945 €	9.763 €	6.393 €
CR3027240	16,2	3000	2700	2400	700	1845	2.334 €	2.331 €	6.417 €	10.541 €	6.902 €
CR3030240	18,1	3000	3000	2400	700	1845	2.439 €	2.439 €	6.992 €	11.484 €	7.519 €



Tabansız odalarda yükseklik 80 mm düşecektir.
The height of the products without floor is 80 mm less.

80mm SOĞUK ODA YÜKSEKLİKLER / COLD ROOM HEIGHTS : 2010 - 2200 - 2400 mm

Kapı Ölçüleri
Door Dimension
580x1845

Net Kapı Geçiş Ölçüleri / Net Door Passage Dimensions : 700x1845

	1200	1500	1800	2100	2400	2700	3000
1200							
1500							
1800							
2100							
2400							
2700							
3000							

Raf yerleşimi 360mm genişliğinde. / Shelf placement is made for 360mm.
Raflar 4 katlıdır. / Shelf are 4 storeyed.

İç ölçüleri bulmak için 160mm düşülecek. / In order to obtain inside dimensions
160mm must be subtracted to the above measurements.

80mm SOĞUK ODA YÜKSEKLİKLER / COLD ROOM HEIGHTS : 2010 - 2200 - 2400 mm

Kapı Ölçüleri
Door Dimension
580x1845

Net Kapı Geçiş Ölçüleri / Net Door Passage Dimensions : 700x1845

	1200	1500	1800	2100	2400	2700	3000
1200							
1500							
1800							
2100							
2400							
2700							
3000							

Raf yerleşimi 460mm genişliğinde. / Shelf placement is made for 460mm.
Raflar 4 katlıdır. / Shelf are 4 storeyed.

İç ölçüleri bulmak için 160mm düşülecek. / In order to obtain inside dimensions
160mm must be subtracted to the above measurements.

80 mm Oda Paneli / 80 mm Room Panel

NET KAPI GEÇİŞ ÖLÇÜLERİ NET DOOR PASSAGE DIEMENSIONS 850X1845



Model	Hacim Volume	Dış Ölçüler External Dimensions			Net Kapı Ölçüsü Net Door Dimensions		360 mm Raflar 360 mm Shelves	460 mm Raflar 460 mm Shelves	Tabansız Oda Fiyatı Price Without Floor	İç 430, Dış 430 Paslanmaz Inside 430, Outside 430 Stainless Steel	Fiyat Price
		W	D	H	W	H					
CR1812201-GN	3,1	1800	1200	2010	850	1845	833 €	833 €	3.124 €	4.729 €	3.310 €
CR1815201-GN	4	1800	1500	2010	850	1845	866 €	870 €	3.277 €	4.967 €	3.476 €
CR1818201-GN	5	1800	1800	2010	850	1845	1.289 €	1.273 €	3.587 €	5.423 €	3.795 €
CR1821201-GN	5,9	1800	2100	2010	850	1845	1.540 €	1.525 €	3.903 €	5.926 €	4.148 €
CR1824201-GN	6,7	1800	2400	2010	850	1845	1.544 €	1.528 €	4.174 €	6.343 €	4.439 €
CR1827201-GN	7,7	1800	2700	2010	850	1845	2.072 €	2.045 €	4.532 €	6.895 €	4.825 €
CR1830201-GN	8,5	1800	3000	2010	850	1845	2.230 €	2.242 €	5.113 €	7.787 €	5.449 €
CR1812220-GN	3,5	1800	1200	2200	850	1845	833 €	833 €	3.124 €	5.218 €	3.310 €
CR1815220-GN	4,5	1800	1500	2200	850	1845	866 €	870 €	3.593 €	6.014 €	3.815 €
CR1818220-GN	5,5	1800	1800	2200	850	1845	1.289 €	1.273 €	3.754 €	6.287 €	3.987 €
CR1821220-GN	6,5	1800	2100	2200	850	1845	1.540 €	1.525 €	4.235 €	7.104 €	4.506 €
CR1824220-GN	7,5	1800	2400	2200	850	1845	1.544 €	1.528 €	4.470 €	7.502 €	4.758 €
CR1827220-GN	8,5	1800	2700	2200	850	1845	2.072 €	2.045 €	4.921 €	8.267 €	5.242 €
CR1830220-GN	9,5	1800	3000	2200	850	1845	2.230 €	2.242 €	5.131 €	8.624 €	5.469 €
CR1812240-GN	3,8	1800	1200	2400	850	1845	833 €	833 €	3.424 €	5.731 €	3.635 €
CR1815240-GN	4,9	1800	1500	2400	850	1845	866 €	870 €	3.948 €	6.611 €	4.193 €
CR1818240-GN	6,0	1800	1800	2400	850	1845	1.289 €	1.273 €	4.174 €	6.999 €	4.439 €
CR1821240-GN	7,1	1800	2100	2400	850	1845	1.540 €	1.525 €	4.625 €	7.764 €	4.924 €
CR1824240-GN	8,2	1800	2400	2400	850	1845	1.544 €	1.528 €	4.891 €	8.215 €	5.210 €
CR1827240-GN	9,3	1800	2700	2400	850	1845	2.072 €	2.045 €	5.373 €	9.031 €	5.729 €
CR1830240-GN	10,4	1800	3000	2400	850	1845	2.230 €	2.242 €	5.539 €	9.315 €	5.907 €
CR2112201-GN	3,7	2100	1200	2010	850	1845	900 €	883 €	3.390 €	5.137 €	3.595 €
CR2115201-GN	4,8	2100	1500	2010	850	1845	928 €	916 €	3.576 €	5.423 €	3.795 €
CR2118201-GN	5,9	2100	1800	2010	850	1845	1.347 €	1.330 €	3.908 €	5.934 €	4.153 €
CR2121201-GN	6,9	2100	2100	2010	850	1845	1.867 €	1.847 €	4.303 €	6.542 €	4.578 €
CR2124201-GN	8	2100	2400	2010	850	1845	1.883 €	1.879 €	4.620 €	7.026 €	4.917 €
CR2127201-GN	9,1	2100	2700	2010	850	1845	2.057 €	2.045 €	4.898 €	7.456 €	5.217 €
CR2130201-GN	10,1	2100	3000	2010	850	1845	2.064 €	2.064 €	5.280 €	8.043 €	5.629 €
CR2112220-GN	4,1	2100	1200	2200	850	1845	900 €	883 €	3.543 €	5.930 €	3.762 €
CR2115220-GN	5,3	2100	1500	2200	850	1845	928 €	916 €	4.014 €	6.726 €	4.267 €
CR2118220-GN	6,5	2100	1800	2200	850	1845	1.347 €	1.330 €	4.235 €	7.104 €	4.506 €
CR2121220-GN	7,7	2100	2100	2200	850	1845	1.867 €	1.847 €	4.725 €	7.931 €	5.030 €
CR2124220-GN	8,9	2100	2400	2200	850	1845	1.883 €	1.879 €	4.984 €	8.372 €	5.310 €
CR2127220-GN	10,1	2100	2700	2200	850	1845	2.057 €	2.045 €	5.508 €	9.262 €	5.874 €
CR2130220-GN	11,2	2100	3000	2200	850	1845	2.064 €	2.064 €	5.763 €	9.692 €	6.146 €
CR2112240-GN	4,5	2100	1200	2400	850	1845	900 €	883 €	3.754 €	6.444 €	4.087 €
CR2115240-GN	5,8	2100	1500	2400	850	1845	928 €	916 €	4.057 €	6.800 €	4.312 €
CR2118240-GN	7,1	2100	1800	2400	850	1845	1.347 €	1.330 €	4.631 €	7.774 €	4.931 €
CR2121240-GN	8,4	2100	2100	2400	850	1845	1.867 €	1.847 €	5.021 €	8.434 €	5.349 €
CR2124240-GN	9,7	2100	2400	2400	850	1845	1.883 €	1.879 €	5.373 €	9.031 €	5.729 €
CR2127240-GN	11,0	2100	2700	2400	850	1845	2.057 €	2.045 €	6.023 €	10.156 €	6.440 €
CR2130240-GN	12,3	2100	3000	2400	850	1845	2.064 €	2.064 €	6.330 €	10.578 €	6.708 €

Model	Hacim Volume m ³	Dış Ölçüler External Dimensions			Net Kapı Ölçüsü Net Door Dimensions		360 mm Rafklar 360 mm Shelves	460 mm Rafklar 460 mm Shelves	Tabansız Oda Fiyatı Price Without Floor	İç 430, Dış 430 Paslanmaz Inside 430, Outside 430 Stainless Steel	Fiyat Price
		W	D	H	W	H					
CR2412201-GN	4,3	2400	1200	2010	850	1845	1.147 €	1.147 €	3.482 €	5.280 €	3.695 €
CR2415201-GN	5,5	2400	1500	2010	850	1845	1.172 €	1.172 €	3.846 €	5.839 €	4.087 €
CR2418201-GN	6,7	2400	1800	2010	850	1845	1.584 €	1.556 €	4.170 €	6.338 €	4.435 €
CR2421201-GN	8	2400	2100	2010	850	1845	2.086 €	2.062 €	4.620 €	7.026 €	4.917 €
CR2424201-GN	9	2400	2400	2010	850	1845	2.090 €	2.060 €	4.927 €	7.502 €	5.250 €
CR2427201-GN	10,5	2400	2700	2010	850	1845	2.165 €	2.143 €	5.317 €	8.100 €	5.668 €
CR2430201-GN	11,6	2400	3000	2010	850	1845	2.266 €	2.240 €	5.669 €	8.641 €	6.047 €
CR2412220-GN	4,8	2400	1200	2200	850	1845	1.147 €	1.147 €	3.741 €	6.266 €	3.974 €
CR2415220-GN	6,1	2400	1500	2200	850	1845	1.172 €	1.172 €	4.235 €	7.104 €	4.506 €
CR2418220-GN	7,5	2400	1800	2200	850	1845	1.584 €	1.556 €	4.464 €	7.491 €	4.751 €
CR2421220-GN	8,9	2400	2100	2200	850	1845	2.086 €	2.062 €	4.986 €	8.374 €	5.311 €
CR2424220-GN	10,2	2400	2400	2200	850	1845	2.090 €	2.060 €	5.212 €	8.759 €	5.555 €
CR2427220-GN	11,6	2400	2700	2200	850	1845	2.165 €	2.143 €	5.765 €	9.692 €	6.146 €
CR2430220-GN	13,0	2400	3000	2200	850	1845	2.266 €	2.240 €	6.097 €	10.260 €	6.507 €
CR2412240-GN	5,2	2400	1200	2400	850	1845	1.147 €	1.147 €	4.074 €	6.831 €	4.332 €
CR2415240-GN	6,7	2400	1500	2400	850	1845	1.172 €	1.172 €	4.725 €	7.931 €	5.030 €
CR2418240-GN	8,2	2400	1800	2400	850	1845	1.584 €	1.556 €	4.884 €	8.204 €	5.203 €
CR2421240-GN	9,7	2400	2100	2400	850	1845	2.086 €	2.062 €	5.373 €	9.031 €	5.729 €
CR2424240-GN	11,2	2400	2400	2400	850	1845	2.090 €	2.060 €	5.699 €	9.587 €	6.080 €
CR2427240-GN	12,7	2400	2700	2400	850	1845	2.165 €	2.143 €	6.331 €	10.655 €	6.758 €
CR2430240-GN	14,2	2400	3000	2400	850	1845	2.266 €	2.240 €	6.609 €	11.127 €	7.057 €

Model	Hacim Volume m ³	Dış Ölçüler External Dimensions			Net Kapı Ölçüsü Net Door Dimensions		360 mm Rafklar 360 mm Shelves	460 mm Rafklar 460 mm Shelves	Tabansız Oda Fiyatı Price Without Floor	İç 430, Dış 430 Paslanmaz Inside 430, Outside 430 Stainless Steel	Fiyat Price
		W	D	H	W	H					
CR3012201-GN	5,4	3000	1200	2010	850	1845	1.276 €	1.284 €	4.007 €	6.086 €	4.259 €
CR3015201-GN	7	3000	1500	2010	850	1845	1.311 €	1.315 €	4.402 €	6.693 €	4.683 €
CR3018201-GN	8,5	3000	1800	2010	850	1845	1.746 €	1.730 €	4.798 €	7.301 €	5.110 €
CR3021201-GN	10,1	3000	2100	2010	850	1845	2.262 €	2.238 €	5.280 €	8.043 €	5.629 €
CR3024201-GN	11,6	3000	2400	2010	850	1845	2.257 €	2.230 €	5.669 €	8.641 €	6.047 €
CR3027201-GN	13,3	3000	2700	2010	850	1845	2.334 €	2.331 €	6.025 €	9.186 €	6.428 €
CR3030201-GN	14,9	3000	3000	2010	850	1845	2.439 €	2.439 €	6.831 €	10.426 €	7.297 €
CR3012220-GN	6,0	3000	1200	2200	850	1845	1.276 €	1.284 €	4.335 €	7.272 €	4.612 €
CR3015220-GN	7,8	3000	1500	2200	850	1845	1.311 €	1.315 €	4.839 €	8.126 €	5.154 €
CR3018220-GN	9,5	3000	1800	2200	850	1845	1.746 €	1.730 €	5.127 €	8.615 €	5.464 €
CR3021220-GN	11,2	3000	2100	2200	850	1845	2.262 €	2.238 €	6.023 €	10.134 €	6.427 €
CR3024220-GN	13,0	3000	2400	2200	850	1845	2.257 €	2.230 €	6.047 €	10.370 €	6.577 €
CR3027220-GN	14,7	3000	2700	2200	850	1845	2.334 €	2.331 €	6.331 €	10.658 €	6.759 €
CR3030220-GN	16,5	3000	3000	2200	850	1845	2.439 €	2.439 €	7.268 €	12.246 €	7.766 €
CR3012240-GN	6,6	3000	1200	2400	850	1845	1.276 €	1.284 €	4.773 €	8.013 €	5.082 €
CR3015240-GN	8,5	3000	1500	2400	850	1845	1.311 €	1.315 €	5.105 €	8.578 €	5.440 €
CR3018240-GN	10,4	3000	1800	2400	850	1845	1.746 €	1.730 €	5.537 €	9.312 €	5.906 €
CR3021240-GN	12,3	3000	2100	2400	850	1845	2.262 €	2.238 €	6.284 €	10.578 €	6.708 €
CR3024240-GN	14,2	3000	2400	2400	850	1845	2.257 €	2.230 €	6.609 €	11.127 €	7.057 €
CR3027240-GN	16,2	3000	2700	2400	850	1845	2.334 €	2.331 €	7.166 €	11.930 €	7.566 €
CR3030240-GN	18,1	3000	3000	2400	850	1845	2.439 €	2.439 €	7.656 €	12.904 €	8.184 €

Model	Hacim Volume m ³	Dış Ölçüler External Dimensions			Net Kapı Ölçüsü Net Door Dimensions		360 mm Rafklar 360 mm Shelves	460 mm Rafklar 460 mm Shelves	Tabansız Oda Fiyatı Price Without Floor	İç 430, Dış 430 Paslanmaz Inside 430, Outside 430 Stainless Steel	Fiyat Price
		W	D	H	W	H					
CR2712201-GN	5,1	2700	1200	2010	850	1845	1.225 €	1.234 €	3.754 €	5.697 €	3.987 €
CR2715201-GN	6,3	2700	1500	2010	850	1845	1.266 €	1.265 €	4.235 €	6.439 €	4.506 €
CR2718201-GN	7,7	2700	1800	2010	850	1845	1.693 €	1.672 €	4.532 €	6.895 €	4.825 €
CR2721201-GN	9,1	2700	2100	2010	850	1845	2.206 €	2.169 €	4.897 €	7.453 €	5.216 €
CR2724201-GN	10,5	2700	2400	2010	850	1845	2.207 €	2.196 €	5.320 €	8.103 €	5.670 €
CR2727201-GN	12	2700	2700	2010	850	1845	2.327 €	2.296 €	5.694 €	8.680 €	6.074 €
CR2730201-GN	13,3	2700	3000	2010	850	1845	2.388 €	2.361 €	6.025 €	9.186 €	6.428 €
CR2712220-GN	5,4	2700	1200	2200	850	1845	1.225 €	1.234 €	3.951 €	6.621 €	4.200 €
CR2715220-GN	6,9	2700	1500	2200	850	1845	1.266 €	1.265 €	4.662 €	7.826 €	4.964 €
CR2718220-GN	8,5	2700	1800	2200	850	1845	1.693 €	1.672 €	4.921 €	8.267 €	5.242 €
CR2721220-GN	10,1	2700	2100	2200	850	1845	2.206 €	2.169 €	5.502 €	9.252 €	5.868 €
CR2724220-GN	11,6	2700	2400	2200	850	1845	2.207 €	2.196 €	5.763 €	9.692 €	6.146 €
CR2727220-GN	13,2	2700	2700	2200	850	1845	2.327 €	2.296 €	5.982 €	10.288 €	6.526 €
CR2730220-GN	14,7	2700	3000	2200	850	1845	2.388 €	2.361 €	6.331 €	10.655 €	6.758 €
CR2712240-GN	5,9	2700	1200	2400	850	1845	1.225 €	1.234 €	4.143 €	6.947 €	4.406 €
CR2715240-GN	7,6	2700	1500	2400	850	1845	1.266 €	1.265 €	5.131 €	8.621 €	5.468 €
CR2718240-GN	9,3	2700	1800	2400	850	1845	1.693 €	1.672 €	5.373 €	9.031 €	5.729 €
CR2721240-GN	11	2700	2100	2400	850	1845	2.206 €	2.169 €	6.021 €	10.129 €	6.425 €
CR2724240-GN	12,7	2700	2400	2400	850	1845	2.207 €	2.196 €	6.328 €	10.655 €	6.758 €
CR2727240-GN	14,5	2700	2700	2400	850	1845	2.327 €	2.296 €	6.674 €	11.239 €	7.127 €
CR2730240-GN	16,2	2700	3000	2400	850	1845	2.388 €	2.361 €	7.082 €	11.930 €	7.566 €



Tabansız odalarda yükseklik 80 mm düşecektir.
The height of the products without floor is 80 mm less.

80mm SOĞUK ODA YÜKSEKLİKLER / COLD ROOM HEIGHTS : 2010 - 2200 - 2400 mm

Net Kapı Geçiş Ölçüleri / Net Door Passage Dimensions : 850x1845

	1800	2100	2400	2700	3000
1200					
1500					
1800					
2100					
2400					
2700					
3000					

Raf yerleşimi 360mm genişliğinde. / Shelf placement is made for 360mm.
Raflar 4 katlıdır. / Shelf are 4 storeyed.

İç ölçüleri bulmak için 160mm düşülecek. / In order to obtain inside dimensions
160mm must be subtracted to the above measurements.

80mm SOĞUK ODA YÜKSEKLİKLER / COLD ROOM HEIGHTS : 2010 - 2200 - 2400 mm

Net Kapı Geçiş Ölçüleri / Net Door Passage Dimensions : 850x1845

	1800	2100	2400	2700	3000
1200					
1500					
1800					
2100					
2400					
2700					
3000					

Raf yerleşimi 460mm genişliğinde. / Shelf placement is made for 460mm.
Raflar 4 katlıdır. / Shelf are 4 storeyed.

İç ölçüleri bulmak için 160mm düşülecek. / In order to obtain inside dimensions
160mm must be subtracted to the above measurements.

80 mm Camlı Panel ve Kapı 80 mm Glass Panel and Glass Door

Her Cam
Panelde Işık
Mevcuttur.
Glass Panels
Have Light
Included



60'lık Panel, Oda Yüksekliği: 201cm
60 cm Panel, Room Height: 201 cm

Ölçüler: 600x1880 mm
Dimensions: 600x1880 mm

Fiyat

Price

Model	PA600-G-MM	1.145 €
Model	PA600-G-MF	1.145 €
Model	PA600-G-FM	1.145 €

90'lık Panel, Oda Yüksekliği: 201cm
90 cm Panel, Room Height: 201 cm

Ölçüler: 900x1880 mm
Dimensions: 900x1880 mm

Fiyat

Price

Model	PA900-G-MM	1.551 €
Model	PA900-G-MF	1.551 €
Model	PA900-G-FM	1.551 €

220 ve 240 cm yüksekliğindeki paneller için fiyat alınır / Ask price for panels with 220 & 240 Cm height.

FRENOX
PROFESSIONAL REFRIGERATION



Cam Kapı, Oda Yüksekliği: 201cm
Glass Door, Room Height: 201 cm

Net Kapı Ölçüleri:
Net Door Passage Dimensions:
700x1845 mm

Ölçüler: 900x1880 mm
Dimensions: 900x1880 mm

Fiyat

Price

Model	KA20190-G	4.425 €
--------------	-----------	---------



120 mm Oda Paneli / 120 mm Room Panel

Model	Hacim Volume m ³	Dış Ölçüler External Dimensions			Net Kapı Ölçüsü Net Door Dimensions		360 mm Raflar 360 mm Shelves	460 mm Raflar 460 mm Shelves	Tabansız Oda Fiyatı Price Without Floor	İç 430, Dış 430 Paslanmaz Inside 430, Outside 430 Stainless Steel	Fiyat Price
		W	D	H	W	H					
CL1212201	1,6	1200	1200	2010	580	1765	364 €	373 €	2.335 €	3.589 €	2.512 €
CL1215201	2,2	1200	1500	2010	580	1765	364 €	373 €	2.638 €	4.033 €	2.822 €
CL1218201	2,7	1200	1800	2010	580	1765	720 €	711 €	2.840 €	4.344 €	3.040 €
CL1221201	3,2	1200	2100	2010	580	1765	767 €	763 €	3.148 €	4.813 €	3.369 €
CL1224201	3,7	1200	2400	2010	580	1765	863 €	863 €	3.254 €	4.976 €	3.482 €
CL1227201	4,1	1200	2700	2010	580	1765	1.049 €	1.045 €	3.569 €	5.457 €	3.820 €
CL1230201	4,7	1200	3000	2010	580	1765	1.097 €	1.088 €	3.863 €	5.906 €	4.134 €
CL1212220	1,8	1200	1200	2200	580	1765	364 €	373 €	2.609 €	4.263 €	2.791 €
CL1215220	2,4	1200	1500	2200	580	1765	364 €	373 €	2.786 €	4.574 €	2.996 €
CL1218220	2,9	1200	1800	2200	580	1765	720 €	711 €	3.024 €	4.967 €	3.252 €
CL1221220	3,5	1200	2100	2200	580	1765	767 €	763 €	3.312 €	5.441 €	3.562 €
CL1224220	4,1	1200	2400	2200	580	1765	863 €	863 €	3.535 €	5.811 €	3.805 €
CL1227220	4,6	1200	2700	2200	580	1765	1.049 €	1.045 €	3.959 €	6.504 €	4.258 €
CL1230220	5,2	1200	3000	2200	580	1765	1.097 €	1.088 €	4.220 €	6.941 €	4.538 €
CL1212240	2,0	1200	1200	2400	580	1765	364 €	373 €	2.763 €	4.564 €	2.972 €
CL1215240	2,6	1200	1500	2400	580	1765	364 €	373 €	3.068 €	4.935 €	3.233 €
CL1218240	3,2	1200	1800	2400	580	1765	720 €	711 €	3.177 €	5.213 €	3.416 €
CL1221240	3,9	1200	2100	2400	580	1765	767 €	763 €	3.662 €	6.014 €	3.938 €
CL1224240	4,5	1200	2400	2400	580	1765	863 €	863 €	3.922 €	6.442 €	4.219 €
CL1227240	5,1	1200	2700	2400	580	1765	1.049 €	1.045 €	4.467 €	7.336 €	4.803 €
CL1230240	5,7	1200	3000	2400	580	1765	1.097 €	1.088 €	4.708 €	7.739 €	5.064 €

Model	Hacim Volume m ³	Dış Ölçüler External Dimensions			Net Kapı Ölçüsü Net Door Dimensions		360 mm Raflar 360 mm Shelves	460 mm Raflar 460 mm Shelves	Tabansız Oda Fiyatı Price Without Floor	İç 430, Dış 430 Paslanmaz Inside 430, Outside 430 Stainless Steel	Fiyat Price
		W	D	H	W	H					
CL1512201	2,2	1500	1200	2010	700	1765	421 €	429 €	2.625 €	4.033 €	2.822 €
CL1515201	2,8	1500	1500	2010	700	1765	421 €	429 €	2.728 €	4.191 €	2.933 €
CL1518201	3,5	1500	1800	2010	700	1765	776 €	772 €	3.007 €	4.610 €	3.235 €
CL1521201	4,2	1500	2100	2010	700	1765	819 €	811 €	3.344 €	5.138 €	3.596 €
CL1524201	4,9	1500	2400	2010	700	1765	828 €	824 €	3.665 €	5.668 €	3.931 €
CL1527201	5,5	1500	2700	2010	700	1765	1.110 €	1.101 €	3.989 €	6.315 €	4.419 €
CL1530201	6,2	1500	3000	2010	700	1765	1.249 €	1.240 €	4.293 €	6.597 €	4.617 €
CL1512220	2,4	1500	1200	2200	700	1765	421 €	429 €	2.767 €	4.748 €	2.976 €
CL1515220	3,1	1500	1500	2200	700	1765	421 €	429 €	3.119 €	5.124 €	3.354 €
CL1518220	3,9	1500	1800	2200	700	1765	776 €	772 €	3.360 €	5.521 €	3.615 €
CL1521220	4,6	1500	2100	2200	700	1765	819 €	811 €	3.848 €	6.320 €	4.138 €
CL1524220	5,3	1500	2400	2200	700	1765	828 €	824 €	4.111 €	6.752 €	4.420 €
CL1527220	6,1	1500	2700	2200	700	1765	1.110 €	1.101 €	4.594 €	7.546 €	4.941 €
CL1530220	6,8	1500	3000	2200	700	1765	1.249 €	1.240 €	4.801 €	7.885 €	5.161 €
CL1512240	2,6	1500	1200	2400	700	1765	421 €	429 €	3.005 €	4.936 €	3.233 €
CL1515240	3,5	1500	1500	2400	700	1765	421 €	429 €	3.510 €	5.765 €	3.774 €
CL1518240	4,3	1500	1800	2400	700	1765	776 €	772 €	3.773 €	6.197 €	4.058 €
CL1521240	5,1	1500	2100	2400	700	1765	819 €	811 €	4.294 €	7.054 €	4.619 €
CL1524240	5,9	1500	2400	2400	700	1765	828 €	824 €	4.669 €	7.682 €	5.021 €
CL1527240	6,7	1500	2700	2400	700	1765	1.110 €	1.101 €	5.056 €	8.436 €	5.523 €
CL1530240	7,5	1500	3000	2400	700	1765	1.249 €	1.240 €	5.201 €	8.323 €	5.449 €

Model	Hacim Volume m ³	Dış Ölçüler External Dimensions			Net Kapı Ölçüsü Net Door Dimensions		360 mm Raflar 360 mm Shelves	460 mm Raflar 460 mm Shelves	Tabansız Oda Fiyatı Price Without Floor	İç 430, Dış 430 Paslanmaz Inside 430, Outside 430 Stainless Steel	Fiyat Price
		W	D	H	W	H					
CL1812201	2,7	1800	1200	2010	700	1765	791 €	778 €	2.822 €	4.337 €	3.035 €
CL1815201	3,5	1800	1500	2010	700	1765	841 €	832 €	3.007 €	4.622 €	3.235 €
CL1818201	4,3	1800	1800	2010	700	1765	1.466 €	1.437 €	3.344 €	5.241 €	3.596 €
CL1821201	5,2	1800	2100	2010	700	1765	1.492 €	1.508 €	3.727 €	5.729 €	4.010 €
CL1824201	6	1800	2400	2010	700	1765	1.536 €	1.551 €	4.031 €	6.182 €	4.335 €
CL1827201	6,8	1800	2700	2010	700	1765	2.176 €	2.149 €	4.448 €	6.833 €	4.783 €
CL1830201	7,7	1800	3000	2010	700	1765	2.261 €	2.238 €	4.751 €	7.301 €	5.110 €
CL1812220	3,0	1800	1200	2200	700	1765	791 €	778 €	3.025 €	4.967 €	3.252 €
CL1815220	3,9	1800	1500	2200	700	1765	841 €	832 €	3.363 €	5.522 €	3.616 €
CL1818220	4,8	1800	1800	2200	700	1765	1.466 €	1.437 €	3.552 €	5.833 €	3.820 €
CL1821220	5,7	1800	2100	2200	700	1765	1.492 €	1.508 €	4.110 €	6.749 €	4.419 €
CL1824220	6,6	1800	2400	2200	700	1765	1.536 €	1.551 €	4.369 €	7.177 €	4.700 €
CL1827220	7,5	1800	2700	2200	700	1765	2.176 €	2.149 €	4.891 €	8.033 €	5.260 €
CL1830220	8,4	1800	3000	2200	700	1765	2.261 €	2.238 €	5.135 €	8.434 €	5.522 €
CL1812240	3,2	1800	1200	2400	700	1765	791 €	778 €	3.174 €	5.214 €	3.414 €
CL1815240	4,2	1800	1500	2400	700	1765	841 €	832 €	3.772 €	6.195 €	4.057 €
CL1818240	5,3	1800	1800	2400	700	1765	1.466 €	1.437 €	4.032 €	6.623 €	4.336 €
CL1821240	6,3	1800	2100	2400	700	1765	1.492 €	1.508 €	4.554 €	7.480 €	4.899 €
CL1824240	7,3	1800	2400	2400	700	1765	1.536 €	1.551 €	4.855 €	7.974 €	5.221 €
CL1827240	8,3	1800	2700	2400	700	1765	2.176 €	2.149 €	5.413 €	8.892 €	5.821 €
CL1830240	9,3	1800	3000	2400	700	1765	2.261 €	2.238 €	5.602 €	9.202 €	6.025 €

Model	Hacim Volume m ³	Dış Ölçüler External Dimensions			Net Kapı Ölçüsü Net Door Dimensions		360 mm Raflar 360 mm Shelves	460 mm Raflar 460 mm Shelves	Tabansız Oda Fiyatı Price Without Floor	İç 430, Dış 430 Paslanmaz Inside 430, Outside 430 Stainless Steel	Fiyat Price
		W	D	H	W	H					
CL2112201	3,2	2100	1200	2010	700	1765	833 €	841 €	3.133 €	4.813 €	3.369 €
CL2115201	4,2	2100	1500	2010	700	1765	882 €	895 €	3.344 €	5.138 €	3.596 €
CL2118201	5,1	2100	1800	2010	700	1765	1.545 €	1.590 €	3.727 €	5.694 €	4.010 €
CL2121201	6,1	2100	2100	2010	700	1765	1.585 €	1.568 €	4.183 €	6.428 €	4.498 €
CL2124201	7,1	2100	2400	2010	700	1765	1.833 €	1.821 €	4.545 €	6.982 €	4.887 €
CL2127201	8,1	2100	2700	2010	700	1765	1.925 €	1.910 €	4.869 €	7.520 €	5.236 €
CL2130201	9,1	2100	3000	2010	700	1765	2.030 €	2.022 €	5.397 €	8.293 €	5.803 €
CL2112220	3,5	2100	1200	2200	700	1765	833 €	841 €	3.312 €	5.441 €	3.562 €
CL2115220	4,6	2100	1500	2200	700	1765	882 €	895 €	3.844 €	6.317 €	4.136 €
CL2118220	5,7	2100	1800	2200	700	1765	1.545 €	1.590 €	4.110 €	6.749 €	4.419 €
CL2121220	6,8	2100	2100	2200	700	1765	1.585 €	1.568 €	4.669 €	7.668 €	5.021 €
CL2124220	7,9	2100	2400	2200	700	1765	1.833 €	1.821 €	4.967 €	8.158 €	5.341 €
CL2127220	9,0	2100	2700	2200	700	1765	1.925 €	1.910 €	5.564 €	9.140 €	5.984 €
CL2130220	10,1	2100	3000	2200	700	1765	2.030 €	2.022 €	5.861 €	9.628 €	6.303 €
CL2112240	3,9	2100	1200	2400	700	1765	833 €	841 €	3.662 €	6.014 €	3.938 €
CL2115240	5,1	2100	1500	2400	700	1765	882 €	895 €	4.296 €	7.056 €	4.620 €
CL2118240	6,3	2100	1800	2400	700	1765	1.545 €	1.590 €	4.555 €	7.480 €	4.899 €
CL2121240	7,5	2100	2100	2400	700	1765	1.585 €	1.568 €	5.227 €	8.586 €	5.622 €
CL2124240	8,7	2100	2400	2400	700	1765	1.833 €	1.821 €	5.460 €	8.970 €	5.873 €
CL2127240	9,9	2100	2700	2400	700	1765	1.925 €	1.910 €	6.161 €	10.111 €	6.625 €
CL2130240	11,1	2100	3000	2400	700	1765	2.030 €	2.022 €	6.460 €	10.610 €	6.946 €

Tabansız odalarda yükseklik 120 mm düşecektir.
The height of the products without floor is 120 mm less.

Model	Hacim Volume m³	Dış Ölçüler External Dimensions			Net Kapı Ölçüsü Net Door Dimensions		360 mm Raflar 360 mm Shelves	460 mm Raflar 460 mm Shelves	Tabansız Oda Fiyatı Price Without Floor	İç 430, Dış 430 Paslanmaz Inside 430, Outside 430 Stainless Steel	Fiyat Price
		W	D	H	W	H					
CL2412201	3,7	2400	1200	2010	700	1765	1.130 €	1.130 €	3.239 €	4.977 €	3.483 €
CL2415201	4,9	2400	1500	2010	700	1765	1.182 €	1.178 €	3.655 €	5.617 €	3.931 €
CL2418201	6	2400	1800	2010	700	1765	1.804 €	1.750 €	4.031 €	6.182 €	4.335 €
CL2421201	7,1	2400	2100	2010	700	1765	1.645 €	1.625 €	4.544 €	6.982 €	4.887 €
CL2424201	8,3	2400	2400	2010	700	1765	1.891 €	1.868 €	4.901 €	7.527 €	5.268 €
CL2427201	9,4	2400	2700	2010	700	1765	1.983 €	1.964 €	5.348 €	8.217 €	5.750 €
CL2430201	10,6	2400	3000	2010	700	1765	2.084 €	2.076 €	5.756 €	8.807 €	6.189 €
CL2412220	4,1	2400	1200	2200	700	1765	1.130 €	1.130 €	3.621 €	5.904 €	3.865 €
CL2415220	5,3	2400	1500	2200	700	1765	1.182 €	1.178 €	4.110 €	6.749 €	4.419 €
CL2418220	6,6	2400	1800	2200	700	1765	1.804 €	1.750 €	4.369 €	7.177 €	4.705 €
CL2421220	7,9	2400	2100	2200	700	1765	1.645 €	1.625 €	5.015 €	8.149 €	5.341 €
CL2424220	9,1	2400	2400	2200	700	1765	1.891 €	1.868 €	5.227 €	8.586 €	5.622 €
CL2427220	10,4	2400	2700	2200	700	1765	1.983 €	1.964 €	5.861 €	9.628 €	6.303 €
CL2430220	11,7	2400	3000	2200	700	1765	2.084 €	2.076 €	6.160 €	10.117 €	6.623 €
CL2412240	4,5	2400	1200	2400	700	1765	1.130 €	1.130 €	3.662 €	6.538 €	3.938 €
CL2415240	5,9	2400	1500	2400	700	1765	1.182 €	1.178 €	4.669 €	7.668 €	5.021 €
CL2418240	7,3	2400	1800	2400	700	1765	1.804 €	1.750 €	4.855 €	7.974 €	5.221 €
CL2421240	8,7	2400	2100	2400	700	1765	1.645 €	1.625 €	5.460 €	8.970 €	5.873 €
CL2424240	10,1	2400	2400	2400	700	1765	1.891 €	1.868 €	5.788 €	9.871 €	6.223 €
CL2427240	11,5	2400	2700	2400	700	1765	1.983 €	1.964 €	6.515 €	10.701 €	7.007 €
CL2430240	12,9	2400	3000	2400	700	1765	2.084 €	2.076 €	6.832 €	11.222 €	7.347 €

Model	Hacim Volume m³	Dış Ölçüler External Dimensions			Net Kapı Ölçüsü Net Door Dimensions		360 mm Raflar 360 mm Shelves	460 mm Raflar 460 mm Shelves	Tabansız Oda Fiyatı Price Without Floor	İç 430, Dış 430 Paslanmaz Inside 430, Outside 430 Stainless Steel	Fiyat Price
		W	D	H	W	H					
CL3012201	4,7	3000	1200	2010	700	1765	1.234 €	1.238 €	3.845 €	5.896 €	4.135 €
CL3015201	6,2	3000	1500	2010	700	1765	1.286 €	1.290 €	4.293 €	6.597 €	4.617 €
CL3018201	7,7	3000	1800	2010	700	1765	1.907 €	1.895 €	4.753 €	7.291 €	5.111 €
CL3021201	9,1	3000	2100	2010	700	1765	1.980 €	1.968 €	5.307 €	8.155 €	5.707 €
CL3024201	10,6	3000	2400	2010	700	1765	2.006 €	1.999 €	5.756 €	8.581 €	6.189 €
CL3027201	12	3000	2700	2010	700	1765	2.439 €	2.427 €	6.161 €	10.184 €	6.625 €
CL3030201	13,5	3000	3000	2010	700	1765	2.539 €	2.535 €	7.087 €	11.527 €	7.621 €
CL3012220	5,2	3000	1200	2200	700	1765	1.234 €	1.238 €	4.220 €	7.154 €	4.538 €
CL3015220	6,8	3000	1500	2200	700	1765	1.286 €	1.290 €	4.801 €	7.859 €	5.161 €
CL3018220	8,4	3000	1800	2200	700	1765	1.907 €	1.895 €	5.601 €	9.168 €	6.023 €
CL3021220	10,1	3000	2100	2200	700	1765	1.980 €	1.968 €	5.850 €	9.666 €	6.303 €
CL3024220	11,7	3000	2400	2200	700	1765	2.006 €	1.999 €	6.630 €	10.177 €	6.625 €
CL3027220	13,3	3000	2700	2200	700	1765	2.439 €	2.427 €	6.517 €	10.872 €	7.009 €
CL3030220	14,9	3000	3000	2200	700	1765	2.539 €	2.535 €	7.593 €	12.512 €	8.165 €
CL3012240	5,7	3000	1200	2400	700	1765	1.234 €	1.238 €	4.720 €	7.752 €	5.075 €
CL3015240	7,5	3000	1500	2400	700	1765	1.286 €	1.290 €	5.069 €	8.327 €	5.451 €
CL3018240	9,3	3000	1800	2400	700	1765	1.907 €	1.895 €	5.601 €	9.200 €	6.023 €
CL3021240	11,1	3000	2100	2400	700	1765	1.980 €	1.968 €	6.460 €	10.610 €	6.946 €
CL3024240	12,9	3000	2400	2400	700	1765	2.006 €	1.999 €	6.832 €	11.222 €	7.347 €
CL3027240	14,7	3000	2700	2400	700	1765	2.439 €	2.427 €	7.161 €	11.764 €	7.702 €
CL3030240	16,5	3000	3000	2400	700	1765	2.539 €	2.535 €	7.975 €	12.039 €	8.576 €

Model	Hacim Volume m³	Dış Ölçüler External Dimensions			Net Kapı Ölçüsü Net Door Dimensions		360 mm Raflar 360 mm Shelves	460 mm Raflar 460 mm Shelves	Tabansız Oda Fiyatı Price Without Floor	İç 430, Dış 430 Paslanmaz Inside 430, Outside 430 Stainless Steel	Fiyat Price
		W	D	H	W	H					
CL2712201	4,2	2700	1200	2010	700	1765	1.188 €	1.188 €	3.549 €	5.453 €	3.817 €
CL2715201	5,5	2700	1500	2010	700	1765	1.232 €	1.240 €	4.110 €	6.315 €	4.419 €
CL2718201	6,8	2700	1800	2010	700	1765	1.853 €	1.862 €	4.449 €	6.837 €	4.784 €
CL2721201	8,1	2700	2100	2010	700	1765	1.923 €	1.915 €	4.869 €	7.482 €	5.236 €
CL2724201	9,4	2700	2400	2010	700	1765	2.288 €	2.257 €	5.348 €	8.165 €	5.750 €
CL2727201	10,7	2700	2700	2010	700	1765	2.400 €	2.373 €	5.756 €	8.846 €	6.190 €
CL2730201	12	2700	3000	2010	700	1765	2.489 €	2.489 €	6.163 €	9.471 €	6.627 €
CL2712220	4,6	2700	1200	2200	700	1765	1.188 €	1.188 €	3.959 €	6.504 €	4.258 €
CL2715220	6,1	2700	1500	2200	700	1765	1.232 €	1.240 €	4.592 €	7.543 €	4.939 €
CL2718220	7,5	2700	1800	2200	700	1765	1.853 €	1.862 €	4.916 €	8.074 €	5.287 €
CL2721220	9,0	2700	2100	2200	700	1765	1.923 €	1.915 €	5.564 €	9.140 €	5.984 €
CL2724220	10,4	2700	2400	2200	700	1765	2.288 €	2.257 €	5.861 €	9.678 €	6.303 €
CL2727220	11,9	2700	2700	2200	700	1765	2.400 €	2.373 €	6.192 €	10.170 €	6.659 €
CL2730220	13,3	2700	3000	2200	700	1765	2.489 €	2.489 €	6.517 €	10.705 €	7.009 €
CL2712240	5,1	2700	1200	2400	700	1765	1.188 €	1.188 €	4.803 €	7.336 €	4.803 €
CL2715240	6,7	2700	1500	2400	700	1765	1.232 €	1.240 €	5.135 €	8.434 €	5.522 €
CL2718240	8,3	2700	1800	2400	700	1765	1.853 €	1.862 €	5.415 €	8.893 €	5.822 €
CL2721240	9,9	2700	2100	2400	700	1765	1.923 €	1.915 €	6.161 €	10.118 €	6.625 €
CL2724240	11,5	2700	2400	2400	700	1765	2.288 €	2.257 €	6.515 €	10.739 €	7.007 €
CL2727240	13,1	2700	2700	2400	700	1765	2.400 €	2.373 €	6.833 €	11.277 €	7.350 €
CL2730240	14,7	2700	3000	2400	700	1765	2.489 €	2.489 €	7.161 €	11.788 €	7.702 €



Tabansız odalarda yükseklik 120 mm düşecektir.
The height of the products without floor is 120 mm less.

120mm SOĞUK ODA YÜKSEKLİKLER / COLD ROOM HEIGHTS : 2010 - 2200 - 2400 mm

Kapı Ölçüleri
Door Dimension
580x1765

Net Kapı Geçiş Ölçüleri / Net Door Passage Dimensions : 700x1765

	1200	1500	1800	2100	2400	2700	3000
1200							
1500							
1800							
2100							
2400							
2700							
3000							

Raf yerleşimi 360mm genişliğinde. / Shelf placement is made for 360mm.
Raflar 4 katlıdır. / Shelf are 4 storeyed.

İç ölçüleri bulmak için 240mm düşülecek. / In order to obtain inside dimensions
240mm must be subtracted to the above measurements.

120mm SOĞUK ODA YÜKSEKLİKLER / COLD ROOM HEIGHTS : 2010 - 2200 - 2400 mm

Kapı Ölçüleri
Door Dimension
580x1765

Net Kapı Geçiş Ölçüleri / Net Door Passage Dimensions : 700x1765

	1200	1500	1800	2100	2400	2700	3000
1200							
1500							
1800							
2100							
2400							
2700							
3000							

Raf yerleşimi 460mm genişliğinde. / Shelf placement is made for 460mm.
Raflar 4 katlıdır. / Shelf are 4 storeyed.

İç ölçüleri bulmak için 240mm düşülecek. / In order to obtain inside dimensions
240mm must be subtracted to the above measurements.

120 mm Oda Paneli / 120 mm Room Panel

NET KAPI GEÇİŞ ÖLÇÜLERİ NET DOOR PASSAGE DIMENSIONS 850X1765



Model	Hacim Volume m ³	Dış Ölçüler External Dimensions			Net Kapı Ölçüsü Net Door Dimensions		360 mm Raflar 360 mm Shelves	460 mm Raflar 460 mm Shelves	Tabansız Oda Fiyatı Price Without Floor	İç 430, Dış 430 Paslanmaz Inside 430, Outside 430 Stainless Steel	Fiyat Price
		W	D	H	W	H					
CL1812201-GN	2,7	1800	1200	2010	850	1765	791 €	778 €	3.487 €	5.287 €	3.700 €
CL1815201-GN	3,5	1800	1500	2010	850	1765	841 €	832 €	3.669 €	5.571 €	3.900 €
CL1818201-GN	4,3	1800	1800	2010	850	1765	1.466 €	1.437 €	4.008 €	6.088 €	4.260 €
CL1821201-GN	5,2	1800	2100	2010	850	1765	1.492 €	1.508 €	4.392 €	6.680 €	4.674 €
CL1824201-GN	6	1800	2400	2010	850	1765	1.536 €	1.551 €	4.696 €	7.144 €	4.999 €
CL1827201-GN	6,8	1800	2700	2010	850	1765	2.176 €	2.149 €	5.112 €	7.785 €	5.448 €
CL1830201-GN	7,7	1800	3000	2010	850	1765	2.261 €	2.238 €	5.416 €	8.252 €	5.774 €
CL1812220-GN	3,0	1800	1200	2200	850	1765	791 €	778 €	3.689 €	6.175 €	3.916 €
CL1815220-GN	3,9	1800	1500	2200	850	1765	841 €	832 €	4.027 €	6.750 €	4.281 €
CL1818220-GN	4,8	1800	1800	2200	850	1765	1.466 €	1.437 €	4.216 €	7.070 €	4.484 €
CL1821220-GN	5,7	1800	2100	2200	850	1765	1.492 €	1.508 €	4.774 €	8.015 €	5.083 €
CL1824220-GN	6,6	1800	2400	2200	850	1765	1.536 €	1.551 €	5.034 €	8.457 €	5.364 €
CL1827220-GN	7,5	1800	2700	2200	850	1765	2.176 €	2.149 €	5.555 €	9.342 €	5.925 €
CL1830220-GN	8,4	1800	3000	2200	850	1765	2.261 €	2.238 €	5.799 €	9.754 €	6.187 €
CL1812240-GN	3,2	1800	1200	2400	850	1765	791 €	778 €	3.839 €	6.431 €	408 €
CL1815240-GN	4,2	1800	1500	2400	850	1765	841 €	832 €	4.436 €	7.443 €	472 €
CL1818240-GN	5,3	1800	1800	2400	850	1765	1.466 €	1.437 €	4.708 €	7.865 €	4.988 €
CL1821240-GN	6,3	1800	2100	2400	850	1765	1.492 €	1.508 €	5.218 €	8.773 €	5.564 €
CL1824240-GN	7,3	1800	2400	2400	850	1765	1.536 €	1.551 €	5.520 €	9.280 €	5.885 €
CL1827240-GN	8,3	1800	2700	2400	850	1765	2.176 €	2.149 €	6.078 €	10.226 €	6.485 €
CL1830240-GN	9,3	1800	3000	2400	850	1765	2.261 €	2.238 €	6.266 €	10.547 €	6.689 €

Model	Hacim Volume m ³	Dış Ölçüler External Dimensions			Net Kapı Ölçüsü Net Door Dimensions		360 mm Raflar 360 mm Shelves	460 mm Raflar 460 mm Shelves	Tabansız Oda Fiyatı Price Without Floor	İç 430, Dış 430 Paslanmaz Inside 430, Outside 430 Stainless Steel	Fiyat Price
		W	D	H	W	H					
CL2112201-GN	3,2	2100	1200	2010	850	1765	833 €	841 €	3.133 €	5.764 €	4.034 €
CL2115201-GN	4,2	2100	1500	2010	850	1765	882 €	895 €	3.344 €	6.088 €	4.260 €
CL2118201-GN	5,1	2100	1800	2010	850	1765	1.545 €	1.590 €	3.727 €	6.680 €	4.674 €
CL2121201-GN	6,1	2100	2100	2010	850	1765	1.585 €	1.568 €	4.183 €	7.378 €	5.163 €
CL2124201-GN	7,1	2100	2400	2010	850	1765	1.833 €	1.821 €	4.545 €	7.932 €	5.551 €
CL2127201-GN	8,1	2100	2700	2010	850	1765	1.925 €	1.910 €	4.869 €	8.432 €	5.901 €
CL2130201-GN	9,1	2100	3000	2010	700	1765	2.030 €	2.022 €	5.397 €	9.242 €	6.468 €
CL2112220-GN	3,5	2100	1200	2200	850	1765	833 €	841 €	3.312 €	6.663 €	4.226 €
CL2115220-GN	4,6	2100	1500	2200	850	1765	882 €	895 €	3.844 €	7.568 €	4.801 €
CL2118220-GN	5,7	2100	1800	2200	850	1765	1.545 €	1.590 €	4.110 €	8.015 €	5.083 €
CL2121220-GN	6,8	2100	2100	2200	850	1765	1.585 €	1.568 €	4.669 €	8.965 €	5.685 €
CL2124220-GN	7,9	2100	2400	2200	850	1765	1.833 €	1.821 €	4.967 €	9.469 €	6.006 €
CL2127220-GN	9,0	2100	2700	2200	850	1765	1.925 €	1.910 €	5.564 €	10.484 €	6.649 €
CL2130220-GN	10,1	2100	3000	2200	700	1765	2.030 €	2.022 €	5.861 €	10.987 €	6.968 €
CL2112240-GN	3,9	2100	1200	2400	850	1765	833 €	841 €	3.662 €	7.258 €	4.602 €
CL2115240-GN	5,1	2100	1500	2400	850	1765	882 €	895 €	4.296 €	8.332 €	5.284 €
CL2118240-GN	6,3	2100	1800	2400	850	1765	1.545 €	1.590 €	4.555 €	8.773 €	5.564 €
CL2121240-GN	7,5	2100	2100	2400	850	1765	1.585 €	1.568 €	5.227 €	9.911 €	6.287 €
CL2124240-GN	8,7	2100	2400	2400	850	1765	1.833 €	1.821 €	5.460 €	10.308 €	6.537 €
CL2127240-GN	9,9	2100	2700	2400	850	1765	1.925 €	1.910 €	6.161 €	11.493 €	7.289 €
CL2130240-GN	11,1	2100	3000	2400	700	1765	2.030 €	2.022 €	6.460 €	12.001 €	7.611 €

Model	Hacim Volume m ³	Dış Ölçüler External Dimensions			Net Kapı Ölçüsü Net Door Dimensions		360 mm Raflar 360 mm Shelves	460 mm Raflar 460 mm Shelves	Tabansız Oda Fiyatı Price Without Floor	İç 430, Dış 430 Paslanmaz Inside 430, Outside 430 Stainless Steel	Fiyat Price
		W	D	H	W	H					
CL2412201-GN	3,7	2400	1200	2010	850	1765	1.130 €	1.130 €	3.903 €	5.926 €	4.148 €
CL2415201-GN	4,9	2400	1500	2010	850	1765	1.182 €	1.178 €	4.320 €	6.566 €	4.596 €
CL2418201-GN	6	2400	1800	2010	850	1765	1.804 €	1.750 €	4.696 €	7.144 €	4.999 €
CL2421201-GN	7,1	2400	2100	2010	850	1765	1.645 €	1.625 €	5.208 €	7.932 €	5.551 €
CL2424201-GN	8,3	2400	2400	2010	850	1765	1.891 €	1.868 €	5.565 €	8.478 €	5.932 €
CL2427201-GN	9,4	2400	2700	2010	850	1765	1.983 €	1.964 €	6.012 €	9.167 €	6.415 €
CL2430201-GN	10,6	2400	3000	2010	700	1765	2.084 €	2.076 €	6.421 €	9.794 €	6.854 €
CL2412220-GN	4,1	2400	1200	2200	850	1765	1.130 €	1.130 €	4.286 €	7.143 €	4.530 €
CL2415220-GN	5,3	2400	1500	2200	850	1765	1.182 €	1.178 €	4.774 €	8.015 €	5.083 €
CL2418220-GN	6,6	2400	1800	2200	850	1765	1.804 €	1.750 €	5.034 €	8.515 €	5.399 €
CL2421220-GN	7,9	2400	2100	2200	850	1765	1.645 €	1.625 €	5.687 €	9.469 €	6.006 €
CL2424220-GN	9,1	2400	2400	2200	850	1765	1.891 €	1.868 €	5.892 €	9.911 €	6.287 €
CL2427220-GN	10,4	2400	2700	2200	850	1765	1.983 €	1.964 €	6.526 €	10.987 €	6.968 €
CL2430220-GN	11,7	2400	3000	2200	700	1765	2.084 €	2.076 €	6.825 €	11.491 €	7.288 €
CL2412240-GN	4,5	2400	1200	2400	850	1765	1.130 €	1.130 €	4.326 €	7.258 €	4.602 €
CL2415240-GN	5,9	2400	1500	2400	850	1765	1.182 €	1.178 €	5.334 €	8.965 €	5.685 €
CL2418240-GN	7,3	2400	1800	2400	850	1765	1.804 €	1.750 €	5.520 €	9.280 €	5.885 €
CL2421240-GN	8,7	2400	2100	2400	850	1765	1.645 €	1.625 €	6.125 €	10.308 €	6.537 €
CL2424240-GN	10,1	2400	2400	2400	850	1765	1.891 €	1.868 €	6.452 €	10.861 €	6.888 €
CL2427240-GN	11,5	2400	2700	2400	850	1765	1.983 €	1.964 €	7.179 €	12.063 €	7.651 €
CL2430240-GN	12,9	2400	3000	2400	700	1765	2.084 €	2.076 €	7.497 €	12.633 €	8.012 €

Model	Hacim Volume m ³	Dış Ölçüler External Dimensions			Net Kapı Ölçüsü Net Door Dimensions		360 mm Raflar 360 mm Shelves	460 mm Raflar 460 mm Shelves	Tabansız Oda Fiyatı Price Without Floor	İç 430, Dış 430 Paslanmaz Inside 430, Outside 430 Stainless Steel	Fiyat Price
		W	D	H	W	H					
CL2712201-GN	4,2	2700	1200	2010	850	1765	1.188 €	1.188 €	4.213 €	6.403 €	4.908 €
CL2715201-GN	5,5	2700	1500	2010	850	1765	1.232 €	1.240 €	4.774 €	7.264 €	5.568 €
CL2718201-GN	6,8	2700	1800	2010	850	1765	1.853 €	1.862 €	5.113 €	7.787 €	5.968 €
CL2721201-GN	8,1	2700	2100	2010	850	1765	1.923 €	1.915 €	5.534 €	8.432 €	6.463 €
CL2724201-GN	9,4	2700	2400	2010	850	1765	2.288 €	2.257 €	6.012 €	9.167 €	7.026 €
CL2727201-GN	10,7	2700	2700	2010	850	1765	2.400 €	2.373 €	6.421 €	9.795 €	7.508 €
CL2730201-GN	12	2700	3000	2010	700	1765	2.489 €	2.489 €	6.827 €	10.420 €	7.987 €
CL2712220-GN	4,6	2700	1200	2200	850	1765	1.188 €	1.188 €	4.624 €	7.761 €	5.392 €
CL2715220-GN	6,1	2700	1500	2200	850	1765	1.232 €	1.240 €	5.256 €	8.836 €	6.136 €
CL2718220-GN	7,5	2700	1800	2200	850	1765	1.853 €	1.862 €	5.580 €	9.384 €	6.518 €
CL2721220-GN	9,0	2700	2100	2200	850	1765	1.923 €	1.915 €	6.228 €	10.568 €	7.340 €
CL2724220-GN	10,4	2700	2400	2200	850	1765	2.288 €	2.257 €	6.526 €	10.987 €	7.631 €
CL2727220-GN	11,9	2700	2700	2200	850	1765	2.400 €	2.373 €	6.856 €	11.546 €	8.021 €
CL2730220-GN	13,3	2700	3000	2200	700	1765	2.489 €	2.489 €	7.182 €	12.099 €	8.404 €
CL2712240-GN	5,1	2700	1200	2400	850	1765	1.188 €	1.188 €	5.468 €	8.621 €	5.988 €
CL2715240-GN	6,7	2700	1500	2400	850	1765	1.232 €	1.240 €	5.799 €	9.754 €	6.775 €
CL2718240-GN	8,3	2700	1800	2400	850	1765	1.853 €	1.862 €	6.079 €	10.228 €	7.104 €
CL2721240-GN	9,9	2700	2100	2400	850	1765	1.923 €	1.915 €	6.826 €	11.493 €	7.984 €
CL2724240-GN	11,5	2700	2400	2400	850	1765	2.288 €	2.257 €	7.179 €	12.063 €	8.380 €
CL2727240-GN	13,1	2700	2700	2400	850	1765	2.400 €	2.373 €	7.498 €	12.636 €	8.778 €
CL2730240-GN	14,7	2700	3000	2400	700	1765	2.489 €	2.489 €	7.826 €	13.191 €	9.162 €

Tabansız odalarda yükseklik 120 mm düşecektir.
The height of the products without floor is 120 mm less.

Model	Hacim Volume m ³	Dış Ölçüler External Dimensions			Net Kapı Ölçüsü Net Door Dimensions		360 mm Raflar 360 mm Shelves	460 mm Raflar 460 mm Shelves	Tabansız Oda Fiyatı Price Without Floor	İç 430, Dış 430 Paslanmaz Inside 430, Outside 430 Stainless Steel	Fiyat Price
		W	D	H	W	H					
CL3012201-GN	4,7	3000	1200	2010	850	1765	1.234 €	1.238 €	4.510 €	6.858 €	4.800 €
CL3015201-GN	6,2	3000	1500	2010	850	1765	1.286 €	1.290 €	4.958 €	7.546 €	5.282 €
CL3018201-GN	7,7	3000	1800	2010	850	1765	1.907 €	1.895 €	5.417 €	8.254 €	5.775 €
CL3021201-GN	9,1	3000	2100	2010	850	1765	1.980 €	1.968 €	5.972 €	9.104 €	6.371 €
CL3024201-GN	10,6	3000	2400	2010	850	1765	2.006 €	1.999 €	6.421 €	9.794 €	6.854 €
CL3027201-GN	12	3000	2700	2010	850	1765	2.439 €	2.427 €	6.826 €	10.416 €	7.289 €
CL3030201-GN	13,5	3000	3000	2010	700	1765	2.539 €	2.535 €	7.751 €	11.838 €	8.285 €
CL3012220-GN	5,2	3000	1200	2200	850	1765	1.234 €	1.238 €	4.884 €	8.202 €	5.202 €
CL3015220-GN	6,8	3000	1500	2200	850	1765	1.286 €	1.290 €	5.465 €	9.186 €	5.826 €
CL3018220-GN	8,4	3000	1800	2200	850	1765	1.907 €	1.895 €	6.265 €	10.544 €	6.688 €
CL3021220-GN	10,1	3000	2100	2200	850	1765	1.980 €	1.968 €	6.515 €	10.987 €	6.968 €
CL3024220-GN	11,7	3000	2400	2200	850	1765	2.006 €	1.999 €	6.826 €	11.493 €	7.289 €
CL3027220-GN	13,3	3000	2700	2200	850	1765	2.439 €	2.427 €	7.182 €	12.099 €	7.674 €
CL3030220-GN	14,9	3000	3000	2200	700	1765	2.539 €	2.535 €	8.257 €	13.922 €	8.829 €
CL3012240-GN	5,7	3000	1200	2400	850	1765	1.234 €	1.238 €	5.384 €	9.050 €	5.740 €
CL3015240-GN	7,5	3000	1500	2400	850	1765	1.286 €	1.290 €	5.734 €	9.643 €	6.116 €
CL3018240-GN	9,3	3000	1800	2400	850	1765	1.907 €	1.895 €	6.265 €	10.544 €	6.688 €
CL3021240-GN	11,1	3000	2100	2400	850	1765	1.980 €	1.968 €	7.125 €	12.001 €	7.611 €
CL3024240-GN	12,9	3000	2400	2400	850	1765	2.006 €	1.999 €	7.497 €	12.633 €	8.012 €
CL3027240-GN	14,7	3000	2700	2400	850	1765	2.439 €	2.427 €	7.826 €	13.191 €	8.366 €
CL3030240-GN	16,5	3000	3000	2400	700	1765	2.539 €	2.535 €	8.640 €	14.570 €	9.241 €



120mm SOĞUK ODA YÜKSEKLİKLER / COLD ROOM HEIGHTS : 2010 - 2200 - 2400 mm

Net Kapı Geçiş Ölçüleri / Net Door Passage Dimensions :850x1765

	1800	2100	2400	2700	3000
1200					
1500					
1800					
2100					
2400					
2700					
3000					

Raf yerleşimi 360mm genişliğinde. / Shelf placement is made for 360mm.
Raflar 4 katlıdır. / Shelf are 4 storeyed.

İç ölçüleri bulmak için 240mm düşülecek. / In order to obtain inside dimensions
240mm must be subtracted to the above measurements.

120mm SOĞUK ODA YÜKSEKLİKLER / COLD ROOM HEIGHTS : 2010 - 2200 - 2400 mm

Net Kapı Geçiş Ölçüleri / Net Door Passage Dimensions :850x1765

	1800	2100	2400	2700	3000
1200					
1500					
1800					
2100					
2400					
2700					
3000					

Raf yerleşimi 460mm genişliğinde. / Shelf placement is made for 460mm.
Raflar 4 katlıdır. / Shelf are 4 storeyed.

İç ölçüleri bulmak için 240mm düşülecek. / In order to obtain inside dimensions
240mm must be subtracted to the above measurements.

80 mm Yan Yana Paneller

80 mm Side By Side Panels

80mm YANA YANA PANELLER YÜKSEKLİKLER : 2010 - 2200 - 2400 mm
80mm SIDE BY SIDE PANELS : 2010 - 2200 - 2400 mm

Net Kapı Geçiş Ölçüleri / Net Door Passage Dimensions : 700x1845

Model	Hacim Volume	Dış Ölçüler External Dimensions			Net Kapı Ölçüsü Net Door Dimensions		360 mm Raflar 360 mm Shelves	460 mm Raflar 460 mm Shelves	İç 430, Dış 430 Paslanmaz Inside 430, Outside 430 Stainless Steel	Fiyat Price
		W	D	H	W	H				
CR3015201-SC	3.5--3.3	3000	1500	2010	700	1845	947 €	957 €	9.011 €	6.259 €
CR3618201-SC	5.2--5.0	3600	1800	2010	700	1845	2.795 €	2.771 €	9.954 €	6.914 €
CR4221201-SC	7.2--7.0	4200	2100	2010	700	1845	3.743 €	3.732 €	12.017 €	8.347 €
CR4824201-SC	9.6--9.3	4800	2400	2010	700	1845	4.239 €	4.221 €	1.397 €	9.702 €
CR5424201-SC	10.9--10.5	5400	2400	2010	700	1845	4.523 €	4.501 €	16.345 €	11.353 €
CR6030201-SC	15.5--14.9	6000	3000	2010	700	1845	5.050 €	5.031 €	19.645 €	13.653 €
CR3015220-SC	3.9--3.7	3000	1500	2200	700	1845	947 €	957 €	9.639 €	6.696 €
CR3618220-SC	5.8--5.6	3600	1800	2200	700	1845	2.795 €	2.771 €	10.582 €	7.351 €
CR4221220-SC	8.0--7.8	4200	2100	2200	700	1845	3.743 €	3.732 €	12.516 €	8.784 €
CR4824220-SC	10.6--10.3	4800	2400	2200	700	1845	4.239 €	4.221 €	14.596 €	10.138 €
CR5424220-SC	12.0--11.6	5400	2400	2200	700	1845	4.523 €	4.501 €	16.974 €	11.790 €
CR6030220-SC	17.0--16.4	6000	3000	2200	700	1845	5.050 €	5.031 €	20.284 €	14.090 €
CR3015240-SC	4.3--4.1	3000	1500	2400	700	1845	947 €	957 €	10.687 €	7.423 €
CR3618240-SC	6.3--6.1	3600	1800	2400	700	1845	2.795 €	2.771 €	11.630 €	8.079 €
CR4221240-SC	8.8--8.6	4200	2100	2400	700	1845	3.743 €	3.732 €	13.694 €	9.512 €
CR4824240-SC	11.6--11.3	4800	2400	2400	700	1845	4.239 €	4.221 €	14.741 €	10.239 €
CR5424240-SC	13.1--12.7	5400	2400	2400	700	1845	4.523 €	4.501 €	18.021 €	12.518 €
CR6030240-SC	18.5--18.0	6000	3000	2400	700	1845	5.050 €	5.031 €	21.374 €	14.847 €

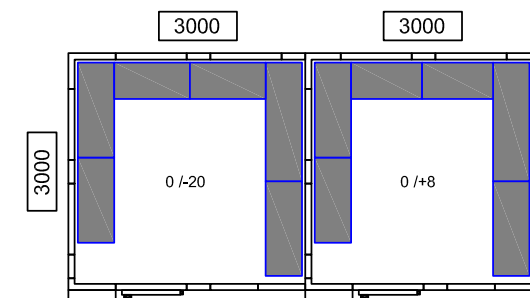
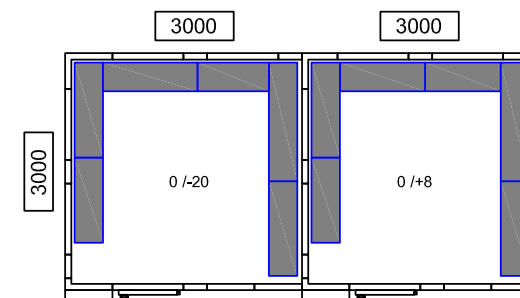
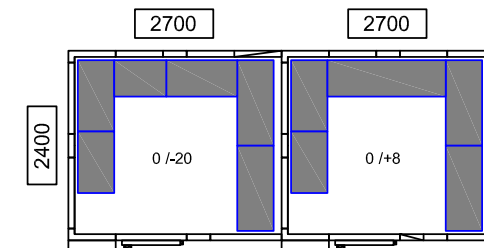
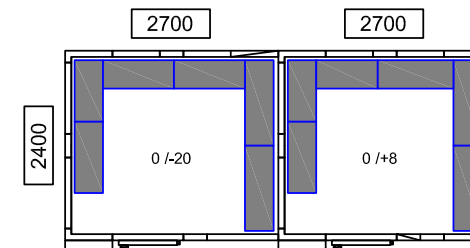
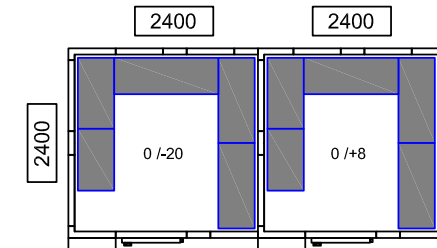
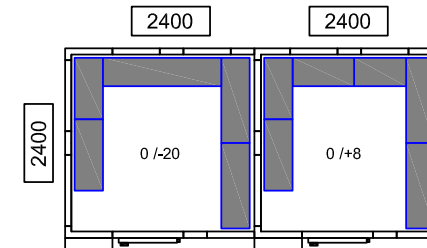
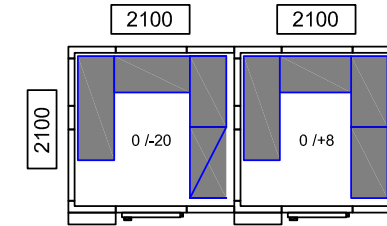
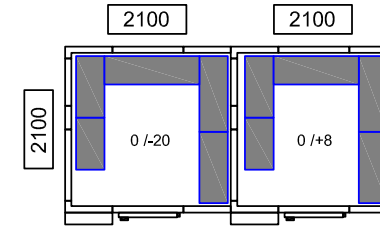
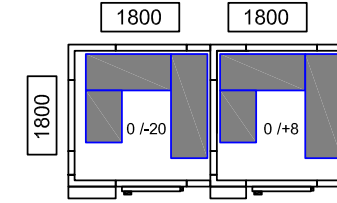
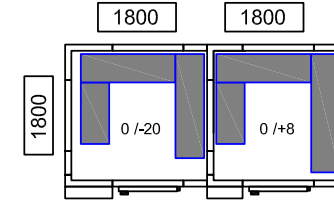
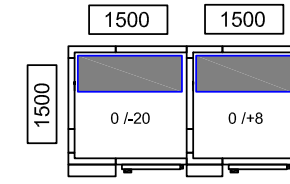
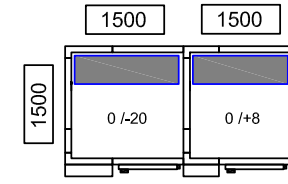

Raf yerleşimi 360mm genişliğinde.Raflar 4 katlıdır.
Shelf placement is made for 360mm.Shelf are 4 storeyed.

Raf yerleşimi 460mm genişliğinde.Raflar 4 katlıdır.
Shelf placement is made for 460mm.Shelf are 4 storeyed.

120 mm Yan Yana Paneller

120 mm Side By Side Panels

Model	Hacim Volume	Dış Ölçüler External Dimensions			Net Kapı Ölçüsü Net Door Dimensions		360 mm Raflar 360 mm Shelves	460 mm Raflar 460 mm Shelves	İç 430, Dış 430 Paslanmaz Inside 430, Outside 430 Stainless Steel	Fiyat Price
		W	D	H	W	H				
CL3015201-SC	3.1--2.8	3000	1500	2010	700	1765	906 €	911 €	10.478 €	7.278 €
CL3618201-SC	4.6--4.3	3600	1800	2010	700	1765	2.620 €	2.574 €	12.172 €	8.455 €
CL4221201-SC	6.5--6.1	4200	2100	2010	700	1765	3.337 €	3.323 €	14.669 €	10.189 €
CL4824201-SC	8.7--8.2	4800	2400	2010	700	1765	4.248 €	4.200 €	16.974 €	11.790 €
CL5424201-SC	9.9--9.4	5400	2400	2010	700	1765	4.379 €	4.374 €	19.279 €	13.100 €
CL6030201-SC	14.0--13.5	6000	3000	2010	700	1765	5.005 €	4.992 €	20.601 €	15.869 €
CL3015220-SC	3.4--3.1	3000	1500	2200	700	1765	906 €	911 €	10.897 €	7.569 €
CL3618220-SC	5.1--4.8	3600	1800	2200	700	1765	2.620 €	2.574 €	12.573 €	8.733 €
CL4221220-SC	7.2--6.8	4200	2100	2200	700	1765	3.337 €	3.323 €	14.983 €	10.408 €
CL4824220-SC	9.7--9.2	4800	2400	2200	700	1765	4.248 €	4.200 €	17.393 €	12.081 €
CL5424220-SC	10.9--10.4	5400	2400	2200	700	1765	4.379 €	4.374 €	19.279 €	13.391 €
CL6030220-SC	15.6--14.9	6000	3000	2200	700	1765	5.005 €	4.992 €	24.936 €	17.321 €
CL3015240-SC	3.8--3.4	3000	1500	2400	700	1765	906 €	911 €	11.525 €	8.005 €
CL3618240-SC	5.7--5.3	3600	1800	2400	700	1765	2.620 €	2.574 €	13.202 €	9.170 €
CL4221240-SC	8.0--7.5	4200	2100	2400	700	1765	3.337 €	3.323 €	15.716 €	10.917 €
CL4824240-SC	10.6--10.1	4800	2400	2400	700	1765	4.248 €	4.200 €	18.663 €	12.962 €
CL5424240-SC	12.0--11.5	5400	2400	2400	700	1765	4.379 €	4.374 €	20.997 €	14.585 €
CL6030240-SC	17.2--16.5	6000	3000	2400	700	1765	5.005 €	4.992 €	25.712 €	17.860 €

120mm YANA YANA PANELLER YÜKSEKLİKLER : 2010 - 2200 - 2400 mm
120mm SIDE BY SIDE PANELS : 2010 - 2200 - 2400 mm

Net Kapı Geçiş Ölçüleri / Net Door Passage Dimensions : 700x1765

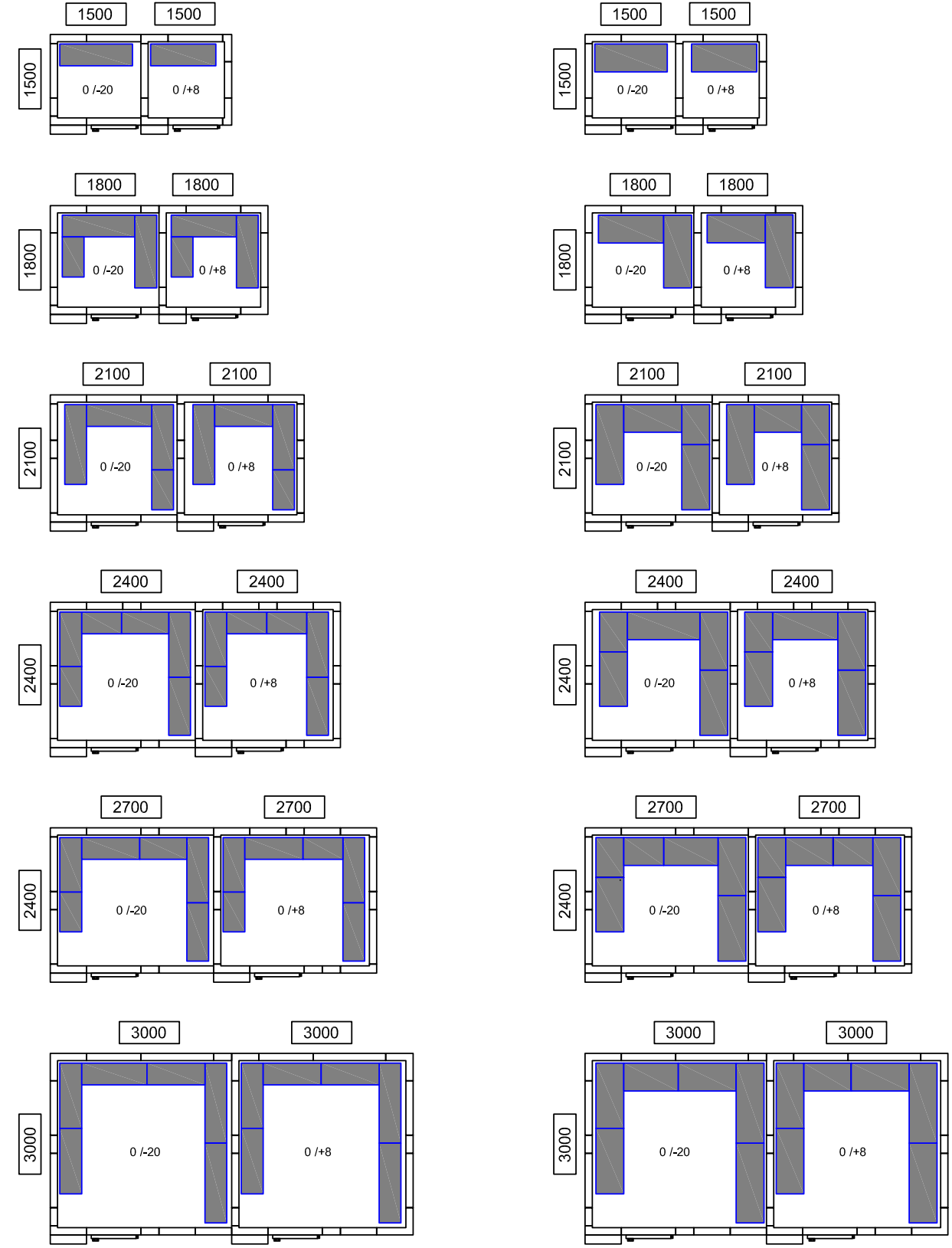

Raf yerleşimi 360mm genişliğinde. Raflar 4 katlıdır.
Shelf placement is made for 360mm. Shelf are 4 storeyed.

Raf yerleşimi 460mm genişliğinde. Raflar 4 katlıdır.
Shelf placement is made for 460mm. Shelf are 4 storeyed.

120 mm Geçmeli Paneller

120 mm Pass Through Panels

Model	Hacim Volume	Dış Ölçüler External Dimensions			Net Kapı Ölçüsü Net Door Dimensions		360 mm Raflar 360 mm Shelves	460 mm Raflar 460 mm Shelves	İç 430, Dış 430 Paslanmaz Inside 430, Outside 430 Stainless Steel	Fiyat Price
		W	D	H	W	H				
CL1527201-PC	2.8--2.4	1500	2700	2010	700	1765	776 €	762 €	9.430 €	6.550 €
CL1830201-PC	4.3--3.0	1800	3000	2010	700	1765	1.299 €	1.285 €	11.001 €	7.642 €
CL2133201-PC	6.1--3.6	2100	3300	2010	700	1765	1.495 €	1.482 €	12.740 €	8.850 €
CL2436201-PC	8.3--4.1	2400	3600	2010	700	1765	1.951 €	1.933 €	14.616 €	10.152 €
CL1527220-PC	3.1--2.7	1500	2700	2200	700	1765	776 €	762 €	10.300 €	7.154 €
CL1830220-PC	4.8--3.3	1800	3000	2200	700	1765	1.299 €	1.285 €	11.882 €	8.254 €
CL2133220-PC	6.8--3.9	2100	3300	2200	700	1765	1.495 €	1.482 €	13.177 €	9.651 €
CL2436220-PC	9.1--4.6	2400	3600	2200	700	1765	1.951 €	1.933 €	15.916 €	11.581 €
CL1527240-PC	3.4--2.9	1500	2700	2400	700	1765	776 €	762 €	11.231 €	7.802 €
CL1830240-PC	5.3--3.6	1800	3000	2400	700	1765	1.299 €	1.285 €	13.024 €	9.046 €
CL2133240-PC	7.5--4.4	2100	3300	2400	700	1765	1.495 €	1.482 €	15.140 €	10.517 €
CL2436240-PC	10.0--5.0	2400	3600	2400	700	1765	1.951 €	1.933 €	17.347 €	12.049 €

120mm GEÇMELİ PANELLER YÜKSEKLİKLER : 2010 - 2200 - 2400 mm

120mm PASS THROUGH PANELS : 2010 - 2200 - 2400 mm

Net Kapı Geçiş Ölçüleri / Net Door Passage Dimensions : 700x1765

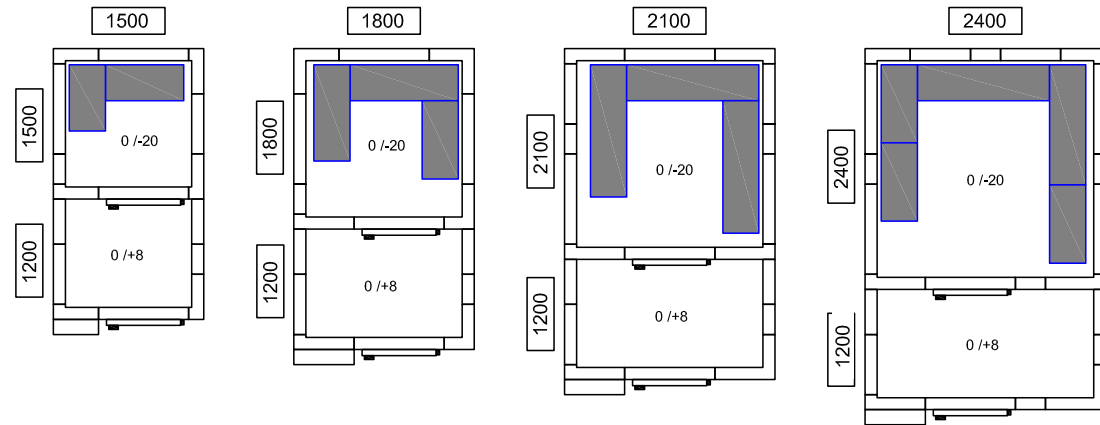

Raf yerleşimi 360mm genişliğinde,Raflar 4 katlıdır.
Shelf placement is made for 360mm.Shelf are 4 storeyed.

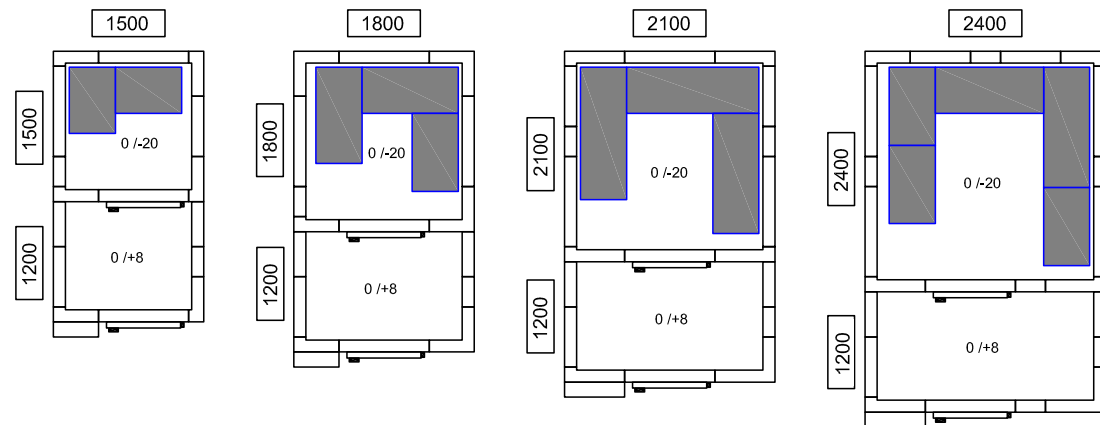

Raf yerleşimi 460mm genişliğinde,Raflar 4 katlıdır.
Shelf placement is made for 460mm.Shelf are 4 storeyed.

Soğutma Üniteleri / Cooling Unit

Soğutma Kapasitesi

Ambient Temperature		25°C	30°C	35°C	38°C	43°C
Set Temperature		0 / +8	0 / +8	0 / +8	0 / +8	0 / +8
Product	Room Volume m³	Cooling Capacity (W) m³	Cooling Capacity (W) m³	Cooling Capacity (W) m³	Cooling Capacity (W) m³	Cooling Capacity (W) m³
SGN-PGN-3050	3 - 5 m³	1289 - 10,61	1173 - 7,83	1059 - 5,97	1009 - 5,00	904 - 3,83
SGN-PGN-5175	5.1 - 7,5 m³	1647 - 16,93	1544 - 12,08	1435 - 8,91	1367 - 7,50	1250 - 5,70
SGN-PGN-7610	7,6 - 10 m³	1734 - 21,95	1638 - 15,78	1540 - 11,77	1480 - 10,00	1379 - 7,74
SGN-PGN-1015	10.1 - 15 m³	1946 - 32,91	1839 - 23,66	1729 - 17,65	1662 - 15,00	1548 - 11,61
SGN-PGN-1520	15.1 - 20 m³	2178 - 46,41	2009 - 32,56	1849 - 23,78	1759 - 20,00	1620 - 15,30

Under asrae conditions / Subcooling 8.3 K, Return Gas 35 °C.

Soğutma Kapasitesi

Ambient Temperature		25°C	30°C	35°C	38°C	43°C
Set Temperature		0 / +8	0 / +8	0 / +8	0 / +8	0 / +8
Product	Room Volume m³	Cooling Capacity (W) m³	Cooling Capacity (W) m³	Cooling Capacity (W) m³	Cooling Capacity (W) m³	Cooling Capacity (W) m³
SGL-PGL-3050	3 - 5 m³	779 - 8,25	744 - 6,75	706 - 5,58	682 - 5,00	639 - 4,18
SGL-PGL-5175	5.1 - 7,5 m³	944 - 12,39	905 - 10,14	863 - 8,38	836 - 7,50	789 - 6,25
SGL-PGL-7610	7,6 - 10 m³	1176 - 16,16	1137 - 13,34	1093 - 11,11	1065 - 10,00	1013 - 8,40
SGL-PGL-1015	10.1 - 15 m³	1331 - 23,69	1291 - 19,72	1245 - 16,58	1213 - 15,00	1154 - 12,74
SGL-PGL-1520	15.1 - 20 m³	1626 - 31,89	1581 - 26,48	1528 - 22,18	1492 - 20,00	1427 - 16,90

Calculation Condition: Liquid 32.2 °C, Return Gas 32.2 °C.

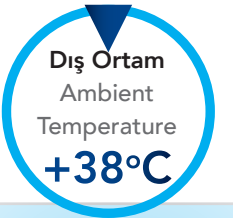

Mono - Blok Soğutma Sistemi

MODEL	Oda Hacmi Room Volume m³	İç Sıcaklık Temperature °C	Gerilim Tension V	Güç Power Hp	Gaz Gas	Fiyat Price
PGN3050	3 - 5	0 / +8	230/50 Hz	1/2 HP	R290	2.164 €
PGN5175	5,1 - 7,5	0 / +8	230/50 Hz	1/2 HP	R290	2.214 €
PGN7610	7,6 - 10	0 / +8	230/50 Hz	3/4 HP	R290	2.369 €
PGN1015	10,1 - 15	0 / +8	230/50 Hz	3/4 HP	R290	2.728 €
PGN1520	15,1 - 20	0 / +8	230/50 Hz	1 HP	R290	3.083 €

MODEL	Oda Hacmi Room Volume m³	İç Sıcaklık Temperature °C	Gerilim Tension V	Güç Power Hp	Gaz Gas	Fiyat Price
PGL3050	3 - 5	0 / -20	230/50 Hz	1-1/2 HP	R290	2.523 €
PGL5175	5,1 - 7,5	0 / -20	230/50 Hz	1-1/2 HP	R290	2.548 €
PGL7610	7,6 - 10	0 / -20	230/50 Hz	2 HP	R290	3.296 €
PGL1015	10,1 - 15	0 / -20	230/50 Hz	2 HP	R290	3.398 €
PGL1520	15,1 - 20	0 / -20	230/50 Hz	2-1/2 HP	R290	3.713 €

Fiyatlar Montaj Hariç fiyatlardır. / All prices are without assembly.
R452A Soğutucu Gaz Opsiyonu Mevcuttur. / R452A Cooling Gass Options is Available.



Split Soğutma Sistemi

MODEL	Oda Hacmi Room Volume m³	İç Sıcaklık Temperature °C	Gerilim Tension V	Güç Power Hp	Gaz Gas	Fiyat Price
SPN3075	3 - 7,5	0 / +8	230/50 Hz	1/2 HP	R452	2.868 €
SPN7615	7,6 - 15	0 / +8	230/50 Hz	3/4 HP	R452	3.259 €
SPN1520	15,1 - 20	0 / +8	230/50 Hz	1 HP	R452	3.520 €

MODEL	Oda Hacmi Room Volume m³	İç Sıcaklık Temperature °C	Gerilim Tension V	Güç Power Hp	Gaz Gas	Fiyat Price
SPL3075	3 - 7,5	0 / -20	230/50 Hz	1-1/2 HP	R452	3.651 €
SPL7615	7,6 - 15	0 / -20	380/50 Hz	2 HP	R452	5.214 €
SPL1520	15,1 - 20	0 / -20	380/50 Hz	2-1/2 HP	R452	5.867 €

Fiyatlar Montaj Hariç fiyatlardır. / All prices are without assembly.
Fiyatlar 10 mt. uzaklığa göre verilmiştir. Daha uzak sistemler için fiyat sorunuz.
Prices are for max. 10 meter away. For systems longer than this please ask for price.

Modüler Soğuk Oda / Modular Cold Rooms

Kolay Montaj / Easy Assambly



Raf Ölçüleri / Shelf Dimensions

Genişlik Width (cm)	Derinlik / Depth (cm)	
	36	46
70	TS-7036-H	TS-7046-H
80	TS-8036-H	TS-8046-H
90	TS-9036-H	TS-9046-H
100,5	TS-100536-H	TS-100456-H
110,5	TS-110536-H	TS-110546-H
120,5	TS-120536-H	TS-120546-H
130,5	TS-130536-H	TS-130546-H
141	TS-14136-H	TS-14146-H
151	TS-15136-H	TS-15146-H
161	TS-16136-H	TS-16146-H
171	TS-17136-H	TS-17146-H
Köşe Aparatı / Angle piece	B01RF63235	B01RF63235
	Frenox code	Frenox code

* Raf fiyatları projeye göre belirlenecektir. / Shelf prices will be calculated according to the project.

Özellikler

- * Patentli dikey ve yatay raf sistemi
- * "L", "U", "T" ve "+" şeklinde montaj olanağı
- * Kolay Montaj
- * Gıdaya uygun, (-30 C / +90 C) dayanıklı

* 90kg/ 1kat ve 450kb 2 direk arası yüklenme

Kullanım Alanları

- * Soğuk Odalar
- * Laboratuvarlar
- * Ketring

Info

- * Famous system patented uprights / horizontal shelf rails.
- * Allowing "L", "U", "T" and "+" layouts.
- * Easy and Quickly assembly
- * Highest hygienic standarts, dishwasher safe (-30 C / +90 C)

*90kg/level and 450kg between 2 uprights

Usage Areas

- * Cold rooms
- * Laboratories
- * Catering



Opsiyonlar / Options



307
€



Akıllı Frenox Buzdolabı:

İnternet bağlantılı, Frenox Smart buzdolapları bulut sistemini kullanarak, ürünü dünyanın her bir tarafından kontrolünü sağlamaktadır. Bu platform EVC kontrol paneline entegre edilmiştir. İnternet sağlayıcınızın Wi-Fi özelliğini kullanarak kontrol cihazını internete bağlayabilir ve cep telefonunuzda veya bilgisayarınızda set derecesini, alarmları, parametreleri ve soğutma döngüsünü kontrol edebilirsiniz. Buradan bulut platformuna dayalı uzaktan izleme sistemi olan EVlink (Android) uygulamasını indiriniz gerekmektedir. Frenox Smart, buzdolapları, derin dondurucular ve soğuk oda depolarında gıda koruma saklama ihtiyaçlarını en iyi şekilde karşılamaktadır. Gerekli olan tek şey, özel bir sürücüye sahip FRENOX EVC kontrol panellerini bulut sistemine bağlayıp ve cihazları bir PC, tablet veya akıllı telefon yardımı ile uzaktan yönetilmesini mümkün kılan basit bir Wi-Fi internet bağlantısını kullanmaktır.

Frenox Smart Line:

Frenox smart line, known as internet connected refrigerator. By using special features and cloud system you can control the product from all around the world. Smart line is integrated to our EVC controllers. By using the Wi-Fi of the construction you can connect the controller to the internet and control the set degree, alarms, parameters and cooling cycle with your mobile phone or PC. Here you must download EVlink (Android) application which is a remote monitoring system based on a cloud platform. Frenox Smart meets the needs of the food preservation and cooking sector, from refrigerated units to food equipment. All that is needed is a simple onsite Wi-Fi internet connection to enable FRENEX EVC controllers with special drivers to connect to the cloud system, making it possible to remotely manage equipment from a PC, tablet or smartphone.

